

INSTRUCTION MANUAL FT-690R



**YAESU ELECTRONICS CORP.
P.O. BOX 49
PARAMOUNT, CA 90723
U.S.A.**

**YAESU MUSEN CO., LTD.
C.P.O. BOX 1500
TOKYO, JAPAN**



TABLE OF CONTENTS

	(Page)
INTRODUCTION	1
SPECIFICATIONS	2
SEMICONDUCTORS	3
ACCESSORIES	3
FRONT PANEL CONTROLS AND SWITCHES	4
REAR APRON SWITCHES AND JACKS	8
SIDE PANEL JACKS	10
INTERNAL SWITCHES	11
OPERATION	14
CIRCUIT DESCRIPTION	25
MAINTENANCE AND ALIGNMENT	32
PARTS LIST	46

FT-690R

6 METER PORTABLE TRANSCEIVER



INTRODUCTION

The FT-690R is a highly sophisticated, compact multi-mode transceiver for the 6 meter amateur band. Featuring PLL synthesis in 100 Hz, 1 kHz, 10 kHz, or 20 kHz steps, the FT-690R utilizes a Liquid Crystal Display for digital readout of the operating frequency. Ten memories, scanning of the band or memory channels, two VFOs, and receiver offset tuning make the FT-690R a significant breakthrough in technology.

Powered by eight "C" size dry cells or Ni-Cd batteries (not supplied), the FT-690R is completely self-contained and portable. A telescoping whip antenna is built into the FT-690R, for convenient portable operation. And a high-performance noise blanker is also included, for minimizing interference caused by impulse noise.

Power output is 2.5 watts (AM: 0.8W), switchable to 0.5 watt (AM: 0.2W) for battery conservation. For memory backup purposes, a lithium cell is included, providing an estimated lifetime of five years because of the extremely low current consumption of the memory circuitry. The light weight, portability, and efficiency of the FT-690R make it suitable for emergency FM work, or vacation enjoyment.

We recommend that you read this manual in its entirety, so as to understand more completely the many features of the exciting new FT-690R. With proper care in operation, this equipment will provide many years of reliable performance.

SPECIFICATIONS

MEMO

GENERAL

Frequency coverage:

50 – 54 MHz

Modes of operation

SSB (USB), CW, AM and FM

Synthesizer steps:

SSB/CW/AM: 100 Hz, 1 kHz

FM: 10 kHz, 20 kHz

Power requirements:

8 x C - size dry battery cells or

8 x C - size Ni-Cd battery cells

External: 8.5 – 15.2 V DC

Memory backup: built-in lithium battery cell

Current consumption:

60mA on receive;

800mA on transmit (2.5W RF, FM)

Antenna impedance:

50 ohms

Case size:

58(H) x 150(W) x 195(D) mm

Weight:

1.3kg. without batteries

TRANSMITTER

Power output:

2.5 watts at 12 volts

(AM 0.8 watts)

Carrier suppression:

Better than 40 dB

Spurious radiation:

Better than 60 dB

Unwanted sideband suppression:

Better than 40 dB

Tone burst frequency:

1800 Hz

Frequency response:

300 – 2700 Hz (–6 dB)

FM deviation:

±5 kHz

Microphone impedance:

600 ohms

RECEIVER

Circuit type:

SSB/CW: Single conversion
superheterodyne

AM/FM: Double conversion
superheterodyne

Intermediate frequencies:

1st IF 10.81 MHz

2nd IF 455 kHz (AM/FM)

Sensitivity:

SSB/CW/AM: 0.5 μ V for 20 dB S/N

FM: 0.25 μ V for 12 dB SINAD

Selectivity:

SSB/CW: 2.4 kHz at 6 dB down;

4.1 kHz at 60 dB down

AM: 4 kHz at 6 dB down;

15 kHz at 60 dB down

FM: 14 kHz at 6 dB down;

25 kHz at 60 dB down

Image reduction:

Better than –60 dB

Audio output impedance:

8 ohms

Audio output:

1 watt @10% THD

Specifications subject to change without notice or obligation.

RESISTOR		
R8001	J01215223	Carbon Film 1/8W TJ 22kΩ
R8004	J01215333	" " " " 33kΩ
R8002	J00215473	" " " VJ 47kΩ
R8003	J01215474	" " " TJ 470kΩ
CAPACITOR		
C8001, 8002	K14179002	Ceramic Disc 50WV 0.01μF (RD204YM103Z50V)
SWITCH		
SW8001	N6090007	SSS013
SW8002	N6090008	SSS012
ACCESSORIES		
Symbol No.	Part No.	Description
	M3090033	Microphone YM-47
	P1090253	(Microphone Plug FM147P)
	R7070600	Shoulder Belt
	R0071360	Microphone Hanger
	P1090139	Power Plug P-200
	P0090034	SP Plug C-107

SEMICONDUCTORS

ICs:

HD44820A18	1
ICL7660CPA	1
MC1496P	1
MC3357P	1
MC14001B	1
MC14069UB	2
TC5082P	1
TP0401	1
μPC575-C2	1
μPC577H	1
μPD2819-C	1

Transistors:

2SA733P	2
2SA733Q	1
2SC496Y	1
2SC535A	5
2SC945P	4
2SC1583	1
2SC1947	1
2SC2053	1
2SC2603E	22
2SC2786L	3
MPS-A13	1

Diodes:

1S188FM (Ge)	15
1S1555 (Si)	1
1SS53 (Si)	57
10D1 (Si)	1
MI301 (Si)	2
U05B (Si)	2
1SS97	1
(Schottky Barrier)	
1SV50 (Varactor)	1
1SV68 (")	1
1SV69 (")	8
1T25 (")	1
HZ6C-1L (Zener)	1
RD5.6EB-3(")	2
RD6.8EB-3(")	1
TLG205(LED)	1
TLR205(LED)	1

FETs:

2SK30A-Y	1
2SK168D	2
2SK192GR	3
2SK193F	2
2SK193K	1
3SK51-03	1
3SK59GR	1
3SK59Y	1
3SK73Y	4

LCD:

H1313A	1
--------	---

ACCESSORIES

Microphone YM-47 (M3090033)	1
Microphone Hanger (R0071360)	1
Shoulder Strap (R070600)	1
External Power Supply Plug P-200 (P1090139)	1
External Speaker Plug C-107 (P0090034)	1

FRONT PANEL CONTROLS AND SWITCHES

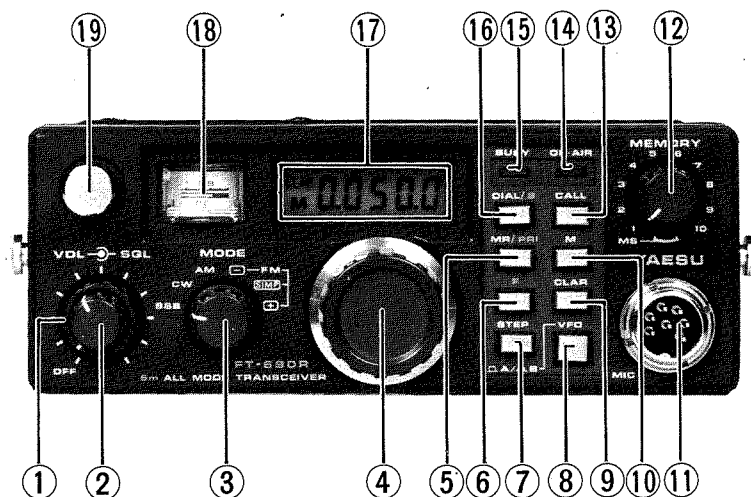

(1) SQL

The squelch control silences the receiver in the FM mode when no stations are being received on the channel in use. The SQL control should only be advanced to the threshold point of background noise silencing; further advancement of this control will lead to reduced sensitivity to weak signals.

(2) VOL

This is the audio gain control for the receiver, as well as the main ON/OFF switch for the transceiver.

(3) MODE

This switch selects the desired mode: SSB (USB), CW, AM or FM.

(4) MAIN DIAL

The main tuning dial is used for selection of operating frequencies using the two main VFOs or the clarifier. In the SSB, CW, and AM modes, synthesizer steps of 100 Hz or 1 kHz are programmed, while on FM the channel steps are 10 kHz or 20 kHz each. In the clarifier mode, the synthesizer moves in 100 Hz steps.

		LCD	
DS6001	G6090025	H1313A	
		LAMP	
PL6001	Q1000046	BQ031-30103A	12V 40mA
KEYBOARD UNIT			
Symbol No.	Part No.	Description	
PB-2238	F0002238	Printed Circuit Board	
	C0022380	P.C.B. with Components	
		DIODE	
D7003-7007	G2090027	Si	1SS53
D7001	G2090136	LED	TLG205
D7002	G2090137	LED	TLR205
		RESISTOR	
R7001	J01215821	Carbon Film	1/8W TJ 820Ω
		SWITCH	
SW7001-7007	N5090003	KEF-10901	
SW7008	N4090042	SUT111	
		CONNECTOR	
J7001	P0090210	S9B-XH	
P7001	P0090242	3022-18A	
SWITCH UNIT (B)			
Symbol No.	Part No.	Description	
PB-2241	F0002241	Printed Circuit Board	
	C0022410	P.C.B. with Components	
		TRANSISTOR	
Q8001	G3326030E	2SC2603E	

(11) MIC

This seven pin jack accepts microphone audio input, the scanning control lines, and the PTT (Push to Talk) control line. Microphone impedance is 500 ohms.

(12) MEMORY

The memory channel selector is used to choose any of the 10 memory channels. In the MS (Memory Scan) position, scanning of the memories may be performed.

(13) CALL

When this button is pressed (FM mode only), a 1800 Hz tone will be superimposed on the microphone line, and the PTT switch line will be grounded, activating the transmitter. This allows manual-length access of repeaters requiring a burst tone.

(14) ON AIR

This indicator lights up while you are transmitting.

(15) BUSY

This indicator lights up when the main squelch is opened up by an incoming signal.

(16) DIAL/S

When the DIAL/S button alone is pushed, tuning is accomplished by the main dial on either VFO-A or VFO-B. If the F button is pushed, then the DIAL/S button, the memory split mode will be selected, for receiving on the memory while transmitting on the VFO.

(17) DIGITAL DISPLAY

The digital display uses a liquid crystal display for indication of the operating frequency and mode. The frequency readout displays the last five digits of the operating frequency, with resolution to 0.1 kHz. Indicators are also provided for indication of clarifier operation ("CLAR"), memory channel operation ("M"), or memory split operation ("- on transmit).

Symbol No.	Part No.	Description
FUSE		
FU4001	Q0000021	L-20 1.5A
FUSE HOLDER		
FU4002, 4003	P2000020	UF-0033
CONNECTOR		
J4001	P0090201	B12B-XH
CONTROL UNIT		
Symbol No. Part No. Description		
PB-2236B	F0002236B	Printed Circuit Board
	C0022360	P.C.B. with Components
IC		
Q5001	G1090349	HD44820-A18
Q5002, 5004	G1090126	MC14069UB
TRANSISTOR		
Q5003	G3326030E	2SC2603E
DIODE		
D5002-5005	G2090027	Si 1SS53
D5006	G2090118	Schottky Barrier 1SS97
RESISTOR		
R5001	J00215271	Carbon Film 1/8W VJ 270 Ω
R5007	J00215102	" " " " 1k Ω
R5019	J00215392	" " " " 3.9k Ω
R5008	J00215562	" " " " 5.6k Ω
R5005	J00215103	" " " " 10k Ω
R5002	J00215273	" " " " 27k Ω
R5017	J00215473	" " " " 47k Ω
R5003, 5006, 5018	J00215104	" " " " 100k Ω
R5011, 5012, 5015	J00215334	" " " " 330k Ω
R5013, 5016	J00215684	" " " " 680k Ω

		DIODE			
D4001, 4004-4006	G2090027	Si	1SS53		
D4002	G2090035	Zener	RD6.8EB-3		
D4003	G2090193	"	RD5.6EB-3		
		CRYSTAL			
X4001(1800Hz)	H0101983	HC-18/T	7.3728 MHz		
		RESISTOR			
R4006	J01215100	Carbon Film	1/8W	TJ	10Ω
R4005	J01215471	" "	" "	" "	470Ω
R4007	J01215102	" "	" "	" "	1kΩ
R4001	J00215222	" "	" "	VJ	2.2kΩ
R4002, 4003	J00215103	" "	" "	" "	10kΩ
		POTENTIOMETER			
VR4001	J50717104	RV8-HAS 100K	100kΩB		
		CAPACITOR			
C4001	K00175150	Ceramic Disc (DD104SL150J50V02)	50WV	SL	15pF
C4002, 4003	K00175330	" " (DD104SL330J50V02)	" "	" "	33pF
C4007, 4009, 4012, 4013, 4016	K14179002	" " (RD204YM103Z50V)	" "	" "	0.01μF
C4006, 4010	K40179005	Electrolytic (50RC2-R47)	" "	" "	0.47μF
C4004, 4005	K40179001	" " (50RC2-1)	" "	" "	1μF
C4011, 4015	K40129012	" " (16RC2-10)	16WV	" "	10μF
C4008, 4014	K40109002	" " (10RE47)	10WV	" "	47μF
		CONNECTOR			
J4001	P0090202	B13BT-XH			
		BATTERY			
BAT4001	Q9000106	CR2025	3V	35mAh	

(18) S/PO

The meter allows determination of incoming signal strength and relative power output. The meter is also used for checking battery operation.

(19) WHIP ANTENNA

The built-in whip antenna is satisfactory for most portable operation. When using an external antenna, the whip should be telescoped fully into the transceiver. Conversely, when an external antenna is not used, the whip should always be fully extended.

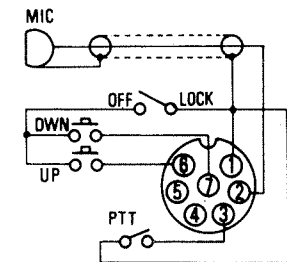
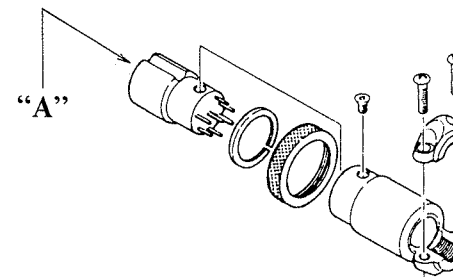

Viewed from "A" Side

YM-47 MICROPHONE PLUG CONNECTIONS

C1092, 1094, 1131, 3048	K40149011	Electrolytic (25RC2-4R7)	25WV	4.7 μ F
C1064, 1087, 1104, 1107, 1122, 1123, 2004, 2007, 2011, 2019, 2021-2023, 2075, 2086, 2093, 2096, 2109, 3010, 3045, 3056, 3057	K40129012	" (16RC2-10)	16WV	10 μ F
C1128, 1132, 1137	K40109002	" (10RE47)	10WV	47 μ F
C1134	K40129007	" (16RE100)	16WV	100 μ F
C1136	K40129021	" (16R102S 13x16)	"	1000 μ F
C3033	K70167474	Tantalum (CS15E1VR47)	35WV	0.47 μ F
C2020	K70127106	" (CS15E1C100M)	16WV	10 μ F
C3034	K54200001	Polyester Film (B32561-A1105J)	100WV	1 μ F
TRIMMER CAPACITOR				
TC3001	K91000056	TZ03Z070A	7pF	
TC1002, 1003, 2007	K91000029	ECV-1ZW 20x53	20pF	
TC2004, 2006	K91000030	ECV-1ZW 40x53	40pF	
TC2005	K91000058	2222-808-61809	80pF	
INDUCTOR				
L3003	L1190004	FL 4H-R68M	0.68 μ H	
L3009	L1190009	FL 4H-3R3M	3.3 μ H	
L3004, 3008	L1190005	FL 4H-1R0M	1 μ H	
L1003, 2011	L1190111	FL 4H-5R6K	5.6 μ H	
L3006	L1190014	FL 4H-100K	10 μ H	
L3010	L1190073	FL 5H-270K	27 μ H	
L1001	L1190016	FL 5H-101K	100 μ H	
L1004, 1005	L1190120	FL 5H-471K	470 μ H	
L2001	L1190102	S-104K	100mH	
L2003	L1020683			
L2006	L0020744			
L3005	L0020774			
L2002	L0020775			
L2008	L0020828			
L2009	L0020688			
L2010	L0020743			
L2012	L0020981	T25-10		
L2013, 2014	L0020979	T25-10		
L3002	L0190017	E521-GN-110053		

(4) HI/LOW

This switch selects power outputs of 2.5 watts (HI) or 0.5 watt (LOW).

(5) CASE LATCH

This mechanism provides easy opening and closing of the cabinet for battery removal.

(6) EXT DC 13.8V

Use this jack for connection to an external DC supply. Never exceed 15 volts at this jack, and never apply AC power of any kind at this point. Also, be absolutely certain that DC power of the proper polarity is applied; when replacing DC plugs, check to be sure that the plug is wired correctly, as there is little standardization in the world for the power plug used for the FT-690R. Failure to observe these simple precautions will void any and all warranties on this equipment.

(7) CHG

The external charge jack accepts charging voltage from the NC-11B/C battery charger (Option). When using alkaline or other dry cell batteries, do not attempt to recharge them. Use only C size Ni-Cd cells (available from your Yaesu dealer) if you desire rechargeable cells.

(8) ANT

This is a UHF type connector for use with an external antenna of 50 ohms impedance (nominal). When using an external antenna, the internal whip should be telescoped fully inside the radio.

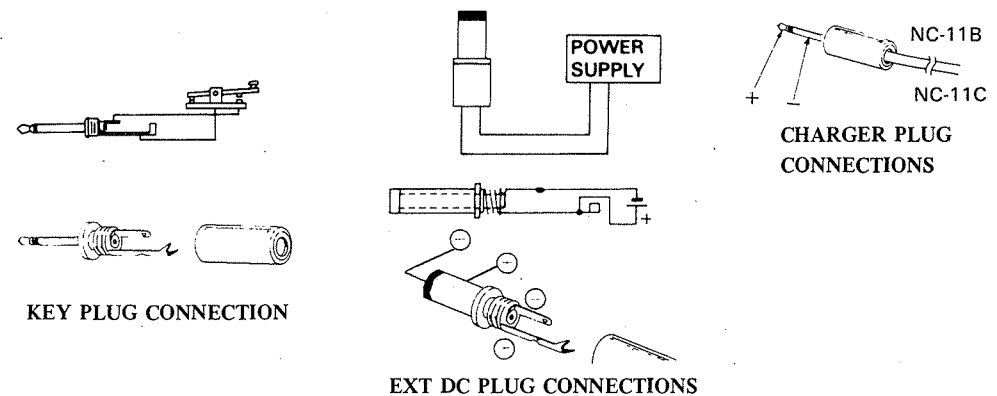

SIDE PANEL JACKS

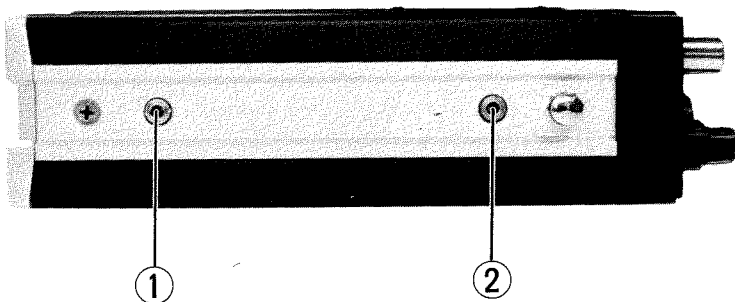

(1) STAND BY

This jack is wired in parallel with the PTT line of the microphone, thus allowing the use of a footswitch to activate the transmitter.

(2) EXT SP

Use this jack for connection to an external speaker. The output impedance is 8 ohms.

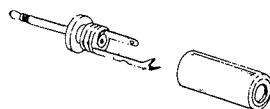
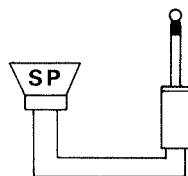
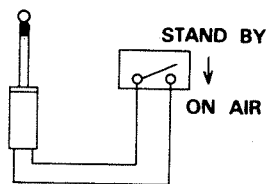

C2111, 3041, 3058, 3059, 3061	K13170103	Ceramic Disc (DB201YF103Z5L5)	50WV	0.01 μ F
C3062, 3063	K13170223	" " (DD109F223Z50V02)	"	0.022 μ F
C1024, 1031, 1098, 1099, 1133, 2008, 2041	K19149001	" " (UTA04X102K-L05AE)	25WV	0.001 μ F
C1124	K19149005	" " (UAT04X222K-L05AE)	"	0.0022 μ F
C2009	K19149007	" " (UAT05X332K-L05AE)	"	0.0033 μ F
C1049, 1054, 1060, 1063, 1065, 1068, 1069, 1071, 1108, 1125, 1139, 2008, 2010, 2012, 2017, 2043	K19149013	" " (UAT05X103K-L05AE)	"	0.01 μ F
C1100, 1102, 1117, 2016	K19149017	" " (UAT06X223K-L45AE)	"	0.022 μ F
C1021, 1025, 1027, 1028, 1030, 1034, 1035, 1037, 1039, 1043, 1045, 1047, 1050, 1052, 1055, 1057, 1085, 1105, 1106, 1109, 1110, 1115, 1121, 1138, 2024, 2025, 2044, 2045, 3003, *1141	K19149021	" " (UAT08X473K-L45AE)	"	0.047 μ F
C1091, 1135	K19149025	" " (UAT13X104K-L46AE)	"	0.1 μ F
C1097	K40179002	Electrolytic (50RC2-R1)	50WV	0.1 μ F
C1042, 1059, 1062, 1067, 1086, 1111, 1112, 1118, 1126, 1129, 2001, 2005, 2006, 2013, 2026, 3027	K40179001	" " (50RC2-1)	"	1 μ F

C2031, 2032, 3038, 3039	K06175101	Ceramic Disc (DD106UJ101J50V02)	50WV UJ	100pF
C1096	K00175121	" " (DD105SL121J50V02)	" SL	120pF
C3035	K06175181	" " (ECC-D1H181JU2)	" UJ	180pF
C1075	K02179025	" " (DD111CH221J50V02)	" CH	220pF
C2113	K00175221	" " (DD107SL221J50V02)	" SL	220pF
C1041	K00175331	" " (DD107SL331J50V02)	" "	330pF
C1006, 1008, 1048, 1066, 1130, 2002, 2003, 2018, 2058, 2059, 2062, 2063, 2108, 3016, 3052	K12171102	" " (DD105E102P50V02)	" "	0.001 μ F
C1001, 1002, 1004, 1024, 2015, 2035, 2039, 2040, 2046, 2060, 2061, 2068, 2069, 2079– 2081, 2084, 2085, 2091– 2094, 2097, 2100, 2102, 2105, 2107, 3009, 3011– 3013, 3015, 3018, 3020, 3023, 3026, 3028–3030, 3037, 3042, 3044, 3049– 3051, 3055	K14179002	" " (RD204YM103Z50V)	" "	0.01 μ F
C1005, 1007, 1011, 1018, 1061, 1073, 1074, 1080, 1082, 1084, 1088–1090, 1119, 1120, 2033, 2054	K13170103	" " (DB201YF103Z5L5)	" "	0.01 μ F

INTERNAL SWITCHES

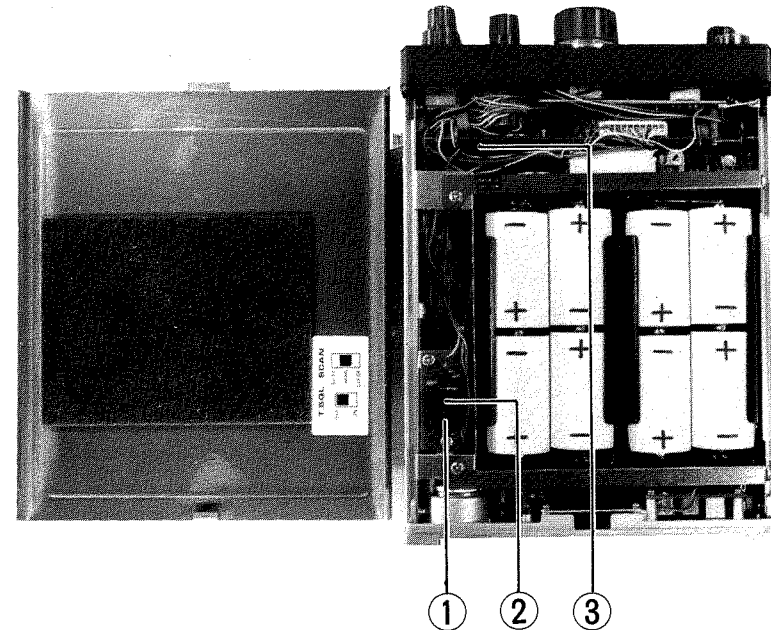

(1) TSQL

When the optional tone squelch unit is installed, this switch will place the unit in operation.

(2) SCAN

This switch selects scanning stop on a busy or clear channel, per your requirements. Manual scanning can also be selected, if desired.

(3) BACKUP

This switch activates the memory backup feature. Once the batteries are correctly installed, this switch may be turned on and left on indefinitely. See the operation section for details.

LOCK ← OPEN

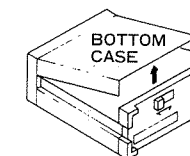

ANTENNA CONSIDERATIONS

The FT-690R is designed for use into a 50 ohm resistive load. While departures from this value are of no significant consequence, it is possible to damage the transmitter circuitry if no antenna is connected and the transmitter is activated.

For most portable use, the built-in telescoping whip antenna will provide satisfactory operation. For base station use, any of the popular beam or phased arrays will provide excellent performance, so long as they present the proper impedance to the transmitter and have been optimized for best forward gain.

When an external antenna is being used, the whip antenna should be telescoped fully into the FT-690R. Conversely, when no external antenna is connected, the whip should be fully extended. Failure to observe these simple precautions will void all warranties on this unit.

BATTERY INFORMATION

The FT-690R is designed for use with eight size C Ni-Cd rechargeable cells or eight dry cells of the same size. When using alkaline cells or other dry cell types, no "dummy" battery is required, as the FT-690R will tolerate the slightly elevated voltage of these batteries as compared to Ni-Cd cells.

To install batteries, set the rear panel lever to OPEN to unlock the case. The cabinet may then be carefully removed, exposing the battery holder. Install the eight new cells, being absolutely certain to observe the proper polarity.

WARNING

Serious damage can occur if incorrect battery polarity is used. Our warranty does not cover damage caused by incorrect polarity in the battery compartment.

C1058	K00172050	Ceramic Disc (DD104SL050C50V02)	50WV SL	5pF
C2070, 3006	K02173060	" " (DD104CH060D50V02)	" CH	6pF
C1023, 2038, 3022	K00173060	" " (DD104SL060D50V02)	" SL	6pF
C1046, 2101	K00173070	" " (DD104SL070D50V02)	" "	7pF
C1101, 1120, 3043, 3047	K00173100	" " (DD104SL100D50V02)	" "	.10pF
C3002, 3005	K02173100	" " (DD104CH100D50V02)	" CH	10pF
C3053	K06175150	" " (ECC-D1H150JU)	" UJ	15pF
C1078	K02175180	" " (DD104CH180J50V02)	" "	18pF
C2056, 2057, 2067	K00175220	" " (DD104SL220J50V02)	" SL	22pF
C3001, 3007	K02179009	" " (DD104CH220J50V02)	" CH	22pF
C1003, 1009, 1014, 1016, 2071, 2082	K06175220	" " (ECC-D1H220JU)	" UJ	22pF
	K06175270	" " (ECC-D1H270JU)	" UJ	27pF
C1012	K00175270	" " (DD104SL270J50V02)	" SL	27pF
C1040, 2078, 3031, 3032, 3040	K00175330	" " (DD104SL330J50V02)	" "	33pF
C1079	K02175330	" " (DD104CH330J50V02)	" CH	33pF
C1072, 1095, 1116, 2099	K00175470	" " (DD104SL470J50V02)	" SL	47pF
C2027	K05175470	" " (RD871-1N220470J63)	" RH	47pF
C2064, 2065	K06175470	" " (ECC-D1H470JU2)	" UJ	47pF
	K06179009	" " (DD105UJ560J50V02)	" "	56pF
C2103, 3024, 3025	K00175560	" " (DD104SL560J50V02)	" SL	56pF
C2104, 2106	K00175820	" " (DD104SL820J50V02)	" "	82pF
C1053, 1083, 1113, 2087, 2112	K00175101	" " (DD105SL101J50V02)	" "	100pF
C1076	K02175101	" " (DD107CH101J50V02)	" CH	100pF
C1127, 2089	K00179056	" " (ECC-D1H101J2)	" SL	100pF

R1020, 1027, 1108, 1120, 2034	J00215474	Carbon Film	1/8W	VJ	470k Ω
R2006, 2040	J00215684	" "	" "	" "	680k Ω
R1092	J00215824	" "	" "	" "	820k Ω
R1004, 3025	J00215105	" "	" "	" "	1M Ω
R1123	J01215105	" "	" "	TJ	1M Ω
R1066, 1097	J00215155	" "	" "	VJ	1.5M Ω
R2002	J00215225	" "	" "	" "	2.2M Ω
R1067	J00215335	" "	" "	" "	3.3M Ω
		POTENTIOMETER			
VR2002, 2007	J51745102	H0651A-1KB	1k Ω B		
VR2003, 2004	J51745103	H0651A-10KB	10k Ω B		
VR1002, 2001	J51745223	H0651A-22KB	22k Ω B		
VR1001, 3002	J51745473	H0651A-47KB	47k Ω B		
VR2005, 2006	J51745104	H0651A-100KB	100k Ω B		
VR3001	J51745154	H0651A-150KB	150k Ω B		
VR1003	J51745225	H0651A-2.2MB	2.2M Ω B		
		THERMISTOR			
TH3001	G9090008	31D26			
		CAPACITOR			
C3046	K00172010	Ceramic Disc	50WV	SL	1pF
		(DD104SL010C50V02)			
C1015, 3021, *1140	K00172020	" "	" "	" "	2pF
		(DD104SL020C50V02)			
C3014	K02179003	" "	" "	CH	2pF
		(DD104CK020C50V02)			
C2030	K06172030	" "	" "	UJ	3pF
		(ECC-D1H030CU)			
C3008	K02179004	" "	" "	CH	3pF
		(DD104CH030C50V02)			
C3017	K00172030	" "	" "	SL	3pF
		(DD104SL030C50V02)			
C*1093	K00172040	" "	" "	" "	4pF
		(DD104SL040C50V02)			
C3004	K06172040	" "	" "	UJ	4pF
		(ECC-D1H040CU)			
C1010, 1013, 1017, 1026, 2066, 2070	K02172040	" "	" "	CH	4pF
		(DD104CH040C50V02)			
C2083	K02172050	" "	" "	" "	5pF
		(DD104CH050C50V02)			
C3060	K06173060	" "	" "	UJ	6pF
		(ECC-D1H060DU)			

If Ni-Cd cells are used, the optional NC-11B/C battery charger may be used to return the cells to a full charge. Always be certain that cells are allowed to discharge fully before recharging them. If the cells are only partially exhausted, and repeatedly recharged in this condition, they may develop a memory for this level, and not provide full discharge capability.

Ni-Cd cells suitable for use in the FT-690R are available from your Yaesu dealer. Ask also for the MMB-11 Mobile Mounting Bracket and CSC-1 vinyl carrying case for the FT-690R.

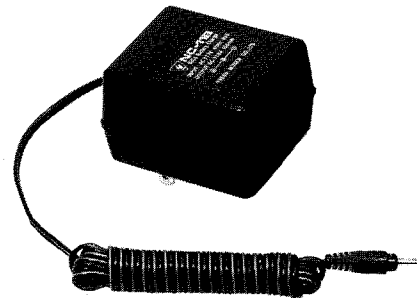

NC-11B (117V AC)

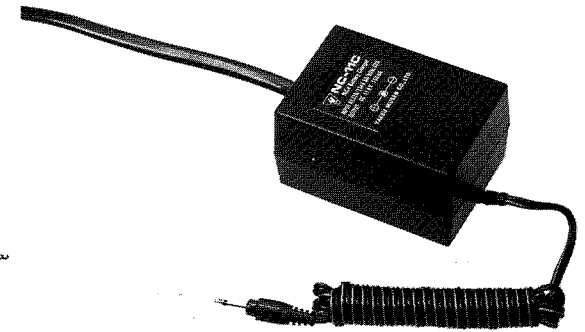

NC-11C (220 - 234V AC)

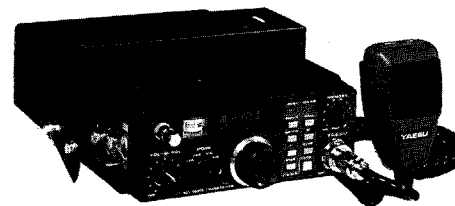

FT-690R/MMB-11/YM-47

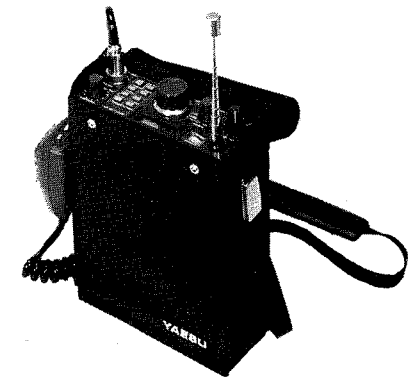

FT-690R/CSC-1/YM-47

OPERATION

The tuning procedure for this transceiver is not complicated. However, because microcomputer circuitry is used extensively throughout the transceiver, this section should be read thoroughly, so as to understand all of the features that are made available. Note that off-frequency operation could occur without proper setting of the controls, because of the many options the operator has for frequency selection.

INITIAL CHECK

Before operating the transceiver, be certain that the necessary batteries are installed in the case, as described previously. Extend fully the built-in telescoping whip antenna, if used. If an external antenna is used, be certain that the internal whip antenna is fully nested into the FT-690R. If an external voltage source is used instead of batteries, confirm that the proper DC voltage is being applied to the rear panel jack, and that the proper polarity is used.

FREQUENCY READOUT

Frequency display is provided by way of a five-digit Liquid Crystal Display (LCD) system. Resolution of the last five digits of the operating frequency is provided to 0.1 kHz.

When operating on a memory channel, the letter "M" will appear on the left side of the display. The memory channel number will not be shown, as it is already shown on the selector switch labeling. The actual memorized frequency will be displayed, however.

R1011, 1025, 1029, 1068, 1071, 1089, 1100, 1104, 1105, 1109, 2015-2017, 2042, 2044, 2045, 2060, 2073, 2075, 3016, *2080	J00215103	Carbon Film	1/8W	VJ	10k Ω
R2010	J00215123	" "	" "	" "	12k Ω
R1080, 1082	J00215153	" "	" "	" "	15k Ω
R1010, 1063, 1069, 1098, 2011, 2021, 2026, 2031, 2036, 2084, 3004, 3005, 3015, 3033, 3037, *1127	J00215223	" "	" "	" "	22k Ω
R1114, 1115, 2029, 2031, 2038	J10246223	" Composition	1/4W	GK	22k Ω
R3026	J10246333	" "	" "	" "	33k Ω
R1129	J01215333	Film	1/8W	TJ	33k Ω
R2022, 2043	J00215333	" "	" "	VJ	33k Ω
R1016, 1035, 1039, 1064, 1084, 1085, 1090, 1110, 2025, 2030, 2032, 2050, 2051, 3001, 3034, 3038, *2079	J00215473	" "	" "	" "	47k Ω
R1075	J10276473	" Composition	1/4W	GK	47k Ω
R1050	J00215563	" Film	1/8W	VJ	56k Ω
R1094	J00215683	" "	" "	" "	68k Ω
R1073	J00215823	" "	" "	" "	82k Ω
R1074	J10276823	" Composition	1/4W	GK	82k Ω
R1003, 1006, 1008, 1009, 1099, 2023, 2052, 2053, 2055, 2057, 2062, 3006, 3032, 3044, *2081	J00215104	" Film	1/8W	VJ	100k Ω
R3022-3024	J10246104	" Composition	1/4W	GK	100k Ω
R1112	J00215124	" Film	1/8W	VJ	120k Ω
R1024, 1111, 3021	J00215154	" "	" "	" "	150k Ω
R1119	J00215224	" "	" "	" "	220k Ω
R1079, 3043	J00215274	" "	" "	" "	270k Ω
R3042	J00215334	" "	" "	" "	330k Ω
R2033	J00215394	" "	" "	" "	390k Ω

R2077	J10246221	Carbon Composition	1/4W	GK	220Ω
R1116, 2028, 3002, 3007	J00215221	" Film	1/8W	VJ	220Ω
R2072	J02245331	" "	1/4W	SJ	330Ω
R1128, 2070	J01215331	" "	1/8W	TJ	330Ω
R2068	J00215391	" "	"	VJ	390Ω
R2013, 2014, 2027, 2061, 3036, 3039	J00215471	" "	"	"	470Ω
R1032, 1054, 1055	J00215561	" "	"	"	560Ω
R1065	J10246561	" Composition	1/4W	GK	560Ω
R2085	J01215681	" Film	1/8W	TJ	680Ω
R3013	J00215821	" "	"	VJ	820Ω
R1033, 1034, 1036, 1044, 1049, 1077, 1101, 1107, 1124, 2003, 2019, 3018, 3027, 3031, 3035, *1126	J00215102	" "	"	"	1kΩ
R1040, 2007	J10246102	" Composition	1/4W	GK	1kΩ
R3048	J00215122	" Film	1/8W	VJ	1.2kΩ
R1076	J10246152	" Composition	1/4W	GK	1.5kΩ
R1081, 1087, 2018, 3017, 3030	J00215152	" Film	1/8W	VJ	1.5kΩ
R1019, 1031, 1058, 1083, 1088, 1091, 1095, 1118, 2008, 2012, 3028, 3029	J00215222	" "	"	"	2.2kΩ
R1042, 3009– 3011	J00215272	" "	"	"	2.7kΩ
R3020	J10246272	" Composition	1/4W	GK	2.7kΩ
R1046, 1056, 1062, 1102, 2001, 2039	J00215332	" Film	1/8W	VJ	3.3kΩ
R1053, 2082	J00215392	" "	"	"	3.9kΩ
R1051, 1061, 1070, 1072, 1086, 1096, 1106, 2004, 2009, 2049, *1125	J00215472	" "	"	"	4.7kΩ
R1078	J10246472	" Composition	1/4W	GK	4.7kΩ
R1103	J00215562	" Film	1/8W	VJ	5.6kΩ
R1013	J00215682	" "	"	"	6.8kΩ
R1050, 2005	J00215822	" "	"	"	8.2kΩ
R1001, 2037, 3041, 3045	J10246103	" Composition	1/4W	GK	10kΩ

SSB/AM OPERATION

Preset the controls and switches as follows:

VOL	OFF (Fully counterclockwise)
SQL	Fully counterclockwise
MODE	Desired mode, SSB (USB) or AM
MEMORY	Channel 1
LAMP (Rear apron)	OFF
NB (" ")	OFF
HI/LOW (" ")	HI

Rotate the VOL switch out of the click-stop, and adjust the volume level for a comfortable audio output from the speaker. The LCD display will indicate the operating frequency. Initially (first switch-on after the memory backup battery has been installed), the display will indicate "0.000.0" (50.000.0 MHz) as a preset frequency; thereafter, when the transceiver is switched on, the backup feature will keep you locked onto the frequency and mode (dial or memory) last used when you switched the unit off.

The STEP switch is used to select the desired synthesizer step, 1 kHz or 100 Hz per step (SSB/CW/AM modes). If you rotate the main tuning dial, initially the synthesizer will provide 1 kHz steps. Press the STEP button once, and you will note that the steps are now 100 Hz (0.1 kHz) each. Another pressing of the STEP button will return the selection to 1 kHz/step.

Rotate the main tuning dial until an SSB signal is heard. Using the 100 Hz/step mode, tune in the signal until a natural reproduction of the voice signal is obtained.

To transmit, close the microphone PTT switch, and speak at a normal level into the microphone. Release the PTT switch for receiver recovery. The microphone amplifier gain is preset in this transceiver, and it requires no further adjustment for normal operation.

If the station you are in contact with suddenly begins to drift, you may follow the drifting station by activating the receiver offset tuning control (CLARIFIER). Push the CLAR button, and then rotate the main tuning dial (or push the scanning controls) until the desired frequency is reached. In the CLAR mode, the synthesizer is automatically set to the 100 Hz step mode, and the STEP button is disabled. The clarifier leaves the transmit frequency unchanged.

Push the CLAR button again to return to normal operation with the clarifier off. If you switch the clarifier on again, the receiver will not return to the last offset frequency, but rather will initiate on the current operating frequency.

If pulse-type noise is encountered, the rear apron NB (Noise Blanker) switch may be activated. While no noise blanker can be expected to eliminate all types of atmospheric and man-made noise encountered in day-to-day operation, the FT-690R noise blanker should be quite helpful in reducing interference caused by pulse noise such as that produced by automobile ignition systems.

To reduce power for local communication, place the HI/LOW power switch in the LOW position. In this position, the PEP output power is approximately 500 mW (AM: 200 mW). Battery consumption will be greatly reduced by using the low power position whenever possible.

D2011-2013, 2016, 2017, 2023, 2026, 2028, 2029, 3002-3004	G2090027	Si	1SS53
D2024, 2025	G2090033	Si	MI301
D3007	G2090196	Zener	HZ6C-1L
D2030	G2090193	"	RD5.6EB-3
		CRYSTAL	
X1002	H0100992	HC-18/U	10.8115 MHz
X1003	H0101100A	HC-18/U	11.265 MHz
X2001	H0101020	HC-18/U	10.810 MHz
X3001	H0102434	HC-18/T	5.76 MHz
X3002	H0102400	HC-18/T	17.6183 MHz
		CRYSTAL FILTER	
XF1001	H1102021	108M 30B	
XF1002	H1102022	10F2D	10.81 MHz
		CERAMIC FILTER	
CF1001	H3900171	CFG455E-1/SLFD15SA	
CF1002	H3900020	LFB-4	
		RESISTOR	
R1122	J10246229	Carbon Composition	1/4W GK 2.2Ω
R2083	J10246479	" "	" " 4.7Ω
R2069	J00215220	" Film	1/8W VJ 22Ω
R2071	J00215470	" "	" " 47Ω
R1018, 1038, 1121, 2020, 2063	J00215560	" "	" " 56Ω
R2059	J10246390	" Composition	1/4W GK 39Ω
R1012, 1021, 1023, 1026, 1030, 1043, 1048, 1052, 1057, 1093, 2054, 2067, 3003, 3008, 3012, 3019, 3040, *2078	J00215101	" Film	1/8W VJ 100Ω
	J01215101	" "	" TJ 100Ω
R1113, 3047	J10246101	" Composition	1/4W GK 100Ω
R1005, 1015, 1037, 1041	J00215151	" Film	1/8W VJ 150Ω

Q1009, 1015, 3001	G3801920G	2SK192 GR
Q3007	G3800301Y	2SK30A-Y
Q2017, 2018	G3801930F	2SK193-F
		TRANSISTOR
Q1004, 3004, 3005, 3009, 3010	G3305350A	2SC535A
Q1007, 1013, 1014, 1017, 1020-1026, 2001-2003, 2006-2009, *2023	G3326030E	2SC2603E
Q1008	G3090005	MPS-A13
Q1016	G3107331Q	2SA733Q
Q1018	G3107331P	2SA733P
Q1005	G3315830	2SC1583
Q1006, 2005, *1028	G3327860L	2SC2786L
Q2011, 3008	G3309450P	2SC945P
Q2012	G3309451P	2SC945AP
Q2021	G3320530	2SC2053
Q2022	G3319470	2SC1947
		DIODE
D3006	G2090023	Varactor 1SV50
D2005	G2090108	" 1SV68
D1001-1004, 2018, 2019, 2022, 3008	G2090109	" 1SV69
D3001	G2090107	" 1T25
	G9090005	Varistor MV-103
D1005, 1006, 1028, 1029, 1031, 1035, 1040, 1041, 1044, 2007- 2010, 2027, 3005	G2001880F	Ge 1S188FM
D2023	G2015550	Si 1S1555
D1007-1012, 1014-1018, 1020-1022, 1030, 1032- 1034, 1036- 1039, 1043, 1045, 1046, 2001-2004, 2027	G2090027	" 1SS53

FM OPERATION

Preset the controls and switches as described for SSB operation, but set the MODE switch to FM/SIMP.

In the FM mode, the synthesizer steps provided are 10 kHz and 20 kHz per step (the clarifier steps are still 100 Hz/step). When you are changing modes from SSB to FM, and were last operating on other than a 10 kHz or 20 kHz step, the microprocessor will automatically move you to the next higher or lower 10 kHz or 20 kHz step upon the first click of the main tuning dial (or first stepping of the scanner).

Rotate the main tuning dial (or operate the scanning controls) until the desired frequency is reached. To transmit, close the PTT switch, and speak into the microphone in a normal voice. Release the PTT switch for receiver recovery.

For repeater operation, selection of the standard ± 1 MHz splits is provided on the front panel. For -1 MHz shift, set the MODE switch to FM/-, and for $+1$ MHz shift, select FM/+. This selection can be made either during main dial or memory operation.

For operation on odd splits, use a combination of the memory system and the main tuning dial. First, store the desired receive frequency in any memory channel. Now use the main dial to select the desired transmit frequency. Next push the yellow F and S buttons. You will now be receiving on the memory channel just programmed. When you close the PTT switch, you will be transmitting on the main dial frequency. If you desire to listen on several memory channels, the memory channel selector may be rotated as desired.

The front panel CALL switch activates a manual-length 1800 Hz tone for repeater access. When this button is pushed, the transmitter is activated and the access tone is superimposed on the transmit signal.

Rotate the SQL (Squelch) control fully counterclockwise. Now turn the VOL control out of the click-stop to turn the transceiver on. Advance the volume control for a comfortable listening level.

When the channel is clear, adjust the SQL control so the background noise just disappears. This threshold point is the point of maximum sensitivity, and the squelch control should not be advanced beyond this point too far, or the squelch will not respond to weak signals.

CW OPERATION

- (1) The synthesizer steps selected in the CW mode are identical to those used for SSB operation.
- (2) Connect a key to the rear panel KEY jack, using a miniature phone plug. The key-up voltage is 7V, while the key-down current is 0.3mA, so most electronic keyers that close completely to ground will work well with the FT-690R.
- (3) Set the MODE switch to CW.
- (4) Close the PTT switch on the microphone to switch to the transmit mode. If desired, a footswitch may be used with the FT-690R. The STAND BY jack, located on the side of the transceiver, is wired in parallel with the PTT line on the microphone. This may be used in situations where the microphone is not the most efficient means of activating the transmitter.
- (5) The clarifier may be used for following unstable signals. The clarifier allows offset tuning in 100 Hz steps away from the transmit frequency. See the section on clarifier operation for details.

SPEAKER		
SP01	M4090029A	SM-50A 8Ω
CONNECTOR		
P01 (with wire)	T9204140	XHP-9
P02 (with wire)	T9204150	XHP-10
P03 (with wire)	T9204160	XHP-12
P04 (with wire)	T9204247	XHP-13
P05 (with wire)	T9204248A	3021-05
METER		
M01	M0290023	T-22
ANTENNA		
ANT01	Q3000021	
BATTERY HOLDER		
	Q9000116B	C-12A (with wire)
	Q9000117B	C-12A (with wire)
MAIN UNIT		
Symbol No.	Part No.	Description
PB-2235B	F0002235B	Printed Circuit Board
	C0022350	P.C.B. with Components
PB-2304	F0002304	Printed Circuit Board
	C0023040	P.C.B. with Components (*)
PB-2304	F0002304	Printed Circuit Board
	C0023041	P.C.B. with Components (★)
IC		
Q1012	P1090340	MC1496P
Q1019	G1090145	MC3357 P
Q1027	G1090073	μPC575-C2
Q2004	G1090072	μPC577-H
Q2010	G1090027	MC14001B
Q3006	G1090237	μPD2819 C
FET		
Q1001	G4800590Y	3SK59Y
Q1002	G4800510C	3SK51
Q1003, 1010, 1011, 3002	G4800730Y	3SK73-Y

PARTS LIST

MAIN CHASSIS		
Symbol No.	Part No.	Description
		DIODE
D03	G2090027	Si 1SS53
D02	G2090001	Si 10D-1
D01, 04	G2090034	Si U05B
		RESISTOR
R02	J01215101	Carbon Film 1/8W TJ 100Ω
		POTENTIOMETER
VR01 (with S01)	J62800057	K12B61004-5N1211-5KB, 10KB
		CAPACITOR
C08	K00172020	Ceramic Disc 50WV SL 2pF (DD104SL020C50V02)
C03	K00175560	" " " " 56pF (DD104SL560J50V02)
C01, 02, 05-07	K14179002	" " " " 0.01μF (RD204YM103Z50V)
		INDUCTOR
L01, 02, 03	L0020979 L0021085	
		SWITCH
S01 (with VR01)	-	
S02	Q9000115	EWT-XDBS2050B
S03	N0190082	SRN 3066
S04	N0190084	SRS 101C SWITCH UNIT (C)
PB-2240	F0002240 C0022400	Printed Circuit Board P.C.B. with S04
S05	N6090028	SSH-P-23-05 SWITCH UNIT (A)
S06, 07	N6090029	SSFYP-22-07 SWITCH UNIT (A)
PB-2242	F0002242 C0022420	Printed Circuit Board P.C.B. with S05, S06, S07
		RECEPTACLE
J01	P0090243	FM214-7SS(A)
J02	P1090193	FM-MR-M
J03, 07	P1090005	S-G8050
J04	P1090051	SG-8512
J05	P0090190	HEC0630
J06	P1090197	SG-8021

CLARIFIER OPERATION

Offset tuning is provided on receive, for tracking of unstable or Doppler-shifted signals. The clarifier may be used either on VFO frequencies or memory frequencies.

To activate the clarifier, push the CLAR button once. The letters "CLAR" will appear on the digital display. Now, tune the receiver as needed to follow the unstable signal. The synthesizer automatically programs 100 Hz steps for clarifier operation. A frequency shift of up to 10 kHz can be accomplished by using the clarifier.

When you close the PTT switch, the digital display will revert to the frequency programmed **before** the clarifier was switched on. In other words, your transmit frequency has remained unchanged, while your receive frequency has been varied.

A second press of the CLAR button will cancel clarifier operation. If the CLAR button is then pressed again, switching the clarifier back on, the clarifier is zeroed to the original operating frequency (before any offset), **not** to the offset frequency programmed previously.

THE UP/DWN CONTROLS ON THE MICROPHONE MAY BE USED FOR SCANNING DURING CLARIFIER OPERATION.

VFO SELECTION

Two VFOs are available on the FT-690R for split frequency operation. The VFO selector button is the largest of the eight mode selector buttons on the front panel of the FT-690R. This switch is a push-push type, not the momentary type used for the other mode selector buttons.

For VFO B operation, push the VFO button once; the switch will hold inward, and the desired frequency may then be dialed up. Be certain, of course, that you are in the DIAL mode. To return to VFO A, simply push the VFO button again to release the switch.

It is not possible to receive on one VFO while transmitting on another. For frequency splits of 10 kHz or less, use the clarifier to achieve this function. Otherwise, use the MEMORY SPLIT mode described elsewhere in this manual.

NOTE REGARDING BACKUP OPERATION

When a backup battery or main batteries are first installed in the FT-690R (after service or replacement), it is necessary to reset the microcomputer properly. Failure to follow a simple sequence of steps may cause erratic operation.

- (1) Set both the VOL and memory backup switches (memory backup switch is located inside the cabinet, as shown on page 11) to OFF.
- (2) Replace the memory backup battery and main batteries (if removed).
- (3) Turn the VOL control out of the click-stop, turning the transceiver ON.
- (4) Now turn the backup switch to ON. The CPU is now reset, and the backup switch may be left on indefinitely, owing to the very low current drain in the backup mode.

- (b) Set the MODE switch to FM and close the PTT switch. Adjust VR₂₀₀₇ so that a minimum spurious level appears ± 10.81 MHz from the carrier on the spectrum analyzer.

12. Battery Check

- (a) Apply DC 9V to the EXT DC 13.8V terminal from an external power supply.
- (b) Set the LAMP/BATT CHECK switch (on the REAR PANEL) to the BATT CHECK position.
- (c) Adjust VR₄₀₀₁ so that the PO meter deflects to the left side of the green zone.

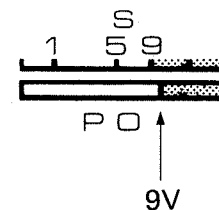
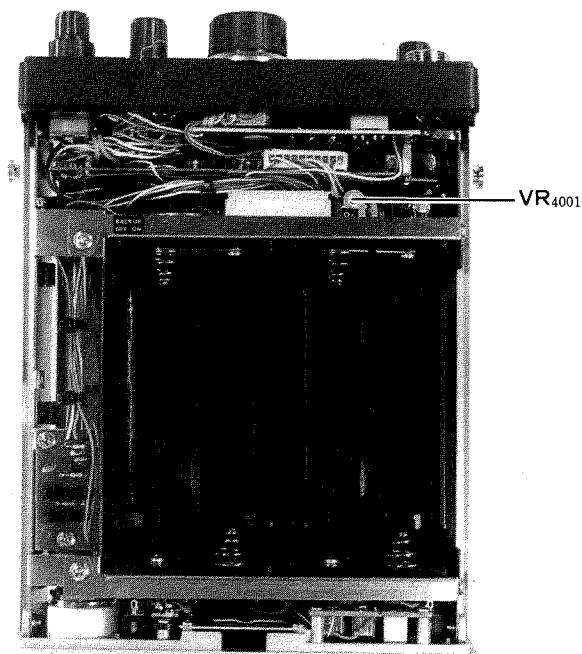

8. SSB Carrier Point Adjustment

- (a) Apply a 1 kHz 2 mV signal from the audio generator to the MIC jack and adjust VR₂₀₀₁ for an output of 2.5 watts.
- (b) Set the MODE switch to SSB and the frequency of the audio generator to 300 Hz. Adjust TC₁₀₀₂ for an output of 0.6 watts.

9. Carrier Balance Adjustment

- (a) Temporarily short the PTT line at the MIC jack, using a jumper wire, not the microphone.
- (b) Monitor the carrier on a monitor receiver, and adjust VR₁₀₀₁ for minimum S-meter reading (or minimum signal level if no S-meter reading occurs).

10. CW Carrier Frequency Adjustment

- (a) Set the MODE switch to CW.
- (b) Connect a frequency counter to the cathode of D₂₀₁₇.
- (c) Connect a CW key to the KEY jack, and then close the PTT switch and KEY simultaneously. Adjust TC₁₀₀₃ for a frequency of exactly 10.8107 MHz.
- (d) Now set the frequency to 52.100.1 MHz and place the input lead from the counter to the dummy load to read the transmit frequency. Then adjust L₃₀₀₇ for a reading of 52.100.0 MHz \pm 100 Hz on the frequency counter.

11. TX Balanced Mixer Alignment

If you do not have a spectrum analyzer, do not perform this alignment, as serious spurious radiation will result.

- (a) Connect a directional coupler between the transceiver and dummy load/wattmeter, and feed the coupled output from the directional coupler to the spectrum analyzer.

MEMORY OPERATION

Ten memory channels are available for storage and recall of favorite operating frequencies. The procedure for entry and recall of memory channels is extremely simple.

Push the DIAL switch for normal tuning, using the main tuning dial. When you have found a frequency you wish to store in memory (for example 50.520 MHz), rotate the MEMORY switch to 1 (channel 1) and push the M (memory store) button. If you wish to store 50.490 MHz in channel 2, rotate the main dial to that frequency, rotate the MEMORY switch to channel 2, and push M, and so forth. This procedure may be repeated for all 10 memory channels.

To recall these frequencies, push the MR button (memory recall) and rotate the MEMORY switch to select the desired channel. One push of the M button will keep you on memory recall operation until the DIAL button is pushed again to return you to main dial tuning. Note that there is no formal erasure procedure for memory channels. When you push the M button, the previous frequency stored in that position will be erased. Until a frequency is programmed into a memory channel (from initial switch on of the transceiver), 50.000 MHz will be preset in all memory channels.

SCANNER OPERATION

The UP/DOWN scanning controls on the microphone may be used to control the operating frequency.

When in the DIAL mode, one push of the UP button will cause the frequency to advance upward by one step of the synthesizer (the step size being programmed by the mode switch and the STEP button). If you hold the UP button down for more than 1/2 second, the scanner will become engaged, and you will begin scanning up the band. Push the UP or DN button or the PTT switch to halt the scan.

Scanning toward a lower frequency is achieved by using the same procedure, only using the DN button on the microphone.

To scan only the memory channels, rotate the MEMORY selector to either of the MS (Memory Scan) positions, and press the MR button. Now, when you push and hold the UP or DN button, the scanner will search the memory channels only. Manual halting of the scan is accomplished by pushing the UP, DN, or PTT switches as before.

Inside the case of the radio, the BUSY-MAN-CLEAR switch allows selection of one of three scan halt modes. In the MAN (Manual) position, scanning is halted as discussed above. If the BUSY position is selected (see Page 11), the scanner will search until a busy channel (one occupied by a station strong enough to break the main squelch) is received. The scan will then pause on that frequency for five seconds. If you choose to stay on that frequency, press one of the scan control buttons or the PTT switch. While in the PAUSE mode, the decimal point farthest to the right will blink; when you push a button to halt the resumption of the scan, the blinking will stop.

To scan for a clear channel (one where the squelch does not open), set the BUSY-MAN-CLEAR switch to CLEAR. The scan will halt, and the decimal point will blink, as in the previous section. Press the UP, DN, or PTT switch to cancel the pause/resume feature and hold on the frequency you stopped at.

Memory scan halting follows the same format as main dial scanning.

PRIORITY CHANNEL OPERATION

Priority channel operation uses a combination of the main dial VFO and the memory. It can be used in conjunction to the automatic scan stop feature of the microprocessor, if desired. The steps for priority channel operation are detailed below.

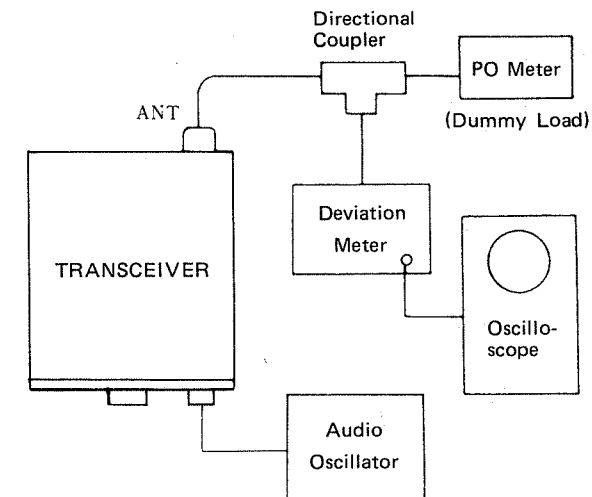

Figure 2

- (c) Now close the PTT switch, and adjust VR₂₀₀₂ for a deviation of ± 4.5 kHz while observing the signal waveform on the scope.
- (d) Reduce the amplitude of the audio generator to 2 mV, and check to see that the linear detector shows ± 3.5 kHz and that the signal waveform on the scope is not distorted.

5. AM Modulator Adjustment

- (a) Set the MODE switch to AM.
- (b) Adjust VR₂₀₀₅ for an output of 0.8 watts without modulation.

6. Low Power Adjustment

- (a) With the dummy load/wattmeter connected to the ANT jack, set the MODE switch to FM and the HI/LOW switch to the LOW position.
- (b) Close the PTT switch and adjust VR₂₀₀₆ for an output of 0.5 watts.

7. SSB Modulator Output Transformer Adjustment

- (a) With a dummy load/wattmeter connected to the ANT jack, set the MODE switch to SSB.
- (b) Set VR₂₀₀₁ to the center of its range and apply a 1 kHz 2 mV signal from the audio generator to the MIC jack.
- (c) Adjust T₁₀₁₂ for maximum power output.

TRANSMITTER

The transmitter alignment should be performed with a dummy load connected to the antenna jack.

1. RF Power Stage Alignment

- (a) Tune the transceiver to 52.000 MHz, and set the MODE switch to FM. Connect a dummy load/wattmeter to the ANT jack.
- (b) Rotate VR₂₀₀₃ and VR₂₀₀₄ fully counterclockwise, and close the PTT switch.
- (c) Connect the RF probe of a VTVM to the cathode of D₃₀₀₃ and check to see that the VTVM shows approximately 500 mV rms.
- (d) Connect the RF probe of the VTVM to the cathode of D₂₀₁₇ and a frequency counter to the same point.
- (e) Adjust the core of L₂₀₀₂ for a reading of 10.81 MHz \pm 100 Hz, and be sure its level is approximately 500 mV rms.
- (f) Now adjust T₂₀₀₁ – T₂₀₀₃, T₂₀₀₅, T₃₀₀₁, TC₂₀₀₄ and TC₂₀₀₅ for maximum reading on the wattmeter.

2. ALC Alignment

- (a) Set the MODE switch to FM, and close the PTT switch.
- (b) Adjust VR₂₀₀₃ for a reading of 2.5 watts on the wattmeter.

3. PO Meter Alignment

- (a) Set the MODE switch to FM and close the PTT switch.
- (b) Adjust VR₂₀₀₄ so that the PO meter indicator reaches the middle of the green zone, with a 2.5 watt reading on the wattmeter.

4. FM Deviation Alignment

- (a) Assemble the test equipment and the transceiver as shown in Figure 2.
- (b) Connect an audio generator to the MIC jack, and apply a 1 kHz 15 mV signal.

- (1) Program into memory the desired priority channel. Do not recall the channel at this time.
- (2) Dial up a basic operating frequency on the main VFO. This will be your main operation channel during priority channel operation.
- (3) Set the BUSY-MAN-CLEAR switch to BUSY or CLEAR, as desired.
- (4) Now push the yellow F button, followed immediately by a press of the MR/PRI button. The letter "P" will appear on the digital display, signifying priority channel operation. The display will then show the VFO frequency, with a flash every five seconds to the memory channel being checked for activity. When the memory channel is busy or clear (depending on your instructions), the scanner will halt on the memory channel. The pause/restart feature does not function in this mode; to restart, simply press the F and MR/PRI buttons again.
- (5) If the scan stop switch is set to the MAN position, the CPU will have no instructions for halting the scan. Simply press the DIAL or MR button to select the desired channel under this mode of operation. If you hit the PTT switch during manual priority channel operation, the checking of the priority channel will be delayed by five seconds.

MEMORY SPLIT OPERATION

The memory split operation mode is useful for covering unusual repeater splits or other occasions where the receive frequency may be fixed, but the transmit frequency is variable. In this mode, you receive on a memory channel, while transmitting on the VFO.

- (1) Store the desired receive frequency into a memory channel.
- (2) Dial up the desired transmit frequency on the main dial.
- (3) Now press the yellow F and DIAL/S buttons. You will be receiving on the memory, while transmitting on the VFO.
- (4) For transmitting purposes, either VFO A or VFO B may be used. Set the VFO selector as needed.

CIRCUIT DESCRIPTION

The block diagram and circuit description to follow will provide you with a better understanding of this transceiver. Please refer to the block and schematic diagrams for specific circuit details.

RECEIVER

The RF signal from the antenna jack is applied to a lowpass filter and diode antenna switch, consisting of D_{2024} and D_{2025} (MI301) and is then fed to an RF amplifier, Q_{1001} (3SK59Y), where the signal is amplified with excellent rejection of cross modulation and intermodulation. The amplified signal is then fed through three sections of Auto-tuning filter to reject unwanted signals which may cause intermodulation at the 1st Mixer, Q_{1002} (3SK51-03). Here, the signal is mixed with a local signal delivered from the local oscillator buffer, resulting in a 10.81 MHz first IF signal.

The first IF signal passes through a pair of monolithic crystal filters, XF_{1001} (108M30B), which have bandwidths of ± 15 kHz. It is then amplified by Q_{1003} (3SK73Y), which acts as a switch, driven by the NB (noise blanker) circuit. The amplified signal from Q_{1003} is fed to IF amplifiers for FM/AM or SSB/CW.

A portion of the RF signal from monolithic crystal filter XF_{1001} is fed to a noise blanker amplifier circuit, consisting of Q_{1004} (2SC535A), Q_{1005} (2SC1583) and Q_{1006} (2SC2786L), where the signal is amplified to a level sufficient to drive the noise blanker rectifier and noise blanker AGC circuits.

When the carrier of a noise-free modulated signal is received, the signal at the noise amplifier is rectified by D_{1005} and D_{1006} (1S188FM), producing a DC voltage. The DC voltage is amplified by Q_{1007} (2SC2603E), which charges C_{1042} for AGC purposes. The AGC voltage is used to control the gain of Q_{1005} and Q_{1006} .

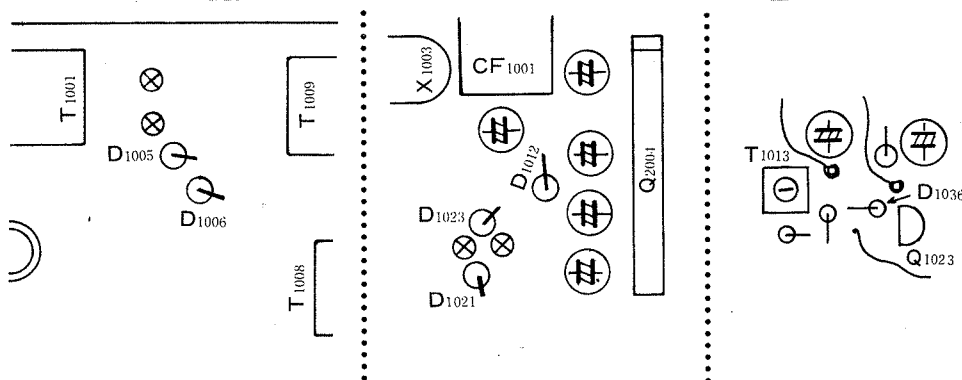
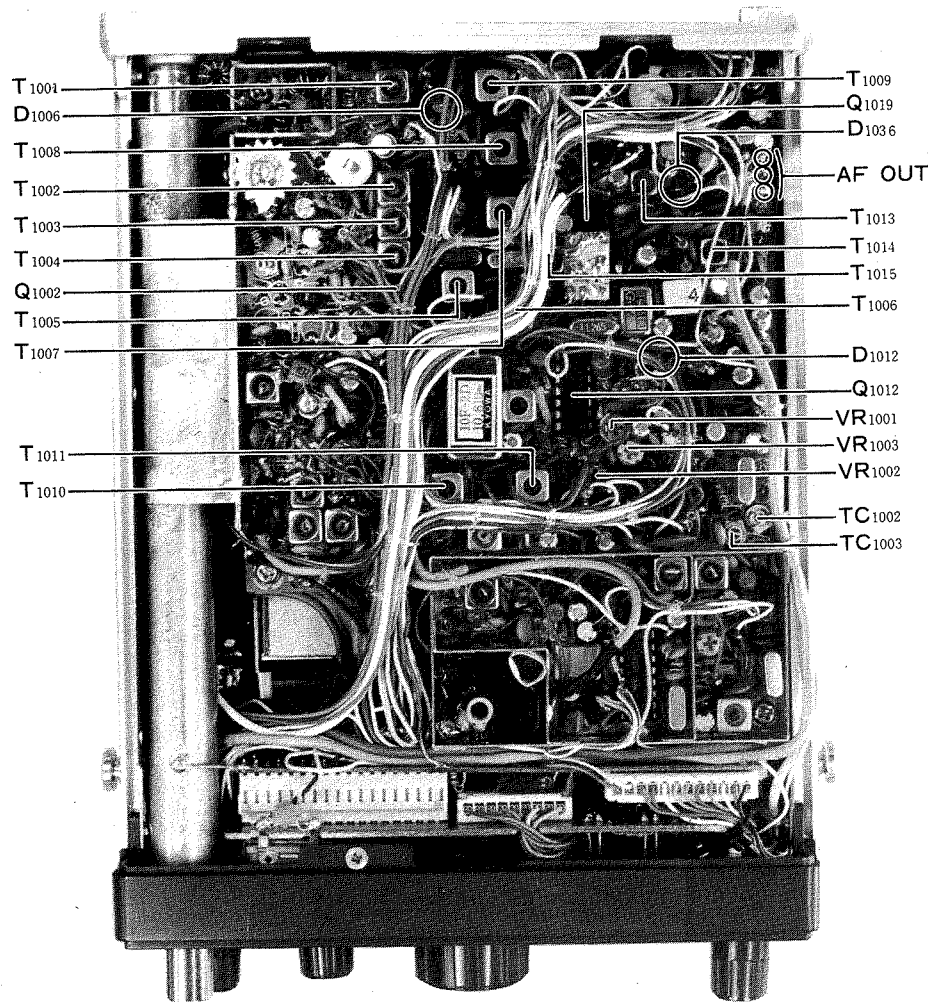

RECEIVER SECTION ALIGNMENT POINTS

When a pulse-type noise is received, D₁₀₀₅ and D₁₀₀₆ rectify the noise, and it is then fed through D₁₀₄₄ (1S188FM) to a DC amplifier, Q₁₀₀₈ (MPSA13), which drives gate 2 of Q₁₀₀₃.

The FM/AM mode signals are fed to mixer Q₁₀₂₈ (2SC2786L), where they are heterodyned with an 11.265 MHz local signal delivered from the oscillator section of Q₁₀₁₉ (MC3357P), resulting in a 455 kHz FM/AM IF signal.

This signal then passes through ceramic filter CF₁₀₀₁ and is amplified by Q₁₀₂₀ (2SC2603E) for the FM and AM IF amplifiers.

The FM mode signal is delivered to the IF amplifier/limiter section of Q₁₀₁₉, where the IF signal is amplified, and any amplitude modulation in the signal is rejected. Then, the signal is delivered to the discriminator section, which produces an audio output in response to a corresponding shift in the 455 kHz IF signal.

When no carrier is present in the 455 kHz IF, the high frequency noise at the discriminator output, which passes through a bandpass filter, is amplified by the noise amplifier in Q₁₀₁₉ and detected by D₁₀₃₂ (1S188FM), producing a DC voltage. This voltage activates a switch in Q₁₀₁₉ which grounds the base of Q₁₀₂₁ (2SC2603E), to turn off the AF output from the discriminator to the AF amplifier.

When a carrier is present in the 455 kHz IF, the noise is removed from the discriminator and the audio amplifier then returns to normal operation. The squelch threshold sensitivity is set by VR_{1b}.

The 455 kHz AM IF signal from Q₁₀₂₀ is fed through a ceramic filter, CF₁₀₀₂ to AM IF amplifier Q₁₀₂₂ (2SC2603E). This amplified signal is then detected by a diode AM detector, D₁₀₃₅ (1S188FM), producing an AF signal. It is then amplified by Q₁₀₂₃ (2SC2603E) for the AF amplifier.

SSB and CW mode IF signals from Q₁₀₀₃ are passed through a crystal filter, XF₁₀₀₂, which has a very high shape factor, to reduce signals on adjacent frequencies. The filtered SSB signal is amplified by Q₁₀₁₀ and Q₁₀₁₁ (3SK73Y), and then fed to the balanced demodulator, Q₁₀₁₂ (MC1496P),

4. AM IF Alignment

- (a) Set the MODE switch to AM and the frequency to 52 MHz.
- (b) Connect an RF signal generator to the ANT jack and set the output level and frequency to 15 dB μ at 52 MHz (1 kHz, 30% modulated).
- (c) Connect an oscilloscope to D₁₀₃₆, and adjust the core of T₁₀₁₄ for maximum amplitude on the scope.

5. RF Coil Alignment

- (a) Set the output level and frequency of the generator to 10 dB μ at 52 MHz.
- (b) Set the receiver frequency to 52 MHz, and adjust the cores of T₁₀₀₁ – T₁₀₀₄ for maximum deflection on the S-meter.

6. S-meter Alignment

- (a) Set the MODE switch to SSB and preset VR₁₀₀₁ to the center position.
- (b) Apply a 16 dB μ signal from the signal generator, and adjust VR₁₀₀₃ for a reading of S9 on the S-meter.
- (c) Now remove the signal from the signal generator, and adjust VR₁₀₀₂ so the S-meter indicates exactly 0.
- (d) Repeat steps (b) and (c) a few times to obtain the proper S-meter deflection.

7. N.B. Alignment

- (a) Set the MODE switch to CW and apply a 5 dB μ signal from the signal generator.
- (b) Connect the \oplus lead of a DC voltmeter to the cathode of D₁₀₀₆ and the \ominus lead to the -6.8 volts line.
- (c) Adjust the cores of T₁₀₀₇ – T₁₀₀₉ for maximum deflection on the voltmeter.
- (d) Next, reduce the amplitude of the signal generator to 0 dB μ , and check the voltmeter, which should show approximately 0.03 volts.

RECEIVER ALIGNMENT

1. First IF Alignment

- Set the MODE switch to FM.
- Connect a sweep generator output to gate 1 of Q_{1002} and set the frequency of the sweep generator to 10.81 MHz.
Connect an oscilloscope, through a detector, to pin 16 of Q_{1019} .
- Adjust the cores of T_{1005} , T_{1006} and T_{1015} until the scope pattern illustrated in Figure 1 is obtained.

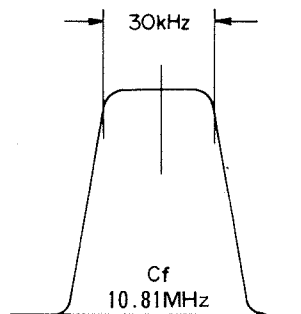

Figure 1

2. FM Discriminator Alignment

- Set the MODE switch to FM and the SQL control fully counterclockwise.
- Connect an audio voltmeter to the speaker terminal.
- Set the VOL control to the center position, and adjust the core of T_{1013} for a maximum reading on the meter.

3. SSB/CW IF Alignment

- Set the MODE switch to CW and the frequency to 52 MHz.
- Connect an RF signal generator to the ANT jack and set the output level and frequency to 15 dB μ at 52 MHz.
- Adjust the cores of T_{1006} , T_{1010} and T_{1011} for maximum reading on the S-meter.

where a carrier signal is applied from carrier oscillator Q_{1013} (2SC2603E), resulting in an AF signal, which is then fed to the AF amplifier.

The AF amplifier consists of Q_{1025} , Q_{1026} (2SC2603E) and Q_{1027} (μ PC575C-2). The AF signal from the FM discriminator and the balanced demodulator are amplified by Q_{1025} , and fed to active lowpass filter Q_{1026} , where the AF signal above 3 kHz is cut off. The AF signal is then delivered to AF power amplifier Q_{1027} , providing approximately 1 watt of audio output to the speaker.

S-METER AND AGC CIRCUITS

A portion of the IF signal from Q_{1011} is rectified by D_{1028} and D_{1029} (1S188FM) and amplified by Q_{1014} (2SC2603E). This amplified DC voltage controls gate 2 of MOS FET's in the IF amplifier. A portion of the AGC signal is buffered by Q_{1015} (2SK192GR), and fed to the S-meter amplifier, Q_{1016} (2SA733Q), providing a DC voltage for the S-meter deflection.

TRANSMITTER

The discussion of the signal flow on transmit will be made on a mode-by-mode basis.

SSB

The audio input signal from the microphone is amplified by Q_{2001} and Q_{2002} (2SC2603E), and then delivered to an active lowpass filter, Q_{2003} (2SC2603E), where the unwanted frequency spectrum above 3 kHz is cut off. This amplified speech signal is fed to balanced modulator Q_{1012} (MC1496P), where the audio signal modulates the 10.8115 MHz carrier signal delivered from the carrier oscillator, Q_{1013} (2SC2603E), resulting in a 10.81 MHz double-sideband signal. The DSB signal is amplified by a buffer, Q_{1009} (2SK192GR), and delivered to crystal filter XF_{1002} (10F2D), where the unwanted sideband is sliced out, resulting in a single sideband signal. This SSB signal is then amplified by Q_{1010} (3SK73Y), and delivered to a mixer, Q_{2017} and Q_{2018} (2SK193F), where the SSB signal is mixed with a local signal from the PLL local oscillator buffer, Q_{3002} (3SK73Y), resulting in a 50 – 54 MHz SSB signal.

The SSB signal passes through an auto-tuning filter consisting of T_{1002} , T_{1003} , T_{1005} and varactor diode D_{1018} , D_{1019} , D_{1021} (1SV69), where the resonant frequency is tuned exactly to the transmitting frequency, thus minimizing spurious radiation. The signal is then amplified by three stages of straight amplifier consisting of Q_{2019} (3SK59GR), Q_{2021} (2SC2053) and Q_{2022} (2SC1947), providing a power output of 2.5 watts over the range of 50 – 54 MHz.

Finally, this signal passes through an RF diode switch and lowpass filter to the ANT connector and built-in telescoping antenna.

FM

The speech signal from the microphone is amplified and limited in amplitude by Q_{2004} (μ PC577H). It is then fed through a lowpass filter to eliminate harmonics above the speech range, caused by clipping. Next it goes to a frequency modulator consisting of Q_{2005} (2SC2786L) and D_{1005} (1SV68), where the 10.81 MHz oscillating frequency is modulated, corresponding to the AF signal from Q_{2004} . Thus, an FM signal of 10.81 MHz is produced. This signal is then delivered to the IF amplifier, Q_{1010} , and the signal path then becomes identical to that of the SSB signal.

CW/AM

For CW, the 10.8107 MHz carrier is generated by Q_{1013} (2SC2603E), and delivered to the balanced modulator Q_{1012} . The key line is connected to keying control IC (quad NOR gate) Q_{2010} (MC14001B), which drives keying switch Q_{2009} (2SC2603E) to control the DC bias voltage sent to the source of Q_{1010} and Q_{2019} . As a result, the RF signal is turned on and off.

From this point, the signal path is identical to that of the SSB signal.

The control signal from Q_{2010} is also fed to the sidetone oscillator consisting of two sections of gate circuits in Q_{2010} , which oscillate sidetones of about 800 Hz and the sidetone signal is then delivered to the AF amplifier.

During AM operation, the amplified speech signal from Q_{2003} is amplified by another amplifier, Q_{2006} (2SC2603E), and the output signal controls the voltage at gate 2 of Q_{2019} . Thus, the CW carrier signal is modulated and delivered to the driver/final amplifier section.

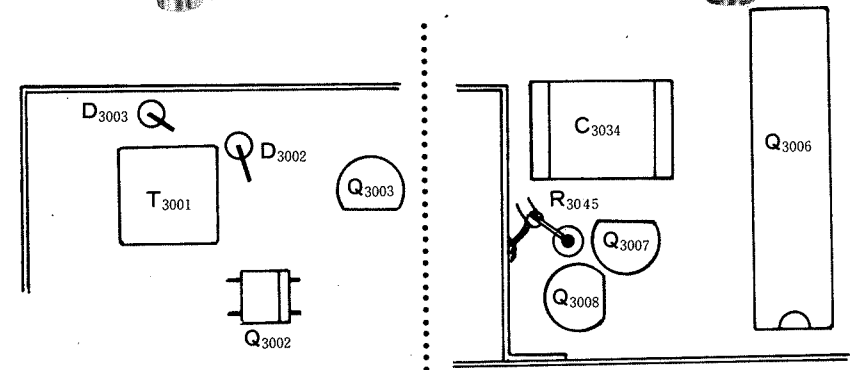
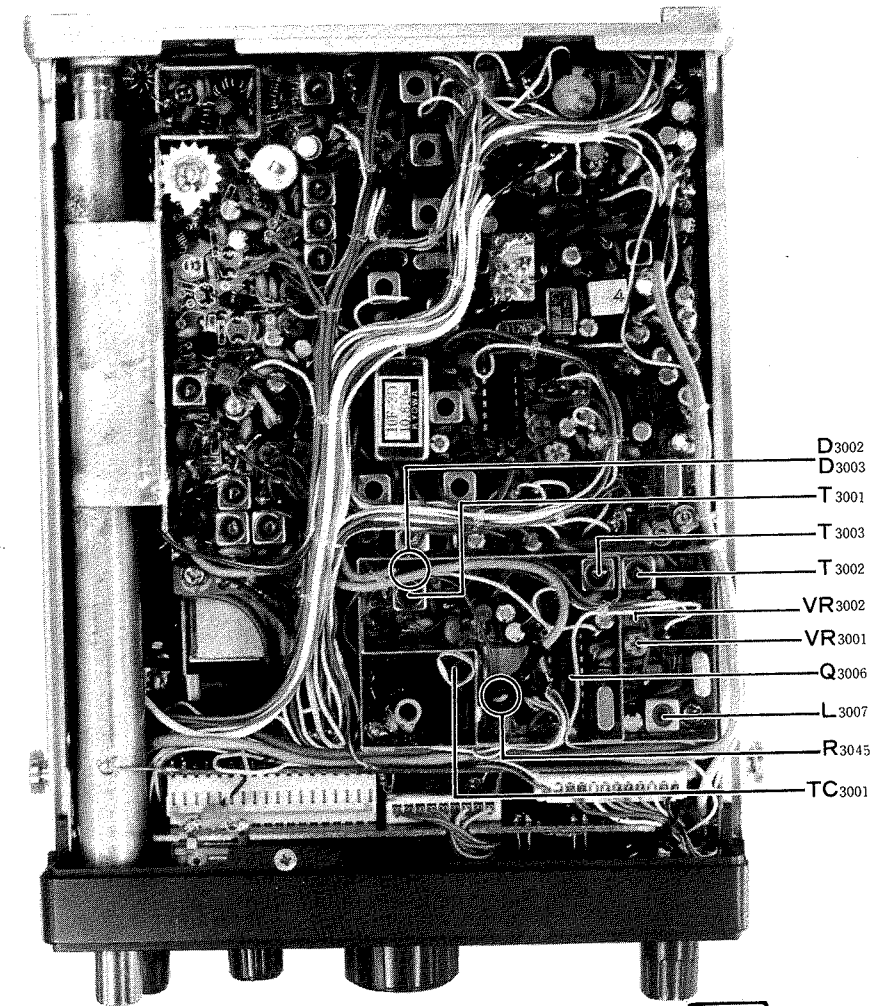

PLL SECTION ALIGNMENT POINTS

PLL CIRCUIT ALIGNMENT

The PLL circuit alignment procedure is very critical because of the ambient temperature change. This alignment must be performed under temperature conditions between the range of 15 to 30°C. If your transceiver is exposed to temperatures beyond this range for an extended period of time, the transceiver should sit in the proper alignment temperature for at least two hours before you start the following alignment procedure.

1. PLL Local, IF Alignment

- (a) Set the MODE switch to the FM position, and adjust the frequency to 52.000.0 MHz.
- (b) Set TC₃₀₀₁ to the center position, and connect an oscilloscope to pin 14 of Q₃₀₀₆.
- (c) Adjust the cores of T₃₀₀₁ – T₃₀₀₃ for maximum amplitude on the oscilloscope.

2. VCV Line Adjustment

- (a) Tune the transceiver to 54.000.0 MHz, and connect a DC voltmeter to R₃₀₄₅.
- (b) Adjust TC₃₀₀₁ for a reading of 5.5 volts on the meter.

3. PLL Local Frequency Adjustment

- (a) Set the MODE switch to FM and tune the transceiver to 52.000.0 MHz. Preset VR₃₀₀₁ and VR₃₀₀₂ to the center position.
- (b) Connect a frequency counter to the cathode of D₃₀₀₂ or D₃₀₀₃.
- (c) Adjust the core of L₃₀₀₇ for the frequency of 62.810.0 MHz.
- (d) Now turn the CLAR switch on, and rotate the main knob one click counterclockwise (1 step) displayed "1.999.9" (51.999.9 MHz).
- (e) Adjust VR₃₀₀₁ and VR₃₀₀₂ for a frequency of 62.809.9 MHz.
- (f) Repeat the alignment from step (c) to (e) a few times to be sure the proper frequency is obtained.

Tone Burst Circuit

When the T. CALL switch is pressed, the base of Q₄₀₀₂ (2SA733P) is grounded and a DC voltage is applied to tone burst oscillator Q₄₀₀₁ (TC5082P) to generate a 1800 Hz tone signal. The tone is superimposed on the transmit signal as long as the switch is held.

ALC Circuit

A portion of the RF signal is coupled through C₀₈ to a rectifier circuit consisting of D₂₀₀₇ and D₂₀₀₈ (1S188FM), producing a DC voltage. The DC voltage is amplified by DC amplifier Q₁₀₁₄ (2SC2603E) and fed to gate 2 of Q₁₀₁₀ to control its gain, thus preventing overdrive. The ALC level is adjusted by VR₂₀₀₃ for proper gain at Q₁₀₁₀.

Power Control Circuit

When the HI/LOW switch is set to the low position and the base of Q₂₀₀₇ (2SC2603E) to a high level, the voltage at the corrector becomes low, thus reducing the voltage at gate 2 of Q₂₀₁₉ (3SK59GR) and the amplitude of the RF signal.

PLL Circuit

The PLL circuit is composed of a reference crystal oscillator, programmable divider, VCO (voltage controlled oscillator), PLL local mixer, PLL local oscillator, lowpass filter and phase comparator. The PLL produces the local signal for the receiver and transmitter stages, using a synthesis scheme which utilizes 100 Hz steps throughout the range.

The VCO oscillator, Q₃₀₀₁ (2SK192GR), generates a signal at 60.81 – 64.8099 MHz. The oscillator frequency is controlled by varactor diode D₃₀₀₁ (1T25), which varies the capacitance of the oscillator tuned circuit in accordance with the control voltage supplied from an active lowpass filter consisting of Q₃₀₀₇ (2SK30AY), and Q₃₀₀₈ (2SC945P).

The output signal from Q₃₀₀₁ is amplified by buffer Q₃₀₀₂ (3SK73Y), and delivered to TX mixer Q₂₀₁₇/Q₂₀₁₈ and RX mixer Q₁₀₀₂. A portion of the local signal from Q₃₀₀₂ is fed through buffer Q₃₀₀₃ (2SK168D) to the PLL local mixer, Q₃₀₀₄ (2SC535A), where the signal is mixed with a PLL local signal generated by Q₃₀₀₉ (2SC535A) and multiplied 3 times by Q₃₀₁₀ (2SC535A). This local signal varies from 58.81 – 58.8199 MHz as a result of the control voltage from the CONTROL Unit. Thus, a PLL IF frequency of 2.00 – 5.99 MHz is obtained. The frequency varies at the PLL local signal, providing movement in 10 kHz steps.

This PLL IF signal is then amplified by Q₃₀₀₅ (2SC535A), and fed to Q₃₀₀₆ (μ PD2819C), where the programmable divider section divides the IF signal by 200 – 599, depending on the data from the 4-bit microprocessor in the CONTROL Unit.

Next, this signal is delivered to the phase comparator section, where the phase of divided IF signal is compared with its reference signal of 10 kHz. This reference signal is generated and divided by the reference oscillator/reference signal divider section in Q₃₀₀₆. Any difference in phase of the divided PLL IF signal with that of the PLL reference signal is converted into an error-signal with a different bandwidth of pulse. This signal is then fed to active lowpass filters Q₃₀₀₇ and Q₃₀₀₈, resulting in a VCO correction voltage.

When the PLL is unlocked, an unlock signal at pin 7 of Q₃₀₀₆ drops to a low level, cutting off the bias voltage at Q₂₀₀₉ (2SC2603E), and thus turning off Q₂₀₁₉ (3SK59GR) and Q₁₀₁₀ (3SK73Y).

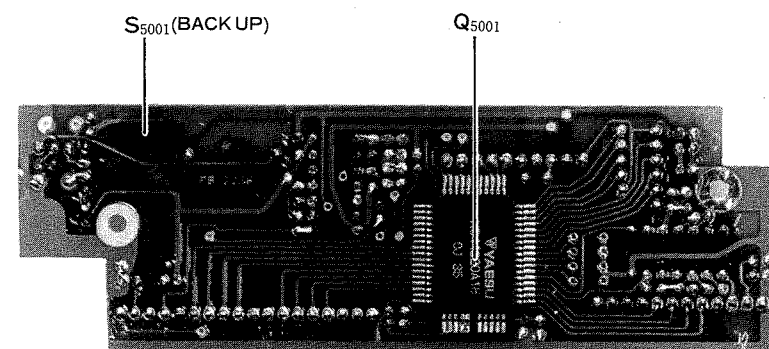
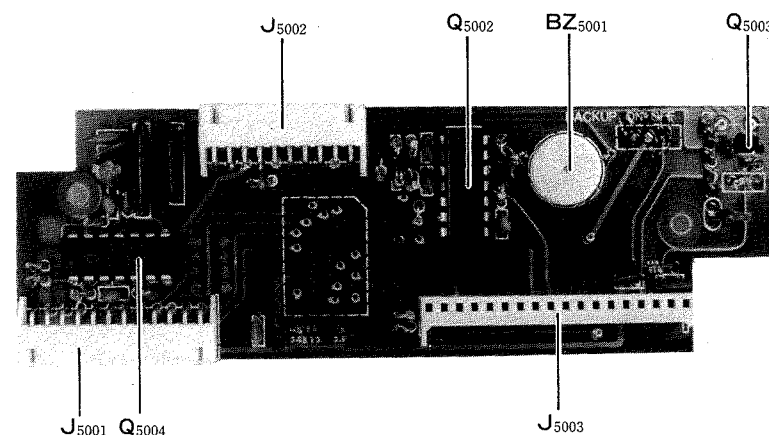
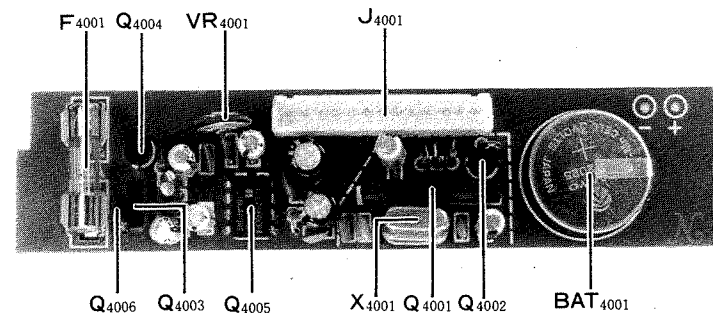

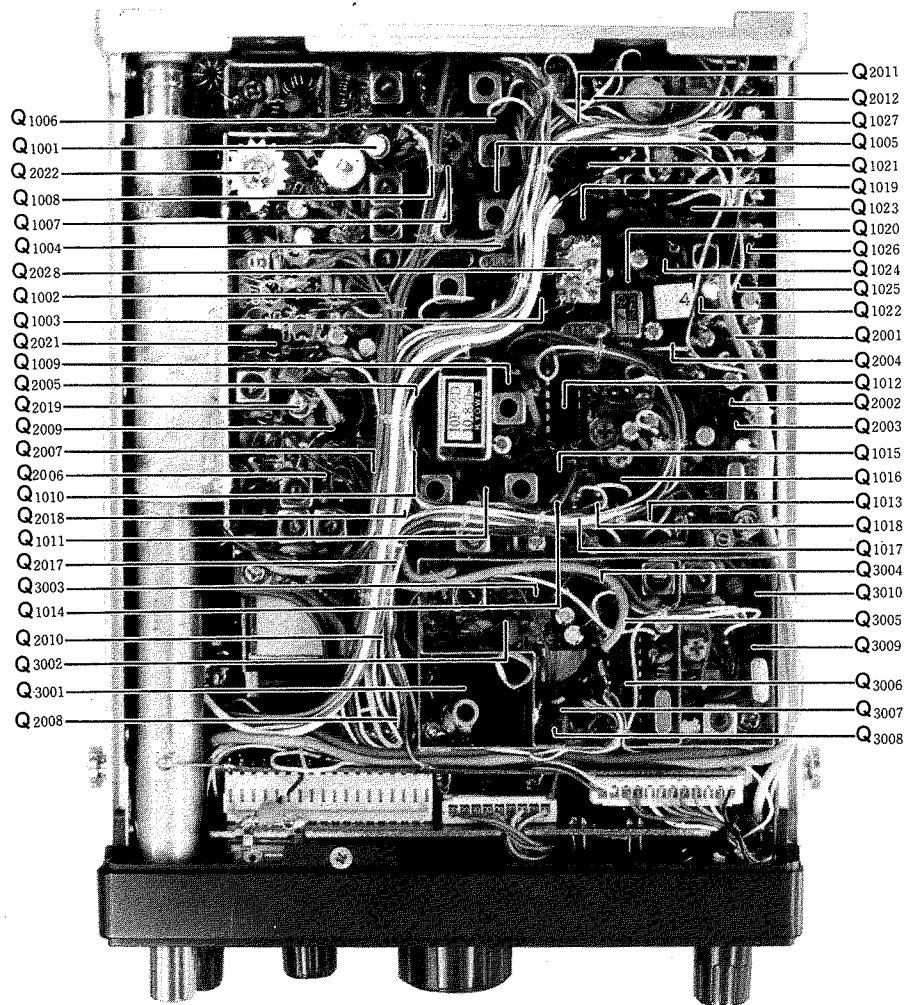

PLL Control Circuit

The PLL Control Unit features a low current drain 4-bit microprocessor chip, Q₅₀₀₁ (HD44820A18), which processes data for controlling the operating frequency, UP/DOWN scanning, priority channel, memory selection, etc. The CPU processes input data by means of the main dial or other control switches in accordance with the program stored in a ROM for control of the PLL frequency, indication of the operating frequency, or memory channels on digital display.

MAINTENANCE AND ALIGNMENT

This equipment has been carefully aligned and tested at the factory prior to shipment. If the instrument is not abused, it should not require other than the usual attention given to electronic equipment.

Service or replacement of a major component may require considerable realignment. Under no circumstances, though, should realignment be attempted unless the operation of the transceiver is fully understood, the malfunction has been carefully analyzed, and the fault has definitely been traced to misalignment rather than part failure. Service work must only be performed by experienced personnel using the proper test equipment.

Never align this transceiver without having a 50 ohm dummy load connected to the antenna jack. Troubleshooting using an antenna can result in misleading indications on the test equipment.

EQUIPMENT REQUIRED

1. RF Signal Generator: Hewlett-Packard Model 8640B or equivalent with one volt output at 50 ohms and frequency coverage to 150 MHz.
2. Vacuum Tube Voltmeter (VTVM): Hewlett-Packard Model 410B or equivalent.
3. Dummy Load/Wattmeter: Yaesu YP-150Z or equivalent.
4. AF Signal Generator: Hewlett-Packard Model 200AB or equivalent.
5. IF Sweep Generator: capable of output at 10.81 MHz.
6. RF Sweep Generator: capable of output at 49 – 55 MHz.
7. Oscilloscope: Hewlett-Packard Model 1740A or equivalent.
8. FM Deviation Meter: coverage to 50 – 54 MHz.
9. Precision Frequency Counter: Yaesu Model YC-500E or equivalent with resolution to 0.01 kHz and frequency coverage to 150 MHz.

