

**FT-690R
CIRCUIT DIAGRAM**

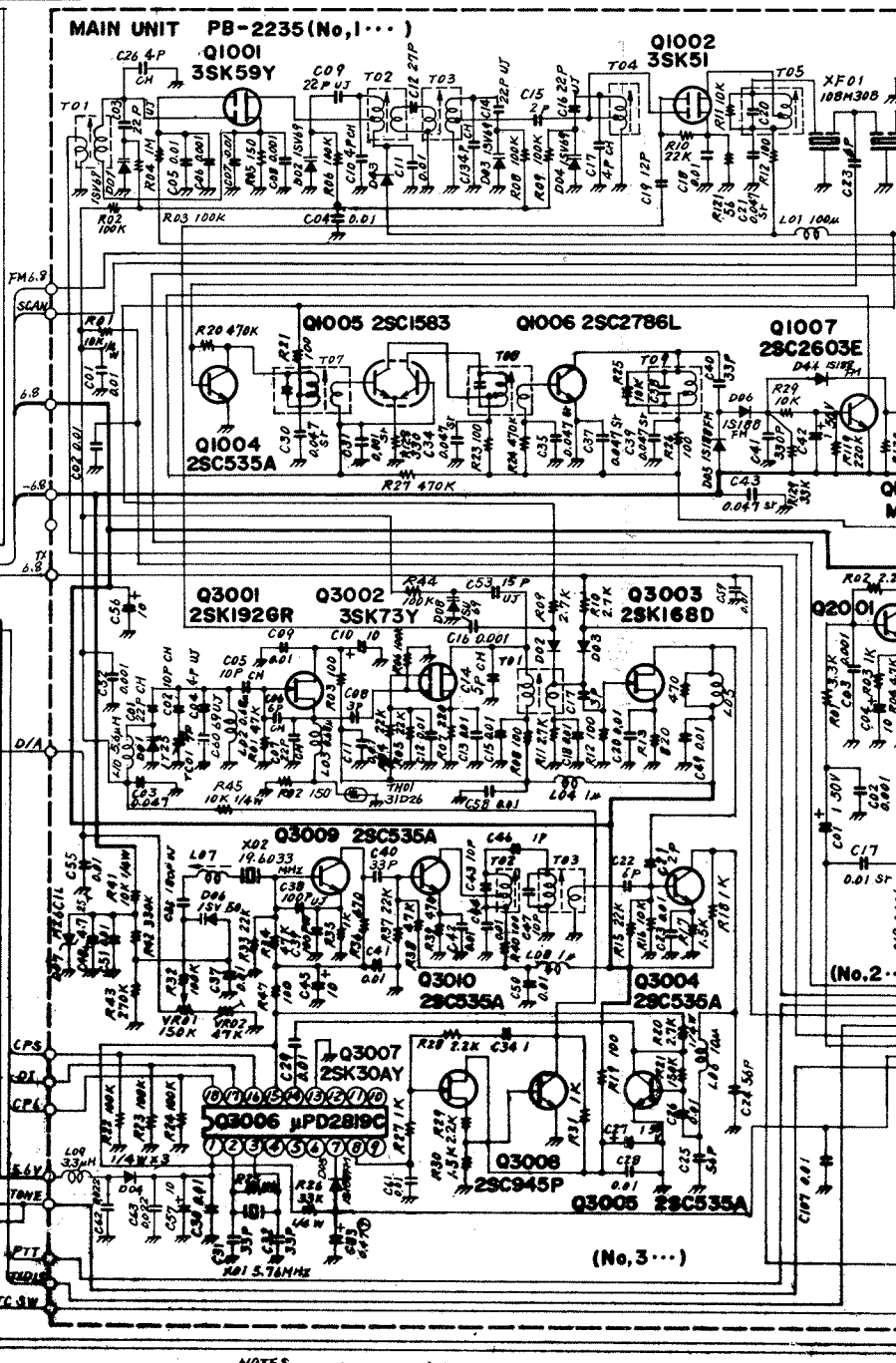

- NOTES**
1. ALL RESISTORS ARE IN Ω UNLESS OTHERWISE NOTED.
 2. ALL CAPACITORS ARE IN μ F UNLESS OTHERWISE NOTED.
 3. ALL DIODES ARE 1SS53 UNLESS OTHERWISE NOTED.
 4. ALL ELECTROLYTIC CAPACITORS ARE 16V UNLESS OTHERWISE NOTED.

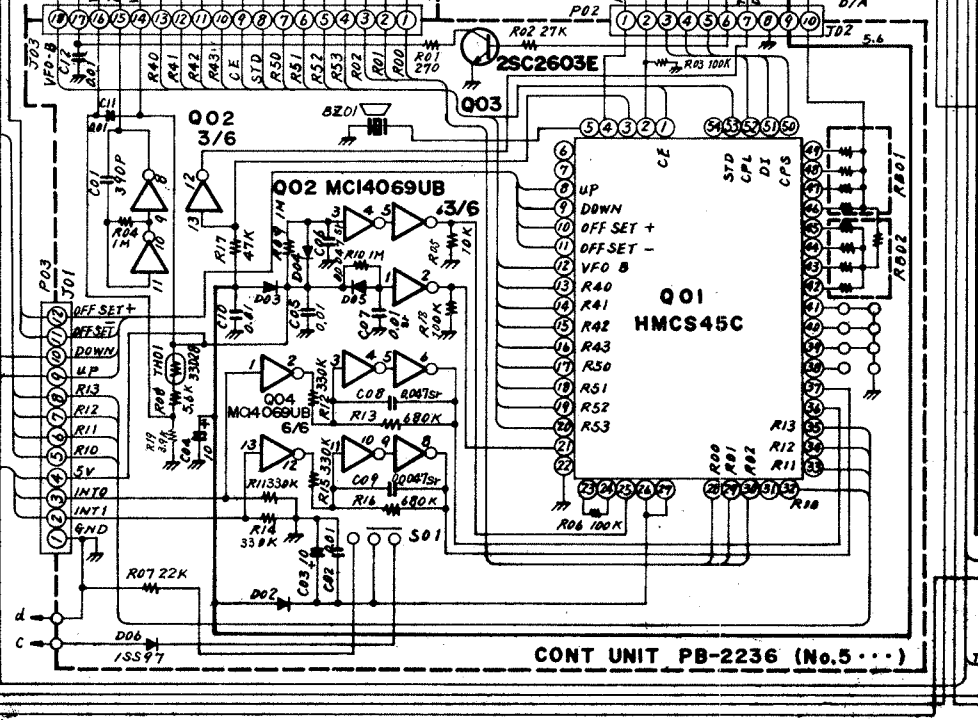
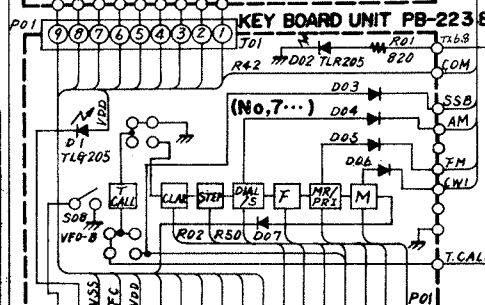
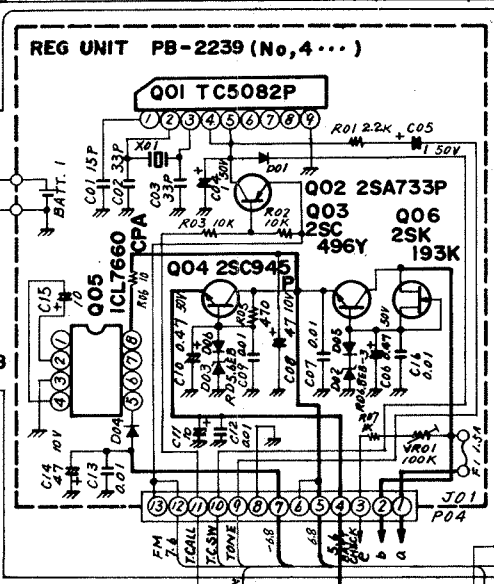
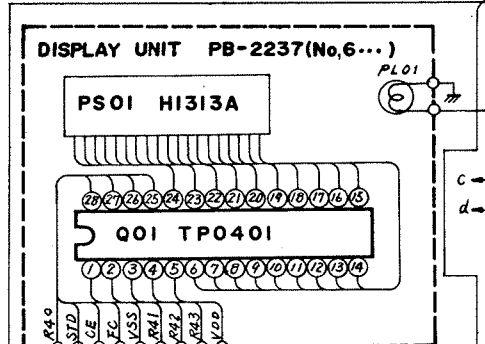
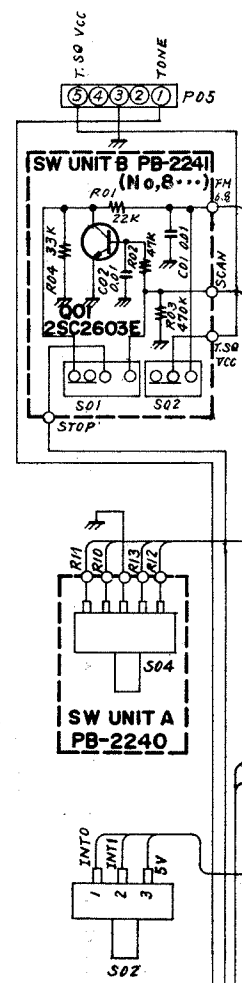
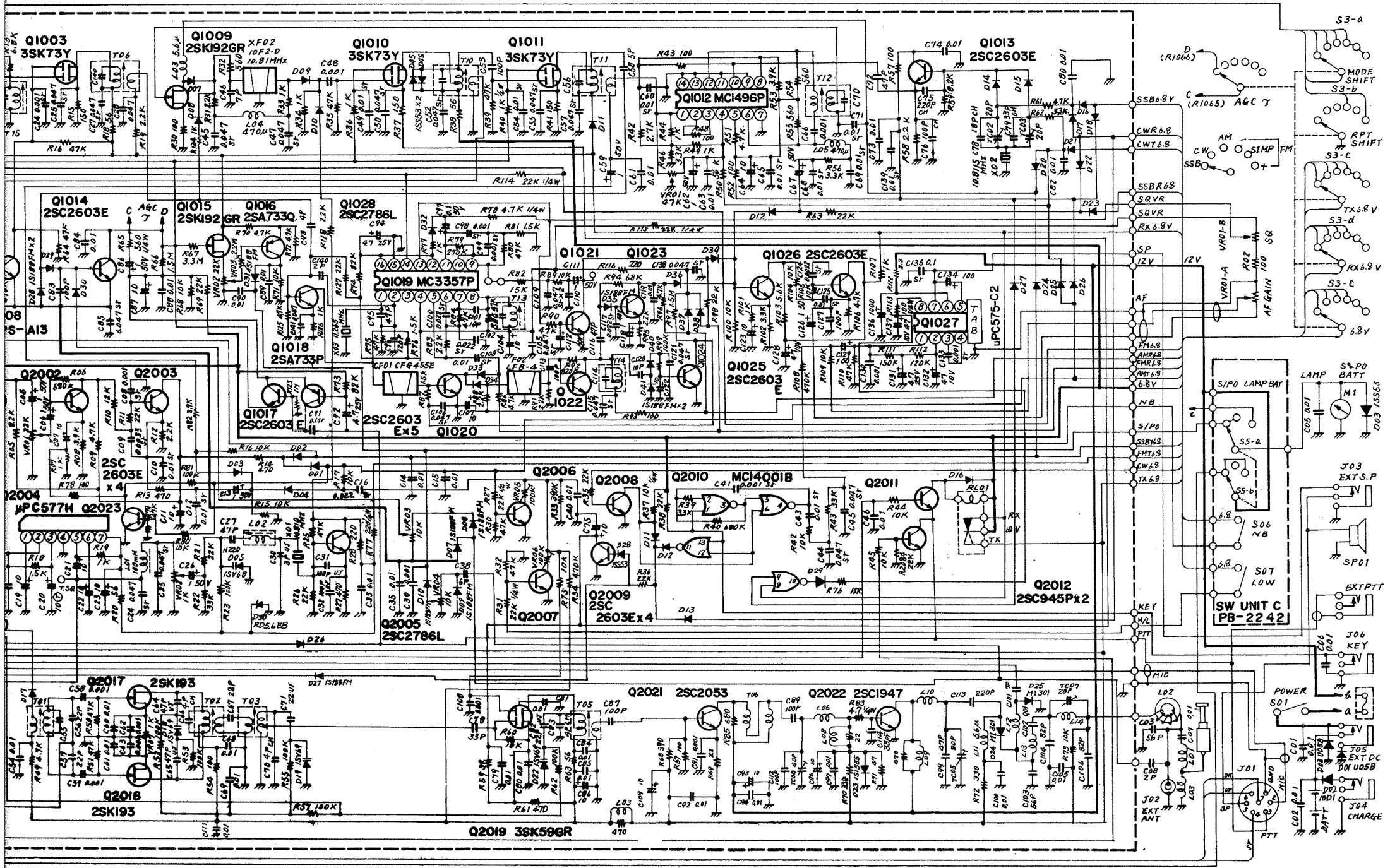

5. VALUE IS NOMINAL.

NOTED.