

OPERATING MANUAL

FT-4700RH

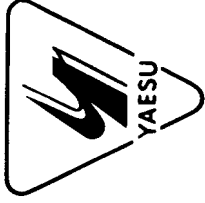

YAESU MUSEN CO., LTD.
C.P.O. BOX 1500
TOKYO, JAPAN

CONTENTS

FT-4700RH

DUAL BAND VHF/UHF FM TRANSCEIVER

SUPPLIED ACCESSORIES	2	Selective Band Receiver	25
ACCESSORIES/OPTIONS	2	Muting	25
MODEL CHART	2	Transmitting	26
SPECIFICATIONS	3	Repeater Splits	27
CONTROLS & CONNECTORS	4	Setting Standard Repeater	28
FRONT PANEL	4	Offset	29
REAR PANEL	8	Automatic Repeater Shift	30
INSTALLATION	10	Simple Memory Storage & Recall	31
Antenna Considerations	10	Recalling Memories	31
Mobile Installation	11	Alternating Band Memory Selection	31
Mobile Power Connections (12)	11	Call Channel Memory	32
Base Station Installation	14	Separate Transmit Frequency Memories	32
Packet Radio TNC Interconnections	14	Memory Tuning	32
External Accessories	15	Hiding and Erasing Memories	33
INSTALLATION OF OPTIONS	16	Scanning	34
FTS-8 Tone Squelch Unit Installation	16	Memory Skip Scanning	34
YSK-4700 Trunk Mounting Kit Installation	18	Programmable Subband Limits	35
Memory Cloning	21	Priority Channel Monitoring	36
OPERATION	22	Scan Stop Beeper Disable	37
Preliminary Operating Information	22	Tone Squelch Operation	37
Squelch Setup	23	FTS-8 CTCSS TONE FREQUENCIES (37)	38
Band Selection	23	In Case of Problems	38
Frequency & Step Selection	24	Resetting the CPU	38
CHANNEL STEP SELECTION (24)	24	Memory Backup	39
Dual Band Reception	24		

The trunk-mountable FT-4700RH is a high power FM dual band mobile/base transceiver providing 50 watts of power output on the 2m amateur band, and 40 watts of power output on the 70cm amateur band. 5 watts low power is also selectable on both bands. The front panel can be detached and mounted conveniently on the dashboard, while the main body of the transceiver is installed under a seat or safely hidden in the trunk, using the YSK-4700 controller cable option to interconnect the panel and main body.

Operating features include memory selection and tuning in 5, 10, 12.5, 20 and 25 kHz selectable steps. Twenty memories (ten per band), include a one-touch recall CALL channel memory for each band. Convenient control features include repeater reverse; selectable subband limits and selected memory scanning with auto-resume after carrier drop or 5-second pause; and priority channel monitoring. Memory hiding and scan skip can be set easily to limit channel selection and scanning to the channels you choose.

All memories store programmable repeater shifts, and ten of the memories can also store independent transmit and receive frequencies. Automatic Repeater Shift (ARS) can be enabled to provide repeater transmitter offset automatically when tuned to a standard repeater subband. Any of 37 standard CTCSS (subaudible) tone frequencies (plus 97.4 Hz) can be displayed, selected and programmed into any memory channel for transmission and silent monitoring when the optional FTS-8 Unit is installed (two FTS-8 Units required for tone squelch operation on both bands).

True full-duplex crossband operation, originated by Yaesu for amateur radio in the FT-2700RH, is carried forward in the FT-4700RH, but with the added capability of simultaneous reception on both bands, and selectable auto-muting of the secondary band by signals on the primary band.

For European ops, a 1750 Hz burst tone generator is built-in and can be activated from the MH-14A8 or MH-14B8 Speaker/Mic. DTMF keypad microphone options include the MH-15C8 and the MH-15D8 with its own auto-dial DTMF memories for convenient autopatching.

Along with one microphone, the MMB-27 Quick-Release Mobile Bracket is supplied with the transceiver. For base station installations, the FP-700 AC Power Supply/External Speaker is optionally available.

Please read this manual before installing or operating the FT-1700RII.

SUPPLIED ACCESSORIES

- MMB-27 Quick-Release Mobile Mounting Bracket D6000039
- Power Supply Cable T9015605 with two 15A fuses, 2.8m
- One of the microphones in the following list.

ACCESSORIES/OPTIONS

Model	Order Code
AD-2 VHF/UHF Duplexer for 1-Ant Operation	
YSK-4700 Trunk Mounting Kit	D3000574
FP-700 Power Supply for AC Mains Operation	
FTS-8 Tone Squelch Unit (up to 2 required - one for each band)	D3000333
MH-14A8 Hand Microphone w/1750 Hz Burst Button	D1000051
MH-14B8 Hand Speaker/Mic w/1750 Hz Burst "	D1000052
MH-15C8 Hand Microphone w/DTMF Keypad	D1000060
MH-15D8 Hand Microphone w/DTMF Memory Keypad	D1000061
MF-1A3B Boom Microphone w/Flexible arm	
YH-1 Headset	
SB-10 PTT Switch Unit for MF-1A3B or YH-1	
SP-3 External Loudspeaker	
SP-4 External Loudspeaker w/Lowpass filter	

Some accessories may be supplied as standard per local regulations or operating requirements.

MODEL CHART

Version	Frequency Range (MHz)	Standard Repeater Split	Version	Frequency Range (MHz)	Standard Repeater Split
A1	144 ~ 148 430 ~ 450	± 600kHz ± 5MHz	C1	144 ~ 146 430 ~ 440	± 600kHz ± 1.6MHz
A2	TX: 140 ~ 150 RX: 140 ~ 174 430 ~ 450	± 600kHz ± 5MHz	C2	144 ~ 148 430 ~ 440	± 600kHz ± 1.6MHz
B1			D	144 ~ 146 432 ~ 438	± 600kHz ± 1.6MHz
B2	144 ~ 146 430 ~ 440	± 600kHz ± 7.6MHz	H1	144 ~ 146 430 ~ 440	± 600kHz ± 5.0MHz
	144 ~ 148 430 ~ 440	± 600kHz ± 7.6MHz	H2	144 ~ 148 430 ~ 440	± 600kHz ± 5.0MHz

SPECIFICATIONS

GENERAL	Maximum Deviation ±5 kHz
Channel Steps 5/10/12.5/20/25 kHz	Spurious Radiation less than -60dB
Mode of Emission F3	Microphone Impedance 2 kilohms
Antenna Impedance 50 ohms, unbalanced	RECEIVER
Supply Voltage 13.8V DC ±15%, negative, ground	Circuit Type Double Conversion Superhet
Current Consumption (typical) Receive: 600 mA Transmit High/Low: 10/3 A	Intermediate Frequencies VHF: 17.3 MHz & 455 kHz UHF: 47.75 MHz & 455 kHz
Operating Temperature Range -20 to +60°C	Sensitivity (12dB SINAD) better than 0.158 uV
Case Size (WHID) 150 x 50 x 180mm	Selectivity (-6/-60dB) 15/30 kHz
Weight 2 kg (4.4 lb)	Image Rejection better than 65dB
TRANSMITTER	Squelch Sensitivity at least 0.1uV
Output Power (High/Low) VHF: 50W/5W UHF: 40W/5W	Maximum AF Output 1.5W into 8 ohms @5% THD
Modulation Type Variable Reactance	AF Output Impedance 4 to 16 ohms (8-ohm internal speaker)

Specifications subject to change without notice or obligation.

CONTROLS & CONNECTORS

FRONT PANEL

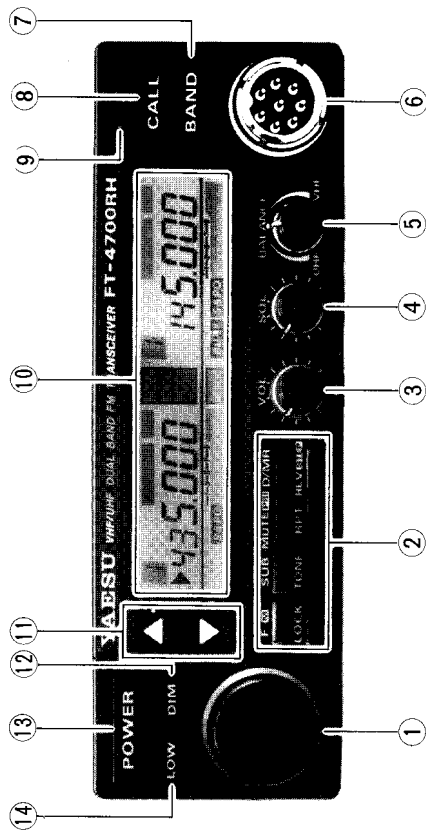

(1) Selector Knob

This 50-position detented rotary switch is used for tuning as well as a wide variety of function selections. The DWN and UP keys on the microphone duplicate the functions of this knob.

(2) Function Keys

These eight keys select the various operating features. One or more beeps will sound if the resulting command is accepted. The backlit labels above the keys indicate their primary functions. However, if the F[M] key is pressed first, most of these keys will perform alternate functions, described later and shown on the Reference Card.

For descriptive purposes in this manual, alternate key functions are referenced by preceding the key name with "[F]+" in front of it to remind you to press the F[M] key first. For example, "[F]+SUB" indicates that you should press the F[M] key followed by the SUB key (within five seconds).

(3) VOL Control

This control adjust the volume of the receiver audio (both receivers together if dual receive is active). The function key beeper volume is also set by this control.

(4) SQL Control

This control sets the threshold level at which received signals (or noise) on the primary band open the squelch. For maximum squelch sensitivity set this control from counterclockwise just to the point where noise is silenced (and the BUSY indicator on the display is off) when the channel is clear. This control does not affect reception on the secondary band.

(5) BALANCE Control

This control adjusts the relative balance of receiver audio between the VHF and UHF bands, when receiving on both.

(6) MIC Jack

This 8-pin jack accepts microphone input, band selection and scanning control from the microphone, and provides receiver audio (for a speaker/mic). Also, memory cloning can be performed with another transceiver through this jack. Pinout is shown on page 7.

(7) BAND Button

Press this button to exchange the primary and secondary bands. A low-pitched beep sounds when changing the primary band from 2m to 70cm, and a high-pitched beep sounds when changing from 70cm to 2m. If the F[M] key is pressed first, this button selects/deselects alternating band memory selection, described in the Operation section.

(8) CALL Button

Press this button to jump to the calling channel memory on the primary band. Press [F]+SUB followed by this button to jump to the calling channel memory on the secondary band.

(9) ON AIR Indicator Lamp

This LED glows red when transmitting.

(10) Display

The display segments are follows.

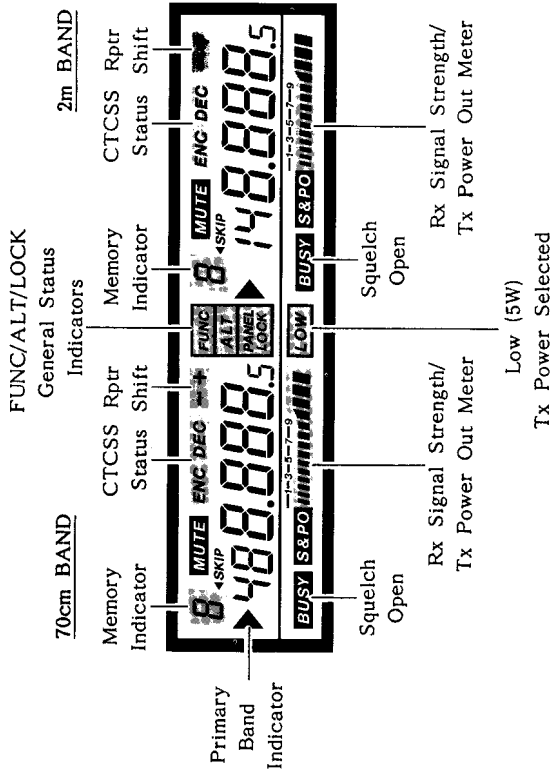

(11) ▲/▼ Buttons

These up and down buttons are usually used to step the primary band frequency up or down 1 MHz, but during CTCSS tone, channel step and repeater shift selection they may also be used in place of the tuning knob for making a selection. Also, when operating on a memory, pressing one of these buttons (once) enables retuning of the memory.

(12) DIM Button

Press this button to select between the two levels of display backlighting. Press [F]+DIM to deactivate/activate the beeper during scan stop.

(13) POWER Switch

This two-position push button turns the transceiver on and off.

(14) LOW Button

This button toggles between high and low transmitter power output. Both bands are affected. When low power is selected, "LOW" appears at the bottom center of the display.

REAR PANEL

(4) 13.8VDC Cable Pigtail

This is the power supply connection for the transceiver. Use the fused DC cable supplied with the transceiver to make connection between this pigtail and the car battery or other DC power supply capable of at least 10 Amperes (continuous). Make certain that the red lead connects to the positive side of the supply.

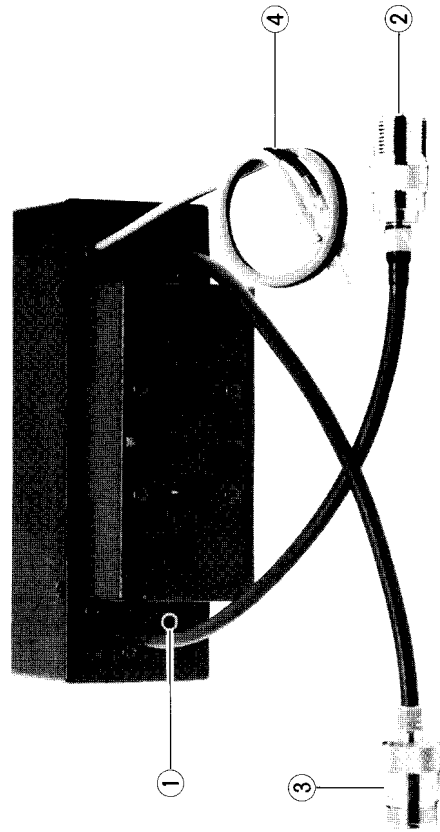

(1) EXT SP (External Speaker) Jack

This 2-contact mini phone jack accepts a 4- to 16-ohm external speaker such as the Yaesu SP-3, SP-4 or SP-55. When a plug is inserted into this jack the internal speaker is disabled.

(2) VHF ANT (Antenna) Jack

Connect a 2m-band antenna to this type-M socket using 50-ohm coaxial cable and a type-M plug. Make sure the antenna is designed specifically for use at the operating frequency.

NOTE: If you have an antenna specifically designed for dual-band 2m/-70cm operation, use the Yaesu AD-2 Antenna Duplexer to combine the VHF and UHF antenna jacks.

(3) UHF ANT (Antenna) Jack

Connect a 70cm-band antenna to this type-N socket using 50-ohm coaxial cable and a type-N plug. Make sure the antenna is designed specifically for use at the operating frequency (also see the NOTE above).

INSTALLATION

Antenna Considerations

The FT-4700RH is designed for use with antennas having an impedance near 50 ohms at all operating frequencies. For optimum performance use a high-quality, carefully designed antenna. The antenna should be connected at all times when power is on, to avoid damage that could otherwise result if transmission occurs accidentally when no antenna is connected.

As noted on the previous page, you can use an antenna specifically designed for operating on both 2m and 70cm, but make sure it is designed to handle 50W continuous transmitter power. Use the Yaesu AD-2 Antenna Duplexer to connect the ANT sockets to the antenna feedline.

For best performance and safety in mobile installations, mount the antenna in the center of a flat surface on the car body, out of reach of human hands. Remember: 50 watts can cause an RF burn to anyone touching the antenna during transmission!

For optimum performance use the shortest possible length of the best quality coaxial cable available, and be sure to use a properly matching plug for the jack on the transceiver or duplexer.

Mobile Installation

The FT-4700RH must only be installed in cars having a negative ground electrical system. The transceiver can be installed in one piece using the supplied MMB-27 quick-release bracket as described below, or in two pieces when the optional YSK-4700 Trunk Mount Kit is used (page 18).

One-Piece Mounting

Mount the transceiver where the display, controls and microphone are easily accessible, using the supplied MMB-27 mobile mounting bracket. The transceiver may be installed in any position without adversely affecting its performance, but it should not be mounted near a heater vent or where it could interfere with safe operation of the vehicle. Make sure that plenty of space is provided at the rear of the transceiver so that air can flow freely through the heatsink. Refer to the diagrams on the next page for installation of the MMB-27.

(1) Using the mounting bracket as a template, locate the mounting holes after determining the mounting location with sufficient clearance for the transceiver, and space for ventilation around the heatsink. Use a 4.8mm (3/16") bit to drill the holes. Secure the bracket with the supplied screws, washers and nuts (Fig. 1).

(2) Screw the mounting rings to the sides of the transceiver using the supplied spacers and flat washers (Figure 2). Make sure the rings are oriented as shown.

To install the transceiver, align the mounting rings with the notches in the bracket (Figure 3), and slide the transceiver in and up into the bracket until it snaps into place.

To remove the transceiver, reach around to the rear and pull forward and slightly downward on the heatsink. DO NOT PULL ON THE FRONT PANEL, as it could be damaged.

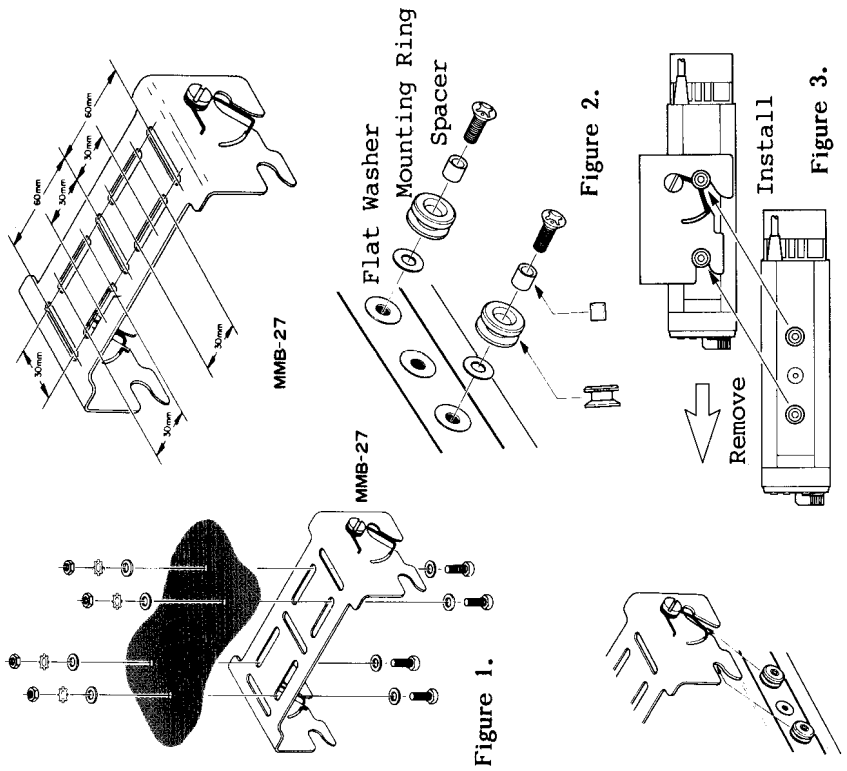

Mobile Power Connections

Before connecting the power cable the peak battery charging voltage should be checked to ensure that it remains below 15V when the engine is revved. If more than 15V is found at the battery terminals, the car voltage regulator should be adjusted before connecting the transceiver.

Power connections should be made directly to the automobile battery using the supplied cable with 15A in-line fuses. Connection to the cigarette lighter or other accessory circuit may cause the fuse to blow in that circuit. Connecting the supplied DC power cable to the battery independently of the rest of the automobile electrical system will minimize possible ignition noise pickup and excessive supply voltage drop during transmission, while allowing operation with the ignition off.

Do not connect any power to the transceiver except via the supplied fused cable, and do not attempt to defeat or bypass the fuses - they are there to protect you and the equipment.

Connect the RED lead of the power cable to the POSITIVE (+) battery terminal, and the BLACK lead to the NEGATIVE (-) terminal. If it is necessary to extend the power cable, use #14 AWG or larger insulated, stranded copper wire, and in all cases use the minimum power cable length practicable to keep voltage drop minimal.

After connecting the cable to the battery, connect the other end to the power pigtail on the transceiver.

WARNING

NEVER APPLY AC POWER TO THE REAR PANEL POWER JACK OF THE TRANSCEIVER. NEVER CONNECT DC VOLTAGE OF MORE THAN 15 VOLTS TO THE POWER JACK. ALWAYS REPLACE FUSES WITH 15A RATING. FAILURE TO OBSERVE THESE PRECAUTIONS WILL VOID THE WARRANTY.

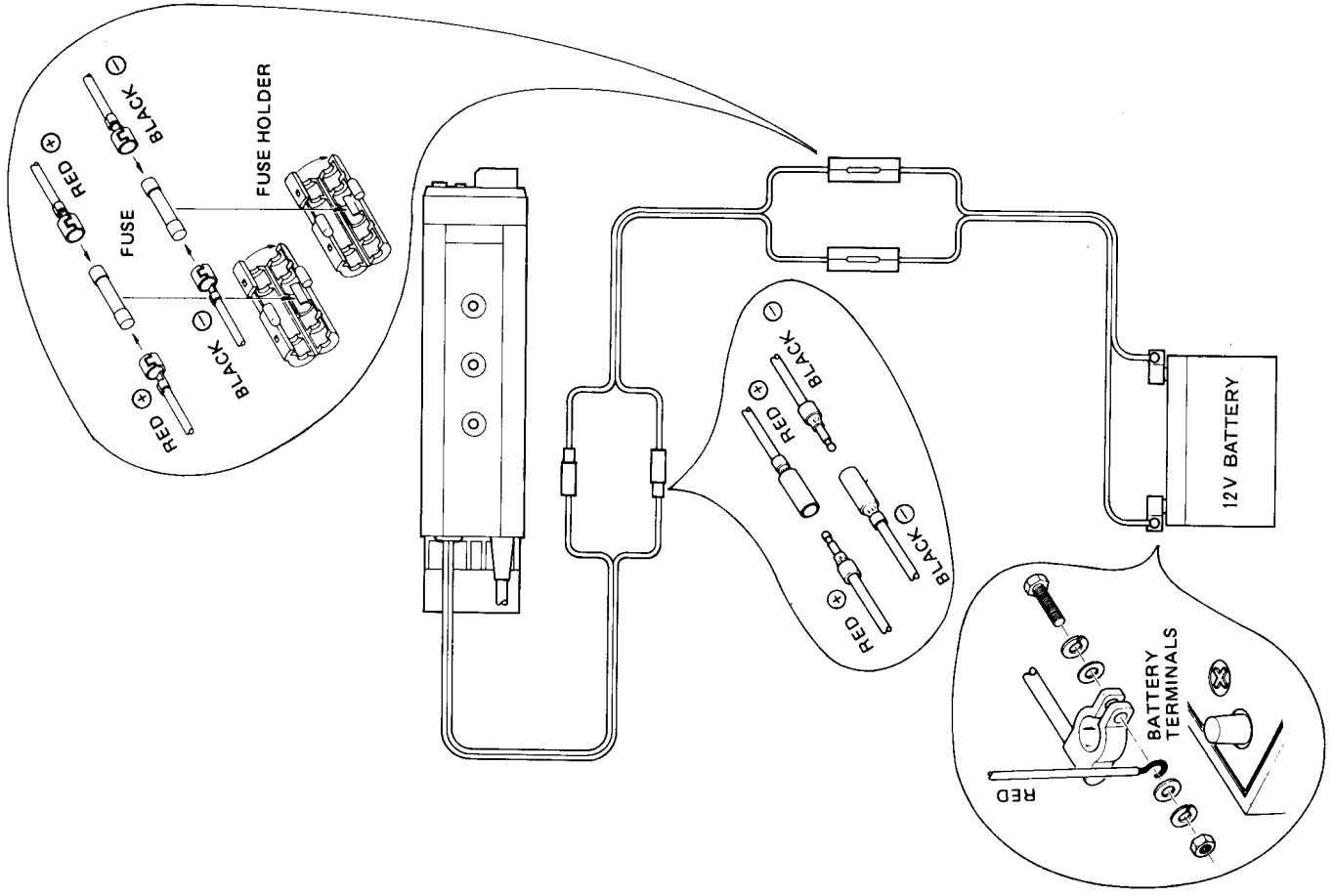

Base Station Installation

A power supply capable of providing at least 10A continuously at 13.8VDC is required for operation from the AC line, and an external speaker is recommended. The FP-700 AC power supply/loudspeaker is available from your Yaesu dealer for this purpose. Use the fused DC power cable supplied with the transceiver for making power connections, and connect the external speaker to the EXT SP jack on the rear panel.

Packet Radio TNC Interconnections

Most popular packet radio tncs can be connected to the MIC jack of the FT-4700RH as follows:

TNC Jack to Radio	FT-4700RH MIC Jack
Receiver Audio in	pin 4 (8 ohms, de-emphasized)
PTT (gnd=tx) out	pin 6
Transmit Audio out	pin 8 (400 ohms, pre-emphasized)

Use shielded cable for the audio lines, and keep the interconnecting cable as short as possible to avoid RF pickup.

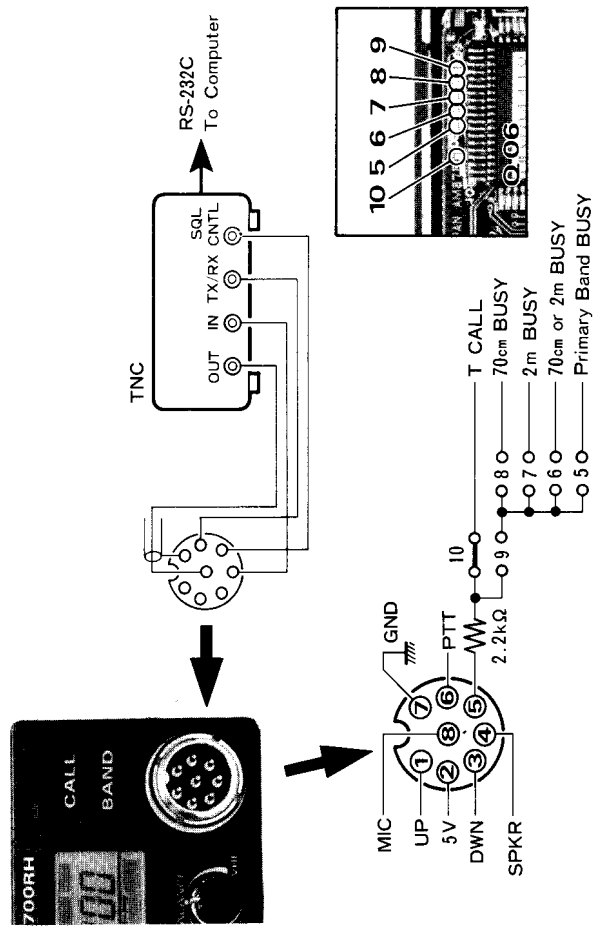

* Requires removing solder bridge jumper 10 on the inside of the front panel, and installing jumper 9 and one of jumpers 5-8.

External Accessories

The SP-3, SP-4 and SP-55 External Speakers are optional accessories which allow the source of audio from the transceiver to be repositioned for optimum hearing. Especially practical for the noisy mobile environment, each includes its own swivel-type mounting bracket, and is available from your Yaesu dealer. Also available to enhance safety and mobile operating convenience are the YH-1 Headset with miniature boom microphone, and the full size MF-1A3B boom microphone with flexible arm (both of which use the SB-10 PTT switch).

INSTALLATION OF OPTIONS

This section describes the installation procedures of the FTS-8 Tone Squelch Units and the YSK-4700 Trunk Mounting Kit. These options are available from your Yaesu dealer.

FTS-8 Tone Squelch Unit Installation

The FTS-8 includes an encoder and decoder for 37 EIA standard sub-audible CTCSS tones, programmable from the front panel of the FT-4700RH. Silent monitoring of busy channels is provided when the FTS-8 is activated by the ENCode/DECode Tone Squelch function. One FTS-8 must be installed for each band on which tone squelch is desired. See the "Operation" section for functional details.

- (1) Disconnect the DC power cable, and referring to Figure 1, remove the six screws affixing the top cover (to install the 2m FTS-8) and/or the bottom cover (to install the 70cm FTS-8). Be careful not to strain the speaker wires if installing the 70cm FTS-8.
- (2) Referring to Figure 2 for 2m or Figure 3 for 70cm, locate the 6-pin jack with only a jumper and a 56k $\frac{1}{4}$ -watt (green-blue-orange bands) resistor, and remove the jumper and resistor. These will not be needed again unless the FTS-8 is later re-moved.
- (3) Press the FTS-8 into the 6-pin and nearby 8-pin connectors, gently rocking it into place. The output tone level (VR1 on the FTS-8) is adjusted at the factory for the proper deviation, so no adjustment is needed.
- (4) Replace the cover(s) and screws removed in step 1.

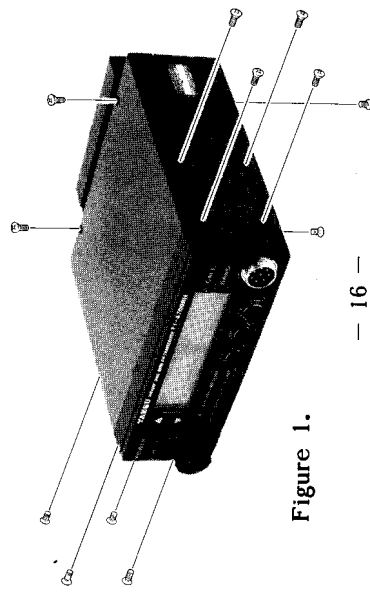

Figure 1.

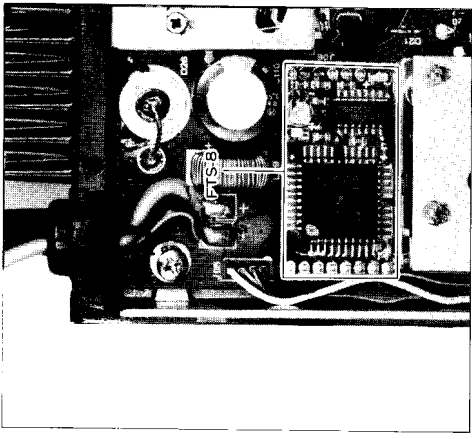
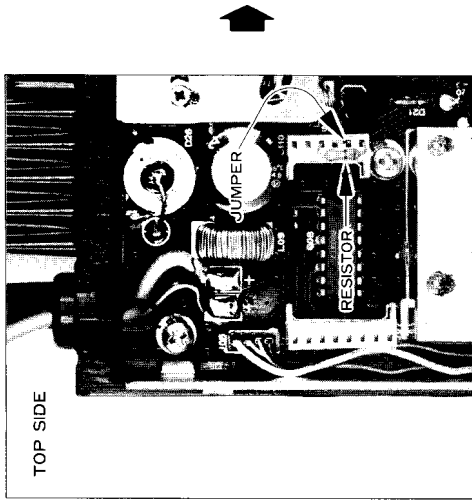

Figure 2.

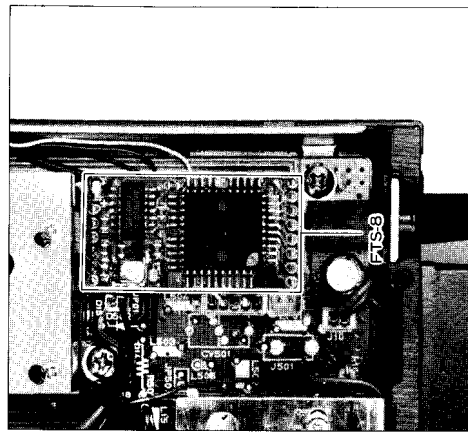
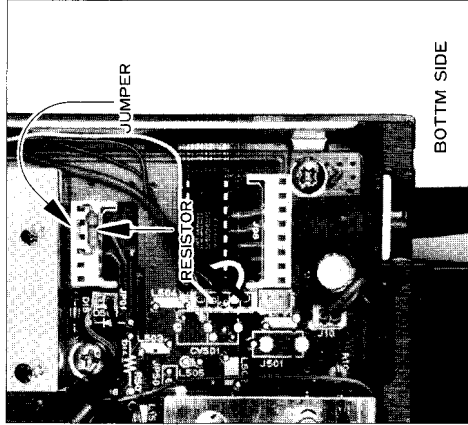
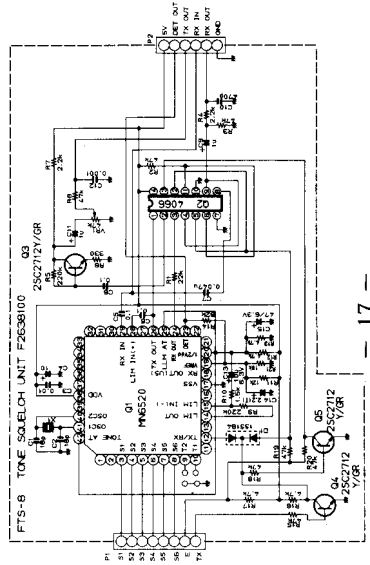

Figure 3.



YSK-4700 Trunk Mounting Kit Installation

The YSK-4700 kit consists of a blank front cover for the main body of the transceiver, a 3m interconnecting cable for the Controller, and Controller mounting hardware. This allows the main body of the transceiver to be installed under a seat, in the trunk, or anywhere else out of the way, while the Controller is mounted on the dashboard. A choice of Controller mounting methods allows the Controller to be easily removed and taken with you when leaving the vehicle.

To install the YSK-4700:

- 1) Disconnect the power cable, remove the two screws on each side affixing the Front Panel/Controller (Figure 4) and gently separate it from the transceiver chassis by first prying the top edge forward.
- 2) Disconnect the short interconnecting cable at the back of the Controller, and connect the mating end of the extension cable in its place. Attach the shield grounding lug on the extension cable braid to one of the vacated holes on the edge of the Controller (Figure 5).
- 3) Attach the supplied blank panel to the main chassis using three of the four screws (see Figure 6). Attach the shield grounding lug on this end of the extension cable braid at the remaining hole.
- 4) Mate the connectors at the main body, and then press connectors at both ends of the extension cable into the grooves on the blank panel and on the rear of the Controller (Figure 7).
- 5) The Controller Unit may be mounted in a convenient operating location using either the supplied hook & loop fastener tape or the small mounting bracket (Figures 8 and 9). However, be careful to observe the following mounting precautions:

DO NOT INSTALL THE MAIN BODY OF THE TRANSCEIVER NEAR A HEATING VENT, NOR IN A TIGHTLY CLOSED COMPARTMENT - THE HEATSINK NEEDS VENTILATION!

Remember that DC power must be supplied to the main body, and an external speaker (page 15) should also be connected unless you plan to use only a speaker microphone for receiver audio.

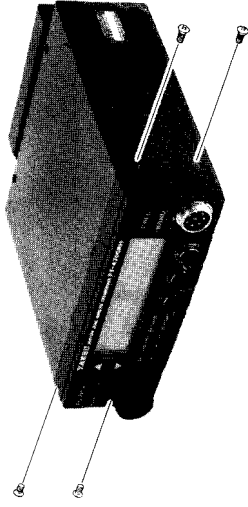

Figure 4

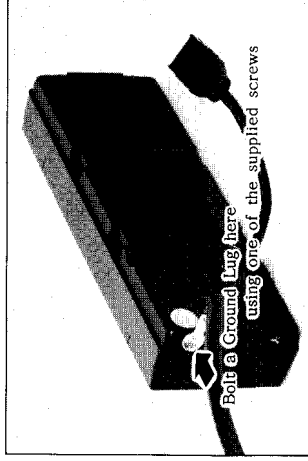

Figure 5.

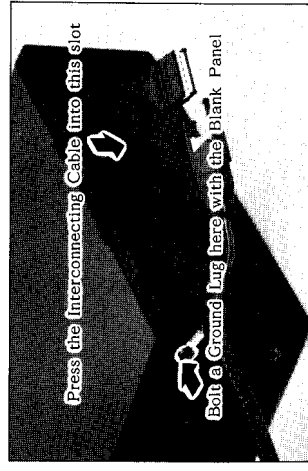

Figure 6.

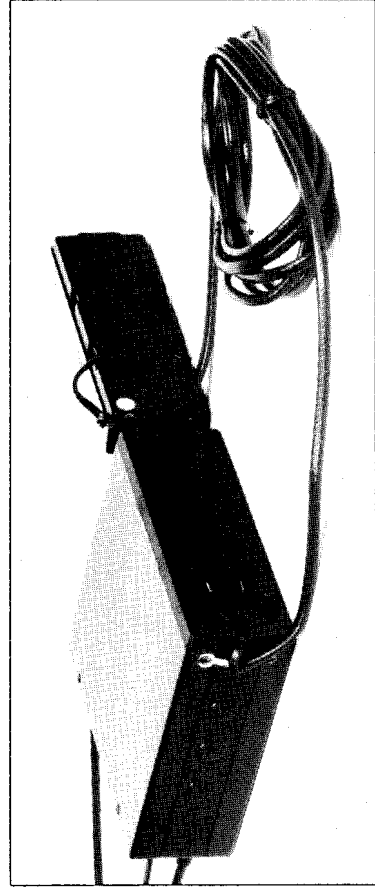

Figure 7.

Memory Cloning

All memory data stored in one transceiver can be moved to another by connecting the MIC jacks together as indicated in the diagram below (cloning cable is NOT available from Yaesu).



Figure 8.

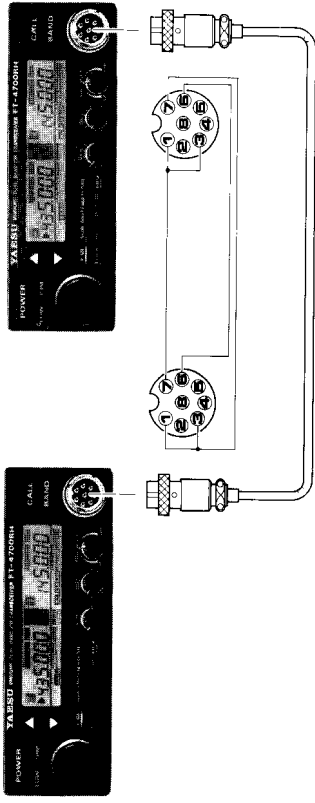

- (1) Turn both transceivers off, and then press and hold the F[M] buttons while turning the power switches on. The displays will be blinking.
- (2) Press the REV button on the destination transceiver (the display will stop blinking).
- (3) Press the RPT button on the source transceiver. When the data transfer is complete, the displays should return to normal. If "Err" is displayed, turn both transceivers off and try again.
- (4) Turn both transceivers off and remove the cloning cable.

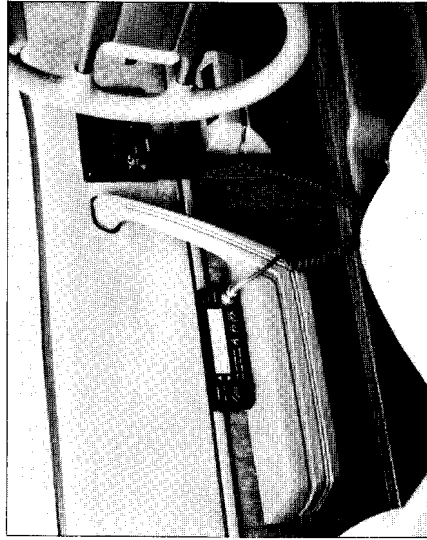

Figure 9.

OPERATION

This chapter describes all of the transceiver functions in detail. After studying these descriptions, keep the FT-4700RH Operator's Quick Reference Card handy in case you need to refresh your memory.

Preliminary Operating Information

Before operating the transceiver, recheck power supply and antenna connections. Never operate the transceiver on a band without an antenna connected for that band. Also, please read the earlier section on Controls & Connectors, if you have not already, to familiarize yourself with the functions of the controls.

Remember, references to alternate button functions have "[F]+" in front of the button name to remind you to press the F[M] button first momentarily, and then the named button within five seconds (while "FUNC" appears in the small shaded box at the top center of the display). Don't hold the F[M] button down, as that will give you a different result. When a button is to be held down, as opposed to just pressed momentarily, the instructions will so state.

If nothing happens when you press a button, the panel may be "locked" (you normally use this to prevent accidental changes). If you see "PANEL LOCK" displayed in a small box in the center of the display, press the LOCK button below and to the right of the main selector knob to unlock the panel. Later you can press the LOCK button again to fix your settings and prevent tampering.

One or more beeps will sound when a button is pressed, at a level determined by the volume control. In general, higher-pitched beeps indicate functions affecting the 70cm band, while lower-pitched beeps indicate functions affecting the 2m band.

If you have trouble getting the transceiver to work as described, see 'In Case of Problems' on page 38.

Squelch Setup

Before turning on the transceiver for the first time, set the VOL and SQL controls fully counterclockwise. Then press the POWER button and adjust the VOL control for a comfortable volume on the noise or received signal (on either band). "BUSY" should be displayed in reverse letters to the left of the S&PO meter scale. If a signal is present, rotate the selector knob until a frequency is found where only noise is heard.

Turn the SQL knob clockwise just to the point where the noise is silenced and "BUSY" disappears (if the SQL is set further clockwise, sensitivity to weak signals is reduced). Whenever a signal reaches the receiver that is strong enough to open the squelch, "BUSY" will be displayed.

If the transceiver has not been used before, the display will look something like this:

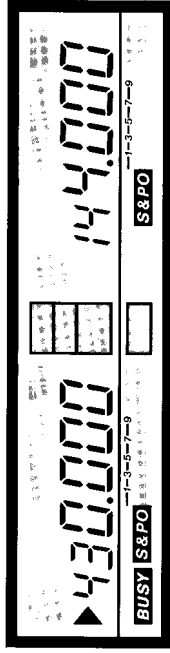

An arrowhead always appears to the left of one of the two frequency displays, indicating the primary band of operation. Also, bargraph segments appear in the S&PO box below the frequency on the display while receiving a signal, indicating received signal strength (and not affected by the squelch setting).

NOTE: If you see a small number or an "L", "U" or "C" in the shaded box above the arrowhead just mentioned, the transceiver is in the memory mode. Press the D/MR button (just to the left of the VOL knob) to switch to the Dial mode, which will be described first.

With those preliminaries out of the way, let's explore some of the main operating features.

Band Selection

Press the BAND button just above the MIC jack to select the desired primary operating band. The arrowhead to the left of one of the displayed frequencies will shift to the other band.

Frequency & Step Selection

After selecting the primary band, select the MHz range in which you wish to operate with the up/down arrow buttons. Press momentarily for a 1-MHz step, or hold an arrow button down for multiple steps.

When this display is within about 500 kHz of the frequency you want, use the selector knob to tune in fine steps. Normally the tuning step size will have been preset for your area, but if not, you can change the step size as described in the box below.

You can also use the UP/DWN keys on the microphone to select your operating frequency. However, if you press and hold one of these keys for more than $\frac{1}{2}$ -second scanning will start. This is described later, but if you've already tried it, just press a microphone key again to stop.

CHANNEL STEP SELECTION

Tuning steps are factory preset to the correct size for the country to which the FT-4700RH is exported. To change to another step size (5, 10, 12.5, 20 or 25 kHz) press [F]+REV and use the selector knob or microphone keys to select a different step (the step size is displayed at the right). The "5" or "P" at the left is the scan mode indicator, described later. Once the desired step size is displayed, press REV to return to the operating frequency display.

Dual Band Reception

The SUB key allows you to control the secondary band. During the above band and frequency selection procedures, you may have seen the secondary band frequency displayed, or you may have seen only "----". By pressing the SUB key you can choose to either display (and receive on) the secondary band, or to hide it and operate the FT-4700RH like a standard single band transceiver.

When both bands are displayed you can perform some operations on the secondary band (without having swap it to primary). For example, to set the secondary band's frequency just press [F]+SUB first so that a second arrowhead appears (blinking), and then use the up/down arrow keys and selector knob to tune as described above to change the frequency of the secondary band.

Most of the functions described in the following pages can be done on the secondary band as well as on the primary band, just by pressing [F]+SUB before starting the procedure, and then performing all steps within 5 seconds of each other (while the arrowhead is still blinking). However, the functions listed below disable the [F]+SUB selection of the secondary band while they are active:

- (a) Monoband operation (when "----" is displayed).
- (b) Channel step selection.
- (c) During Repeater offset and ARS setting.
- (d) During CTCSS Tone and Scan Mode setting.
- (e) While scanning.

Remember: just press [F]+SUB first to tune or perform a function (except while in the midst of doing one of the above) on the secondary band.

When the secondary band is displayed the receiver combines the received audio from both displayed frequencies, so you can listen for a call on one band while monitoring or working stations on the other band. Use the BALANCE control to adjust the relative audio levels of the two bands, if necessary, for equal volume after the VOL control has been set.

Selective Band Receiver Muting

If during dual band reception you want one band to take priority over the other (so signals from the two bands don't "double"), press the MUTE button: once to mute the secondary band, or twice to mute the primary band. "MUTE" is displayed above the MHz digits of the band on which it is enabled. Now whenever signals are received on both bands simultaneously, the MUTED band's audio will be suppressed by signals on the other band. However, when the unmuted band is quiet, the other will be heard at full volume.

Transmitting

Press the LOW button under the POWER switch to select 5-watt output ("LOW" appears in the shaded box at the bottom center of the display when low power is selected). When you wish to transmit, wait until the channel is clear ("BUSY" not displayed), and squeeze the PTT switch on the microphone. During transmission, the red "ON AIR" indicator at the upper right corner of the panel lights, and the S&PO bargraph for the transmitting band shows relative transmitter power output ("5" for low power, full-scale for high). Release the PTT switch to receive.

If more power is required, press the LOW button again. However, we recommend using low power whenever possible to minimize possible interference to other stations, current consumption and heating.

If using a version B (in Europe) press the BURST button on the MH-14A8 microphone to transmit a 1750 Hz Burst Tone to access repeaters that require it.

During dual band reception, you can transmit on the primary band without interrupting reception on the secondary band. This capability allows full duplex crossband operation if you and the station you are working are tuned to the same frequencies.

Repeater Splits

The FT-4700RH offers three methods to set up split frequency operation for repeaters: manual, automatic and independently stored transmit/receive frequencies. Both manual and automatic methods shift the transmit frequency above or below the receive frequency by a programmable offset, preset at the factory to 600 kHz for the 2m band, and either 1.6, 5 or 7.6 MHz on the 70cm band (depending on transceiver version). Note that only one offset at a time can be used on each band with the manual and automatic methods. Use the independent transmit frequency method when you want to store other offsets, such as frequencies of repeaters with non-standard splits. This will be described later under Separate Transmit Frequency Memories.

To manually activate the standard shift, just press the RPT key: once for minus shift, again for plus shift, and again to return to simplex. A small "-" or "+" sign will appear above the rightmost frequency digit when minus or plus shift is selected, respectively.

EXAMPLE: To operate through a repeater whose output frequency is 146.94 MHz, and whose input frequency is 146.34 MHz:

- (1) Tune the 2m display to 146.94 MHz (you will receive on the output frequency).
- (2) Press the RPT key once. A "-" should appear in the upper right corner of the display (if not keep pressing RPT until it does).
- (3) When the channel is clear, press the PTT switch on the microphone. The display should shift to 146.34 MHz while you transmit.

This example only works if the offset for 2m is set to 600 kHz, as supplied from the factory. If it is not, you can change it as described next.

Once repeater split is activated, you can temporarily reverse the transmit and receive frequencies by pressing the REV key. Use this to display the transmit frequency without transmitting, and to check the strength of signals on a repeater uplink frequency.

Setting Standard Repeater Offset

As just mentioned, the repeater offset is set at the factory to match the requirements of the country to which the FT-4700RH is exported. If you need to change the offset, do the following:

- (1) Select the band on which you want to change the repeater shift offset (each band has its own).
- (2) Press [F]+RPT to display the current offset. Standard repeater shift (in MHz, to three decimal places) appears at the right.
- (3) Use the up/down arrow keys (for 1 MHz steps) and the selector knob or mic UP/DWN buttons to select the desired offset.
- (4) Press the RPT key to return to the operating frequency display.

You will probably want to keep the repeater offset programmed to the most commonly used split in your area.

Automatic Repeater Shift

The ARS (Automatic Repeater Shift) feature in the FT-4700RH automatically activates repeater offset whenever you tune to a standard repeater subband (see diagram below). When this feature is enabled, a small "-" or "+" displayed above the rightmost frequency digit indicates that repeater shift is active, and closing the push-to-talk switch changes to the (shifted) transmit frequency.

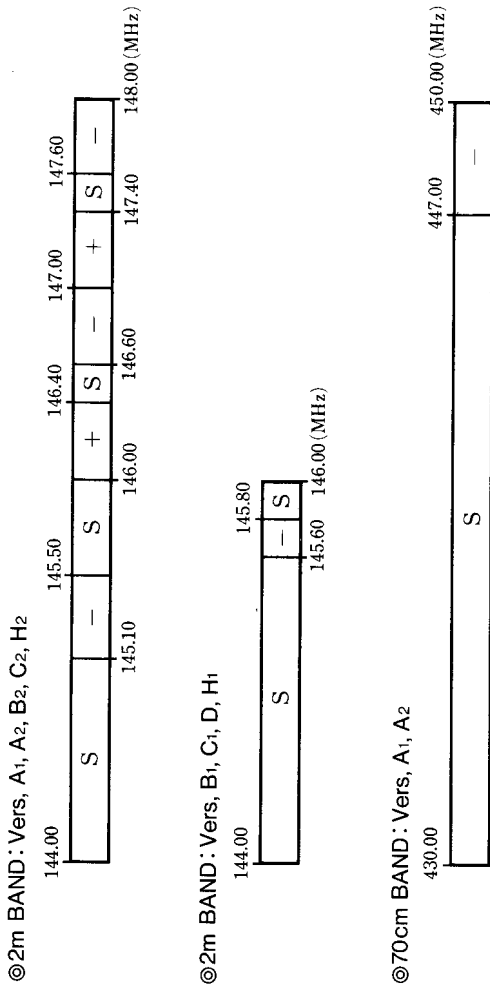

S : Simplex
 - : Minus Shift
 + : Plus Shift

The ARS function is disabled at the factory. To enable it:

- (1) Press [F]+RPT to display the ARS status (and repeater shift offset). If ARS is currently enabled, an "A" appears at the left.
- (2) Now press the F key to enable ARS. If no "A" was displayed, it should be now (pressing F again disables ARS).
- (3) Press RPT to return the display to the operating frequency.

Whether ARS is activated or not, you can still use the manual shift method (RPT key) at any time to select a new shift state, as already described. However, when ARS is activated, manual selections override ARS only until you change operating frequency.

Simple Memory Storage & Recall

The FT-4700RH offers twenty memories (10 on each band), labelled I through 7, C, L and U. Memories I through 4 and C can each store separate receive and transmit frequencies or repeater shift, and tone squelch data (if the optional FTS-8 is installed). All of the other memories can store everything except separate transmit frequencies. Memory C (the CALL channel memory) can be recalled instantly by the CALL button, and memories L and U and are used for programmable subband limits, described later, in addition to general purpose operation.

To store a frequency in memory:

- (1) Select the desired frequency (and repeater split manually, if desired) in the Dial mode as already described.
- (2) Press and hold the F key for ½-second. A memory label appears blinking in the shaded box at the upper left corner of the display for the selected band.
- (3) Within five seconds of step (2), use the selector knob or microphone UP/DWN keys to select the desired memory for storage. If you select one that was already being used, it will be overwritten with new data in the next step.
- (4) Press the F key momentarily to store the displayed data into the selected memory: the memory label will stop blinking for a second, and then disappear as operation continues in the Dial mode.

EXAMPLE: Store the 146.34/146.94 repeater data in memory 5.

- (1) First perform the steps in the example on page 26 to set up the desired frequency and offset on the dial.
- (2) Press and hold the F key for ½-second to display the memory label in the shaded memory box at the upper left corner of the 2m display- then do the next step within 5 seconds.
- (3) Turn the selector knob, if necessary, so that "5" shows in the memory box.

(4) Press F again, momentarily. That's it. The dial data has been stored in memory 5 for the 2m band, and you are left operating on the Dial.

To confirm that this worked, turn the selector knob to change the Dial frequency (to anything), and then press D/MR to change from Dial to memory mode. The numeral 5 should appear in the shaded memory box, and 146.94 (the receive frequency) should appear on the display. Press REV to confirm the transmit frequency of 146.34 MHz.

Our choice of using memory 5 in the above example was intentional, although you could have used almost any memory label with the same result (1-7, L or U: the C memory requires a different procedure). Memories 5 - 7 are typically used only for this type of storage (or for simplex channels, of course), while the others have additional applications which are described after the next section.

Recalling Memories

In confirming the results of the last example, we used the D/MR key to change from the Dial mode to the memories after they had been stored. The memory label is displayed in the shaded box at the upper right corner of the frequency display whenever operating on a memory.

When more than one memory has been stored, you can use the selector knob or the microphone UP/DWN buttons to select a memory for operation. If you use the microphone buttons, press and release the button for each memory: if you hold the button down for ½-second, memory scanning will start.

NOTE: The up and down arrow keys on the front panel CANNOT be used for memory selection. These have a different function in the memory mode (memory tuning activation), described later.

Alternating Band Memory Selection

If you want to select among memories on both bands, press [F]+BAND to activate ALternating Band Memory Selection. "AL." will be displayed in a shaded box at the center of the display, and memory selection will alternately select memories stored on each band, as pictured here:

ALTERNATE BAND MEMORY SCANNING

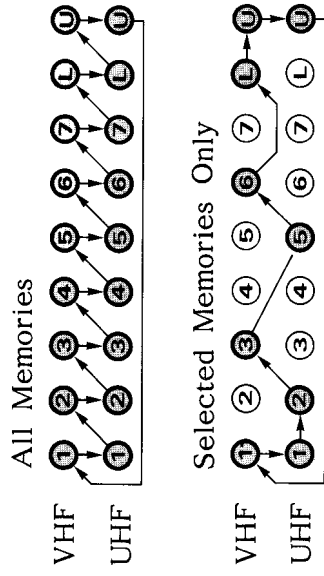

This feature can be especially convenient for memory scanning both bands, described later.

To cancel Alternating Band Memory Selection press the up or down arrow buttons on the front panel, the BAND button or D/MR key, or the CALL button (to jump to the CALL channel memory).

Call Channel Memory

Although invisible to the memory recall methods just described, the call channel memory can be instantly recalled by pressing the CALL button. "C" appears in the memory window at the upper left corner of the display. The factory default for the CALL channel memory is the bottom edge of the band, but you can reprogram it from the dial with any frequency and repeater state, or even a separate transmit frequency.

To store the current Dial frequency/repeater state in the CALL channel memory, press and hold the F key for ½-second to display the memory label box, and then press the CALL button. To store a separate transmit frequency in the call channel, after storing the receive frequency, tune the dial to the transmit frequency and repeat the above, but this time holding the PTT switch when you press the CALL button.

Separate Transmit Frequency Memories

As mentioned before, in addition to the CALL memory, memories 1 through 4 are capable of storing independent receive and transmit frequencies. To do this,

- (1) Store the receive frequency using the method already described under Simple Memory Storage (it doesn't matter if an offset is active).
- (2) Retune the Dial to the desired transmit frequency.
- (3) Press the F key for $\frac{1}{2}$ -second to display the memory label box again.
- (4) Hold the PTT switch while pressing F once more momentarily (the transmitter is not activated in this process).

Whenever a separate transmit frequency memory is recalled, "-+" appears at the upper right corner of the band display. Again, you can press the REV key to display the transmit frequency.

If you rewrite the receive frequency of a separate transmit frequency memory the separate transmit frequency will be cleared.

Memory Tuning

Memories 1 through 7 can be retuned once recalled, by first pressing the up or down arrow button momentarily. Nothing changes on the display, but you can now tune the displayed memory frequency in the same ways as described before (including the 1-MHz buttons). If you retune and want to store the new memory settings (in the current, or another memory), just follow steps (2) - (4) of the Simple Memory Storage procedure: operation will remain on the memory.

If you don't want to save your changes to the memory, just press D/MR: once to return to the original memory data, and press it again if you want to leave the memories and return to the Dial mode.

Hiding and Erasing Memories

As already mentioned, storing data in a memory automatically overwrites data that was previously stored there. However, if you regularly move

from one area to another, you may not want to use the same number of memories all the time, or you may wish to change your operating memories without having to rewrite them from scratch. This can be done by masking certain memories so that they are completely hidden from operation, and recalling them only when desired for operation.

To mask a memory,

- (1) Recall the memory to be masked.
- (2) Press the F key for $\frac{1}{2}$ -second (until the memory label blinks).
- (3) Press the REV key. This causes the display to change to memory 1, and the previously-selected memory is no longer selectable manually, or by scanning (as described later).

To unmask a hidden memory for operation,

- (1) Recall any memory.
- (2) Press the F key for $\frac{1}{2}$ -second.
- (3) Select the memory number to be restored.
- (4) Press the REV key.

Remember not to accidentally overwrite hidden memories. If you do, previous contents are lost.

Scanning

Before starting the scanner, make sure the SQL control is set to squelch off the noise on a clear channel. Scanning is activated and deactivated by the UP or DWN keys on the microphone. Just press and hold the key for more than $\frac{1}{2}$ -second to start the scanner. If the transceiver is in the Dial mode, band scanning will result. Otherwise, if a memory label is displayed, only the memories will be scanned (on both bands alternately if alternating band memory selection is active).

The scanner pauses whenever a signal is detected which is strong enough to open the squelch, and the decimal point on the display blinks. You have a choice of two scan-resume modes: either Pause mode, in which the scanner pauses for as long as the carrier keeps the squelch open, or

the 5-second mode, in which the scanner pauses for five seconds and then resumes scanning whether or not the signal is still present. The 5-second mode is the factory default.

To change the scan-resume mode, press [F]+REV. A small "P" or "5" at the left indicates the current mode. Press [F]+REV again to change it and return to the frequency display, or just press the REV key alone to return to the frequency display with no change in scan-resume mode.

You can stop the scanner manually by pressing the PTT, UP or DWN key on the microphone, or the D/MR button.

Memory Skip Scanning

When you have some very active channels stored in memories you may wish to skip them when scanning other memories, but still have them available for manual selection. You can mark a memory to be skipped by pressing [F]+D/MR while the memory is recalled. "◀SKIP" will be displayed just to the right of the memory number box, and this memory will be skipped during scanning (although you can still recall it manually). To unmask a scan-skip memory, just repeat the same steps you took to mask it: select the memory manually, and press [F]+D/MR.

Programmable Subband Limits

In addition to band and memory scanning, the FT-4700RH can be set to tune or scan only the frequencies between two subband limits of your choice. These limits are stored in the special memories labelled "L" and "U":

- (1) Store the lower edge of the desired scanning range in memory L, and the upper edge in memory U.
- (2) With either memory U or L recalled, press either the up or down arrow button on the transceiver.

You can now tune or scan as already described. If the either ARS or manual repeater shift is activated, repeater offset will be applied automatically when you transmit (even if the resulting transmit frequency is outside of the subband).

NOTE: The frequency resolution of subband limits is 100 kHz, although the channel resolution of memories L and U is finer than this (equal to the selected channel step size). Therefore the frequencies stored in memories L and U are rounded down to the nearest 100 kHz to determine the actual subband limits.

EXAMPLE: To limit reception to 146.0 to 148.0 MHz (only applicable to certain transceiver versions)

- (1) Tune the Dial to any channel between 146.000 and 146.095 MHz.
- (2) Hold the F key for ½-second, tune the selector knob so that "L" appears in the 2m memory box, and then press F again momentarily. The displayed frequency is now stored, providing an effective lower subband limit of 146.000 MHz.
- (3) Tune the Dial to any channel between 148.000 and 148.095 MHz.
- (4) Repeat step (2), selecting "U" in the memory box. This stores the effective upper subband limit of 148.000 MHz.
- (5) Press D/MR to change to memory operation.
- (6) Press and hold either the up or down arrow button on the transceiver for ½-second to activate the 146.000 - 148.000 subband limits for tuning and scanning.

To cancel your subband limits and return to memory operation, press D/MR (if you are scanning, you will have to press it twice). Pressing CALL will also cancel subband limits.

Once you have stored the L and U memories, you can reactivate the subband just by holding the up or down arrow button for ½-second. Of course you can also activate the subband when the L or U memories are marked for skip-scanning, but you CANNOT activate the subband if either of these memories are masked (hidden).

Priority Channel Monitoring

The Priority function allows automatic checking for activity on a memory every five seconds while operating on the Dial or other memories. When the receiver detects a signal on the priority memory, operation automatically shifts to that memory for as long as a carrier is received.

Tone Squelch Operation

The FT-4700RH can be used to access CTCSS-activated stations and repeaters, and to silently monitor for calls on busy channels when the optional FTS-8 Tone Squelch Unit is installed (one must be installed for each band on which CTCSS is to be used). The encode function of the FTS-8 superimposes a subaudible tone (at a frequency too low to be heard) on the transmitted carrier, while the decode function monitors receiver audio through a narrow filter at the same subaudible frequency, keeping the squelch closed until a matching tone is received. Installation instructions for the FTS-8 are in the 'Installation' section of this manual.

To check or set the CTCSS tone frequency, press [F]+TONE. The tone frequency will be displayed (in Hz), with a leading zero if that tone selection is a high-Q type. To change the tone frequency, rotate the selector knob or press the microphone DWN/UP keys until the display shows the tone frequency you require (the display will step through the standard EIA tones, plus 97.4 Hz). Press TONE to return to the operating frequency display when the tone frequency is selected.

To activate tone squelch (if an FTS-8 is installed for the band) press TONE. 'ENC' (encode) will be displayed and the tone generator will be activated for transmission. Press TONE again and both 'ENC' and 'DEC' (decode) will be displayed together as tone squelch is activated for both transmission and reception (a matching tone frequency will open the squelch). Pressing TONE once more disables tone squelch features.

Once you have the tone squelch set up the way you want it, you can store it in any memory. Afterwards, to change a memory, just recall it, repeat the tone frequency or function, and store the memory again.

FTS-8 CTCSS TONE FREQUENCIES

This data is significant only if the optional FTS-8 Tone Squelch Unit is installed.

CTCSS TONE FREQUENCY (Hz)						
67.0	100.0	123.0	151.4	186.2	233.6	C77.0
71.9	103.5	127.3	156.7	192.8	241.8	C79.7
77.0	107.2	131.8	162.2	203.5	250.3	C82.5
82.5	110.9	136.5	167.9	210.7	267.0	C85.4
88.5	114.8	141.3	173.8	218.1	271.9	C88.5
94.8	118.8	146.2	179.9	225.7	274.4	C91.5

If you transmit while paused on the priority memory, priority monitoring is cancelled and operation stays on the priority memory. To set up for priority monitoring:

- (1) Preset the squelch, and store the frequency to be monitored in a memory (this MUST be memory 1 if you will be operating on other memories during priority monitoring).
- (2) Press D/MR to operate in the Dial mode, or else select the memory you want to operate on, and then press [F]+MUTE(PRI). A 'P' will appear in the memory window at the upper left corner of the display, and about every five seconds the displayed frequency will shift to the priority memory briefly while the receiver checks for a signal.

As long as no signal appears on the priority memory to open the squelch, you can tune, transmit and receive on the Dial, or select (but NOT scan) and operate on other memories. If a station you wish to talk with appears on the priority memory, press the PTT switch momentarily while receiving his signal, to stop priority checking. Otherwise, when a signal appears on the priority memory the scanner will pause and the decimal on the display will blink; then priority monitoring will resume (according to how you set the scan resume mode - either after a 5-second pause, or after the carrier drops). To cancel priority monitoring manually, press D/MR.

Note that you can use any other memory as a priority channel in the above procedure when operation is to be on the Dial. You cannot, however, switch from memory to Dial operation or vice-versa without first cancelling priority monitoring (since pressing D/MR cancels priority monitoring). You also cannot scan on the same band during priority monitoring. You can, however, operate on the other band in any way you please.

Scan Stop Beeper Disable

You may have noticed a beep in the loudspeaker when the scanner stops or the priority channel is checked. This beep can be alternately disabled and re-enabled by pressing [F]+DIM.

In Case of Problems

Basic FT-4700RH operation is not complicated, but it is still possible to get lost, at least until you have had the chance to learn the various functions of the keypad and display. If the display shows nothing at all, check the power switch, and the power supply connections.

The symbols on the display tell a lot (but not all) about the current state of operation, as long as power is applied, so it is well worthwhile to study the display diagram on page 6 carefully. For example, if the frequency display changes unexpectedly when you transmit (or if 'Err' appears), check for a small '+' or '-' near the upper right. Also, if only a few seemingly non-sensical digits appear, press TONE to disable the tone squelch setting feature.

If pressing a key appears to do nothing, first check for "PANEL LOCK" at the center of the display. If you see it, press the LOCK key to unlock the keys. Otherwise, press D/MR, which will terminate any partially entered commands. If you still cannot enter data, check to see if the red "ON AIR" indicator at the upper right of the panel is on, indicating that the transceiver is transmitting. Releasing the PTT switch should return the set to receive. If still nothing happens, switch the transceiver off, and then back on.

To avoid confusion resulting from inadvertent key presses, set the keypad lock on (press LOCK) if you leave the transceiver unattended while it is on, and then remember to set the lock back off when you wish to enter data.

As a last resort, if you are unable to gain sensible control of the transceiver, reset the CPU:

Resetting the CPU

Resetting the CPU clears all memories, repeater shifts and other settings to their defaults, and leaves the transceiver cpu in the same state as when it left the factory. To reset the CPU, switch off the transceiver and remove the front panel (if not using the YSK-4700 Trunk Mounting Kit). Gently press a sharp tool in the hole in the rear of the Front Panel/Controller, indicated in the diagram on the next page.

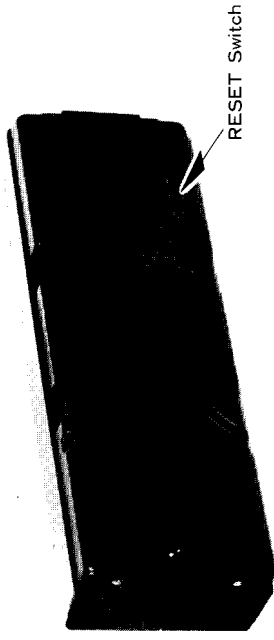

Memory Backup

Normally, a lithium battery inside the transceiver retains all settings and memories while power is off or disconnected. However, if these batteries ever needs replacing, the transceiver will be found to have lost its memories. The location of the battery is shown in the photo below, but it should be replaced only by an Yaesu-authorized technician to ensure that it is instal.

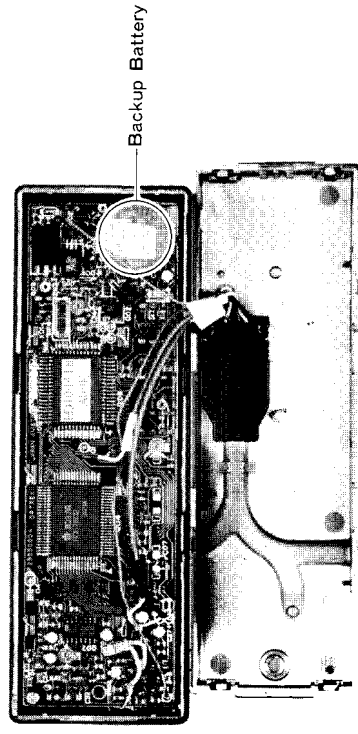

Front Panel Disassemble

