



KENWOOD

SERVICE MANUAL

Model TR-2300



2m FM HANDY TRANSCEIVER

CONTENTS

GENERAL	3
CIRCUIT DESCRIPTION	3
DATA	4
PARTS ALIGNMENT	9
PRINTED CIRCUIT BOARD	11
RX SYNTHESIZER UNIT (X55-1220-61)	11
TX UNIT (X56-1280-00)	12
FILTER UNIT (X51-1160-00)	12
TONE UNIT (X52-1110-61)	12
PARTS LIST	13
PACKING	16
DISASSEMBLY	17
TROUBLE SHOOTING	18
LEVEL DIAGRAM	22
ADJUSTMENT	24
OPTION/ACCESSORY	29
TRICKLE CHARGER (BC-1)	29
NICKEL-CADMIUM BATTERY PACK (PB-15)	29
HELICAL WHIP ANTENNA (RA-1)	29
BLOCK DIAGRAM	30
SCHEMATIC DIAGRAM	31
SPECIFICATIONS	32

GENERAL/CIRCUIT DESCRIPTION

GENERAL

The TR-2300 is an all solid state 144 MHz band handy transceiver for amateur radio stations, small in size and thickness, and light in weight with a transmitting output power of 1 W. The MODE is FM. The PLL frequency synthesizer system assures transmission and reception on 80 channels, separated 25 kHz apart from one another, which may be selected by a combination of the rotary switch which has 40 positions per turn.

CIRCUIT DESCRIPTION

Units

RX SYNTHESIZER unit:	X55-1220-61
TX unit:	X56-1280-00
FILTER unit:	X51-1160-00
TONE unit:	X52-1110-61 (W type)
	X52-1110-50 (T type)

Both the TX and RX units have many accessory circuits and terminals to perform various functions.

Accessory Circuits

- (1) S. RF meter
- (2) Battery checker
- (3) Squelch circuit
- (4) Aux circuit
- (5) TONE OSC circuit
- (6) (CHANNEL, AUX, ON AIR) Lamp indicator circuit
- (7) Frequency shift circuit (Repeater)

Accessory Terminals

- (1) Whip antenna terminal: For connecting whip and helical antenna provided as accessories.
- (2) External antenna terminal: For connecting external antenna.
- (3) MIC terminal: For connecting microphone
- (4) External DC terminal: For connecting external power supply or nickel-cadmium battery charger
- (5) External speaker terminal: For connecting earphone or external speaker

Receiver Circuit

Received signals are amplified by RF amplifier Q1, from which the amplified signals are applied to the first mixer Q2. The receiver has two tuning circuits in its antenna circuit, and a helical resonator after the RF amplifier to obtain the required bandwidth. This design is effective for rejecting undesired out-of band waves, and cross modulation (2-signal) characteristics. Examples of sensitivity suppression and intermodulation characteristics are shown on Page 8.

The first oscillator's output signal on the 133 MHz band is applied from the PLL circuit to the first mixer, from which the 1st intermediate frequency of 10.7 MHz is taken out. The first IF signal runs through MCF to Q3, which amplifies it and sends the amplified signal to Q4. Q4 has a limiter circuit, 10,245 MHz second oscillator circuit, mixer circuit, discrete circuit, and a squelch circuit built into it. (See Page 4.) Q4 produces an AF signal from its Pin 9, and sends it to Q5, which amplifies it and sends the amplified signal to Q16 (TX unit) for AF power amplification.

Part of the second intermediate frequency is fed to Q6 and Q7, where it is amplified for operating the S meter. An input of about 10 μ V (20 dB μ) is necessary for the meter to indicate S-8.

Transmitter Circuit

Audio signals from the MIC terminal are amplified by Q9 to the level required for modulation. Q1 is a crystal oscillator circuit, which generates a 10.7 MHz signal. The audio signals are used for variable reactance direct shift.

The signal amplified by Q2 is mixed with the 133 MHz band signal from the PLL circuit by the balanced mixer which consists of Q3 and Q4 into a 144 MHz band signal. The signal then passes the band pass filter consisting of L5, L6, and L7 to Q5 and Q6, where it is amplified. The amplified signal then goes to Q7 for power amplification. Part of the drive output from Q6 is rectified by D3 and D4, whose output is sent to Q8, where it is amplified. A stable transmitting output is produced by applying ALC to Q5.

PLL Circuit

Fig. 1 shows the basic composition of the PLL circuit. The PLL circuit is designed on the basis of the PLL circuit for the TR-7500, but consumes much less power and occupies much less space. VCO assures satisfactory frequency and output stability by use of FETs, temperature compensation and power stabilizing. The output of VCO is converted into an IF signal of 3.60 to 4.575 MHz by the output (129.6999 MHz) of the local oscillator in the mixer. The local oscillator is a 3rd overtone 43,2333 MHz crystal oscillator, whose output is tripled into 129.6999 MHz. The IF signal is amplified, and divided into one half by a pre-scaler into a signal of 1.80 to 2.2875 MHz, which is then applied to the programmable divider C-MOS LSI.

The frequency dividing ratio (N) of the programmable divider is set at somewhere between 144 and 183 (Table 1) with the main knob so that its output will always be 12.5 kHz. The output of the reference oscillator (12.80 MHz) is divided by 1 024 by the frequency divider into a 12.5 kHz signal, which is applied to the phase comparator, where it is compared with the output of the programmable divider. The comparator output is applied from a low pass filter to

DATA

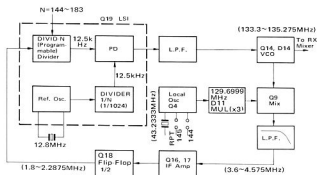

Fig. 1 PLL Circuit

the variable capacitor VCO to control its frequency. The VCO output is buffer-amplified into a transceiver local oscillator signal.

The frequency dividing-ratio (N) is fixed at 128 for the AUX channels. Thus the local oscillator's crystal oscillation frequency (f_0) is so determined that an intermediate frequency of 1.60 MHz will be applied to the programmable divider. Therefore, f_0 will be:

$$f_0 = \frac{f - 13.90}{3} \quad (\text{MHz})$$

where f is the receiving frequency.

In the following case, the PLL circuit is unlocked and the buffer amplifier Q13 stops operating, making it impossible to transmit or receive.

1. This position is selected without connecting crystal oscillators to the AUX channels.
2. The main knob (40 CH) is anywhere between channel positions.
3. The PLL circuit has failed.

SEMICONDUCTOR DATA

[MC3357]

Circuit Description

The MC3357 is a low-power FM IF circuit designed for in voice communication scanning receivers.

An input frequency (10.7 MHz) to Pin 16 is down to 455 kHz signal by OSC and mixer. This signal runs through an external band pass filtering back to Pin 5 for limiter amplification.

The audio is recovered using conventional quadrature FM detector circuit. IF noise is heard at this time, it means that there are no input signals. This noise band is monitor-

Table 1 Programmable Cord

Indication	N	P7 128	P6 64	P5 32	P4 16	P3 8	P2 4	P1 2	P0 1
AUX	128	1	0	0	0	0	0	0	0
00	144	1	0	0	1	0	0	0	0
•	145	1	0	0	1	0	0	0	1
05	146	1	0	0	1	0	0	1	0
•	147	1	0	0	1	0	0	1	1
90	180	1	0	1	1	0	1	0	0
•	181	1	0	1	1	0	1	0	1
95	182	1	0	1	1	0	1	1	0
•	183	1	0	1	1	0	1	1	1

ed by an active filter and a detector.

A squelch trigger circuit's scan control output also shows whether or not there is noise. Simultaneously, the internal switch operates to cancel the audio output (from terminal 9). OSC is an internal bias Colpitts type oscillator, whose collector (Pin 4), base (Pin 1) and emitter (Pin 2) are connected. A crystal is used instead of an ordinary coil. The mixer is doubly balanced type for reducing spurious response. Pin 16's input impedance is kept low by an internal bias resistance of 3 k Ω , and the mixer output is connected to a crystal filter.

Pin 3 is connected to +B.

The signal passes through a band pass filter (ceramic or LC) to a 5-stage limiter amplifier circuit (Pin 5), and the limiter output from Pin 7 directly drives, or externally drives through a quadrature coil, the multiplier circuit in circuit in the IC for FM detection.

The output from Pin 7 is also used for DC feedback to Pin 5.

The demodulated audio signal runs through a filter and buffer so that Pin 9's impedance will be about 400 Ω .

This signal runs via the deemphasis circuit, volume control circuit and amplifier circuit to drive the speaker. Pin 11 produces a simple inverting OP amplifier output for externally applying a DC bias to Pin 10. Internally, there is a 2 V bias. The filter is composed of external impedance elements for frequency discrimination.

The audio signal through the filter is fed to an external AM detecting circuit, which checks the presence or absence of noise or tone signals on the audio band.

This output enters Pin 12.

The external positive bias input to Pin 12 sets the squelch trigger circuit so that Pin 13's impedance will be low at about 60 k Ω . Then the audio mute circuit (Pin 14) opens.

If the voltage of Pin 12 reaches 0.7 V due to noise of the tone detector, the voltage of Pin 13 rises to a level 0.5 V below the source voltage, applying a load current of

DATA

about 500 μ A. Pin 14 is internally grounded.

Pin 12 has a hysteresis of 100 mV for preventing jitter. Audio muting is accomplished by connecting Pin 14 to a high-impedance reference grounding point in the audio path between Pin 5 and the audio amplifier.

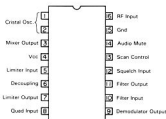

Fig. 2 MC3357 Pin Arrangement

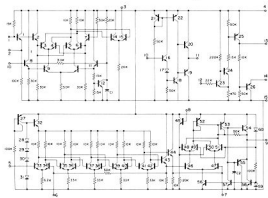

Fig. 3 MC3357 Equivalent Circuit

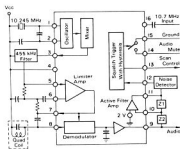

Fig. 4 MC3357 Block Diagram

[SM5104GA]

Circuit Description

This product was developed as a C-MOS LSI for PLL, and consists of an OSC (reference oscillator circuit), DIVIDER (reference frequency divider), AMP (amplifier circuit), PC (programmable counter), and PD (phase detector) as shown in the block diagram.

A high-accuracy crystal oscillator circuit can be formed by adding a crystal resonator and a capacitor between Q_{IN} and Q_{OUT} of the reference oscillator circuit. External signals can be applied to Q_{IN} at the same time.

The oscillator output is sent to the reference divider circuit, where the input is divided into the required frequency. The divided frequency serves as reference signal f_r for the digital type phase detector located downstream. The reference divider circuit can be set at a dividing ratio of either 1/1024 or 1/2048 by means of F_5 (frequency division selecting terminal). The comparison signal (f_i) applied to input terminal F_{IN} of the amplifier is amplified and shaped before it is sent to the programmable counter, where it is converted into f_{pc} by program terminals P_0 through P_7 (if $P_0 \dots P_7 = 1$, for example, the programmable counter produces an output of 1/255). The converted frequency f_{pc} is led to the phase detector.

The phase detector compares the phase of this signal with that of the reference signal, and produces a pulse length signal in direct proportion to the phase difference between the two signals, such as shown in Fig. 5, from its output terminal D_0 .

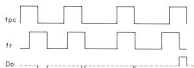
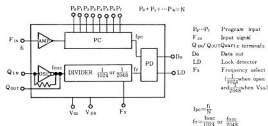

Fig. 5



Note: Pull down resistors are set in terminals $P_2 \dots P_7$.

Pull up resistor is set in terminal F_5 .

Fig. 6 SM5104GA Block Diagram

DATA

Table 2 SM5104GA Absolute Maximum Ratings

Item	Code	Rating	Unit
Power supply voltage	V _{DD} -V _{SS}	-0.3~+7.0	V
Operating voltage	V _{DD} -V _{SS}	+4.5~+5.5	V
Input voltage	V _{IN}	V _{SS} ≤ V _{IN} ≤ V _{DD}	V
Operating temperature	T _{OPR}	-30~+70	°C
Storage temperature	T _{STR}	-40~+125	°C
Power consumption	P _W	250	mW
Soldering consumption		260	°C
Soldering time		5	sec

Table 3 SM5104GA Program Counter Truth Table

SM5104 GA	N	P ₇	P ₆	P ₅	P ₄	P ₃	P ₂	P ₁	P ₀	
	1	0	0	0	0	0	0	0	0	1
	2	0	0	0	0	0	0	0	1	0
	3	0	0	0	0	0	0	0	1	1
	•	•	•	•	•	•	•	•	•	•
	•	•	•	•	•	•	•	•	•	•
	128	1	0	0	0	0	0	0	0	0
	•	•	•	•	•	•	•	•	•	•
	•	•	•	•	•	•	•	•	•	•
	255	1	1	1	1	1	1	1	1	1

$f_{out} = \frac{1}{N} f_{in}$ '1' -High level, '0' -Low level

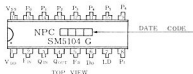

Fig. 7 SM5104GA Pin Arrangement

CRYSTAL QUARTZ (AUX Channel)

1. Type: HC-25/μ
2. Frequency:

$$f_0 = \frac{f - 13.90}{3} \quad (\text{MHz})$$

f = desired frequency

f₀ = The oscillation frequency to be obtained

3. Allowable frequency deviation:
+20 X 10⁻⁶ or less (at 25°C)
-10 X 10⁻⁶ or less (at 25°C)
4. Temperature range and allowable deviation:
±30 X 10⁻⁶ (-20 to +60°C)
5. Oscillator circuit and output (Fig. 9)
6. Oscillator output is more than 0.13 V (rms) when the following circuit is used as an experiment circuit.

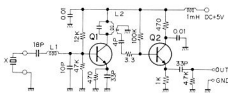

- L1: L33 0605-05
- L2: L32 0607-05
- Q1, 2: 25C460 (B)

Fig. 9 OSC Circuit

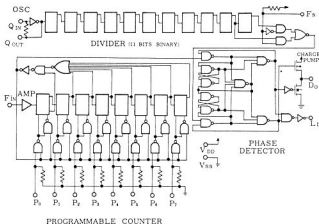

Fig. 8 SM5104GA Equivalent Circuit

DATA

2SC2329 (Final Transistor)

Table 6 Specifications

Application	VHF band power amplifier					
SPS Epitaxial phase type						
Collector voltage	1.8 V					
Emitter voltage	3.0 V					
Collector emitter voltage	1.8 V					
IC	0.15 mA					
Test base	PE (T _a = 25°C) 1.5 W Storage temperature T _{stg} = 17.5 °C T _{stg} = 8.5 ~ 11.5 °C					
Function temperature	T _{stg} = 17.5 °C					
Storage temperature	T _{stg} = 8.5 ~ 11.5 °C					
Test condition	T _{stg} = 25°C					
Item	Code	Condition	Min.	Typ	Max.	Unit
Collector cut-off current	IC80	V _{CE} = 2.0V, I _B = 0	—	—	0.25	nA
Positive cut-off current	IE80	V _{BE} = 2V, I _C = 0	—	—	0.25	nA
DC amplifier factor	β _{DC}	V _{CE} = 10V, I _B = 0.2A, f = 0.5 kHz	—	60	200	—
Collector capacity	C _{ob}	V _{CE} = 10V, I _B = 0, f = 1.0 MHz	—	7	10	pF
Output power	P _{out}	V _{CE} = 12.5V, I _B = 234.5mA, f = 173.5kHz	23	24	—	dBm
Collector efficiency	η _c	—	55	70	—	%

UPC575C2

Table 7 Specifications

Application	2.0W AF amplifier				
Construction	Semiconducting IC				
Power supply voltage	V _{CC1} (No signal input) 24.0 V				
Power supply voltage	V _{CC2} (Distortion) 17.0 V				
Circuit current	I _c 1.0 A				
Packaged loss	P _{loss} W				
Operating temperature	T _{op} -20 ~ +75 °C				
Storage temperature	T _{stg} -40 ~ +150 °C				
Test condition	T _a = 25°C				
Test condition	T _a = 25°C V _{CC} = 13.2V F = 1kHz P _o = 40				
Item	Code	Min.	Typ	Max.	Unit
Static drain current	I _{CC}	V _{in} = 0	8	12	mA
Output power	P _o	T _a = 25°C	1.5	2.0	W
Voltage gain	A _V	F _o = 0.5W	31	30	dB
Total harmonic distortion	THD	P _o = 0.5W	—	0.5	1.5 %
Output noise voltage	V _n	R _g = 10	—	0.4	0.8 mV

Table 4 Maximum Ratings of MC3357 (T_a = 25 °C, unless otherwise noted)

Rating	Pin	Symbol	Value	Unit
Power Supply Voltage	4	V _{CC(max)}	12	V
Operating Supply Voltage Range	4	V _{CC}	4 to 8	V
Emitter Inlet Voltage	8	V _{EE}	1.0	V
Input Voltage (V _{CC} > 4.0 V)	14	V _{in}	1.0	V
Input Voltage (V _{CC} > 4.0 V)	14	V _{in}	-0.5 to 0.5	V
Junction Temperature	—	T _j	150	°C
Operating Ambient Temperature Range	—	T _a	-20 to +70	°C
Storage Temperature Range	—	T _{stg}	-40 to +150	°C

Table 5 Electrical Characteristics of MC3357

Characteristics	Pin	Min	Typ	Max	Unit
Drain Current Off	4	—	2.0	—	mA
Search On	—	—	2.0	5.0	—
Search Off	—	—	2.0	—	—
Input Impedance	16	—	10	—	Ω
Input Impedance (1.5 dB rolloff)	—	—	3.0	—	—
Director Output Voltage	9	—	2.0	—	V
Director Output Impedance	—	—	400	—	Ω
Measured Audio Output Voltage	8	200	380	—	mV rms
Frequency (10 mV)	—	—	—	—	—
Frequency (5 mV)	—	—	—	—	—
Frequency (3 mV)	—	—	—	—	—
Filter Output Voltage	15	1.8	2.0	2.5	V
Trigger Resistance	—	—	100	—	mΩ
Main Function Low	14	—	15	50	Ω
Main Function High	14	1.0	10	—	Ω
Stop Function Low (Main Off)	13	—	0	0.5	V
Stop Function High (Main On)	13	—	0	—	—
Stop Function High (Main On) (V _{CC} = 7.0V)	—	—	0.0	—	—
Main Gain/Phase Gain	3	—	20	—	dB
Main Input Resistance	16	—	2.0	—	Ω
Main Input Capacitance	16	—	2.2	—	pF

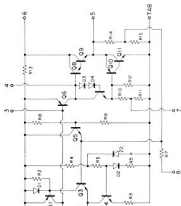
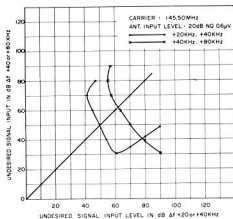

Fig. 10 μPC575C2 Equivalent Circuit

FILTER (L72-0309-05)

Nominal center frequency:	455 kHz
3 dB bandwidth:	More than ± 5 kHz (from 455 kHz)
6 dB bandwidth:	More than ± 7.5 kHz (from 455 kHz)
60 dB bandwidth:	Less than ± 16 kHz (from 455 kHz)
Guaranteed attenuation:	
	More than 45 dB at 455 ± 100 kHz
	More than 30 dB at 0.1 to 1.0 MHz
Ripple:	Less than 3 dB at 455 ± 5 kHz
Insertion loss:	Less than 6 dB
Input and output impedance:	1.5 k Ω



Intermodulation Characteristics

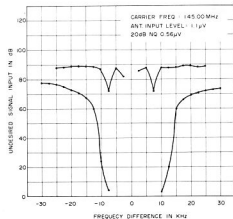

Sensitivity Suppression Characteristics

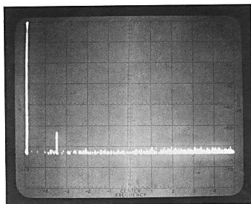

NOTE:
 * CARRIER FREQ.: 145.5 MHz
 * RF POWER: 1.25 W
 * SCAN WIDTH: 100 MHz/DIV
 * BAND WIDTH: 30 kHz
 * SCAN TIME: 2 SEC
 * VIDEO FILTER: 10 kHz
 * INPUT ATT.: 20 dB
 * LOG REF LEVEL: -12 dBm
 10 dB/DIV

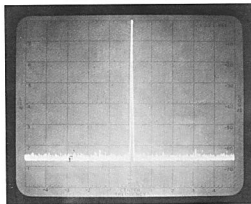

NOTE:
 * CARRIER FREQ.: 145.5 MHz
 * RF POWER: 1.25 W
 * SCAN WIDTH: 2 MHz/DIV
 * BAND WIDTH: 30 kHz
 * SCAN TIME: 0.1 SEC
 * VIDEO FILTER: 10 kHz
 * INPUT ATT.: 20 dB
 * LOG REF LEVEL: -12 dBm
 10 dB/DIV

Spurious Response

PARTS ALIGNMENT

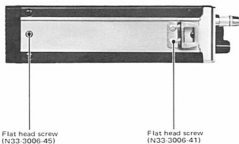
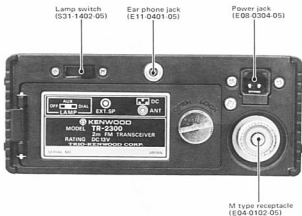
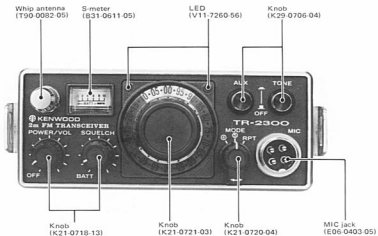

PARTS ALIGNMENT

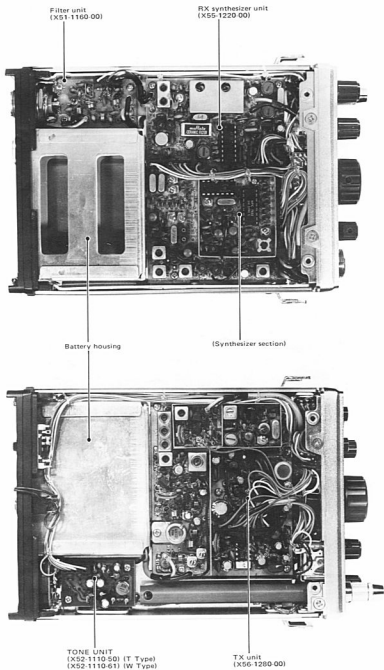

PRINTED CIRCUIT BOARD

▼ RX - SYNTHESIZER UNIT (X55-1220-61)

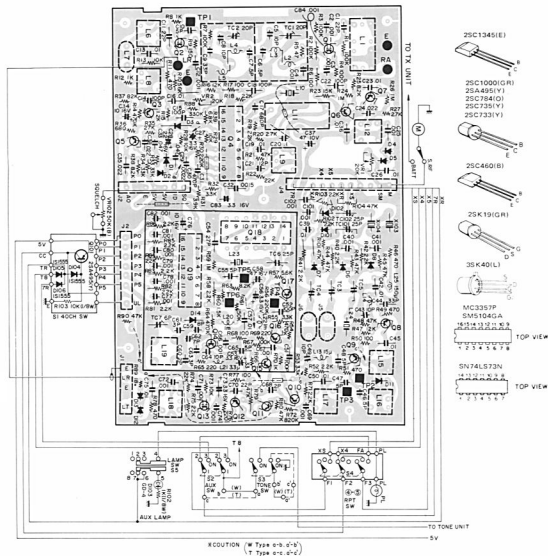

Q1, 2, 13 3K40(L), Q3, 8, 16, 17 2SC460(B), O4 MC3357P, O5 2SC1000(IGR), O6, 7: 2SA495(Y), O9, 10, 15 2SC784(O),
 O11 2SC733(Y), O12 2SC1345(E), Q14 2SK19(IGR), O18 SN74LS73N, Q19 SM5104GA, D1, 2, 4, 5: 1N60,
 O3, 9, 10 1S1555, D6, 7, 8, 12, 13 1S2588, D11 1S516, D14 1S2208

2SC1345(E)



2SC1000(IGR)



2SC784(O)



2SC733(Y)



2SC460(B)



2SK19(IGR)



3SK40(L)



MC3357P

SM5104GA

16-114 12 11 10 9

1 2 3 4 5 6 7 8

TOP VIEW

SN74LS73N

14-11 12 11 9 8

1 2 3 4 5 6 7

TOP VIEW

PRINTED CIRCUIT BOARD

▼ TX UNIT (X56-1280-00)

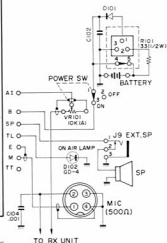
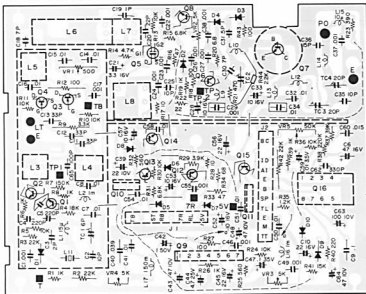

Q1, 2-2SC460(B), Q3, 4-2SK19(GR), Q5-3SK40(L), Q6-2SC2407, Q7-2SC2329, Q8, 15-2SC458(B), Q9- TA7061AP, Q10 μ PC78L08, Q11 μ PC78L05, Q12-2SC735(Y), Q13-2SA562(Y), Q14-2SC496(Y), Q16 μ PC575C2-B, D1: 1S2208, D2, 5, 7, 9, 10: 1S1555, D3, 4: 1N60, D8- XZ-088

2SC1345(E)



2SC735(Y)
2SA562(Y)



2SC460(B)



2SC496(Y)

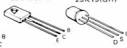

2SK19(GR)



3SK40(L)



2SC2329



2SC2407



TA7061AP



μ PC575C2-B



μ PC78L08
 μ PC78L05



1 IN
2 OUT
3 GND

▼ FILTER UNIT (X51-1160-00)

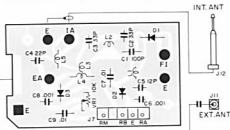

D1: M1301, D2: 1S2588, D3: 1N60

▼ TONE UNIT (X52-1110-51) T TYPE

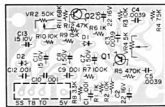

PARTS LIST

TOTAL * Symbol: New parts

Ref. No.	Parts No.	Description	Re- marks
CAPACITOR			
C101	CC45L2H330J	Ceramic 33pF ±5%	
C102, 103	CK45F1H103Z	Ceramic 0.01μF +80%, -20%	
C104	CK45B1H102K	Ceramic 1000pF ±10%	
RESISTOR			
R101	RC05GF2H330J	Solid 33Ω ±5% 1/2W	
R102	RC14BB2B471J	Carbon 470Ω ±5% 1/8W	
SEMICONDUCTOR			
D101	V11-0219-05	Diode V06B	
D102, 103	V11-7260-56	LED GD-4-203SRD	*
POTENTIOMETER			
VR101, 56	R05-3401-05	Variable resistor 10kΩ(A) VOL. POWER	*
VR102, 57	R05-4401-05	Variable resistor 50kΩ(B) SQU. METER	*
SWITCH			
S1	S29-1402-05	Rotary switch CHANNEL	*
S2, 3	S40-2403-05	Push switch 20 kHz CALL	*
S4	S29-1401-05	Rotary switch (Ⓢ, Ⓣ) - RPT	*
S5	S31-1402-05	Slide switch LAMP	*
MISCELLANEOUS			
J8	E08-0304-05	Power jack	
J9	E11-0401-05	Earphone jack	
J10	E06-0403-05	4P mic jack	
J11	E04-0102-05	M type receptacle	
—	A01-0723-03	Case (Top)	*
—	A01-0724-03	Case (Bottom)	*
—	A20-2327-05	Panel	*
—	A21-0721-04	Ornamental panel (W)	*
—	A21-0720-04	Ornamental panel (T)	*
—	A23-1425-03	Rear panel ass'y	*
—	B01-0613-03	Escutcheon (Right)	*
—	B01-0614-03	Escutcheon (Left)	*
—	B05-0706-04	Speaker grill cloth	*
—	B19-0602-04	Dial slit	*
—	B30-0106-05	Pilot lamp (Small)	*
—	B31-0611-05	S meter	*
—	B40-2444-04	Name plate (W)	*
—	B40-2443-04	Name plate (T)	*
—	B50-2576-00	Operating manual (W)	*
—	B50-2600-00	Operating manual (T)	*
—	B41-0610-00	Name plate (Caution)	*
—	B42-1641-04	Name plate (EXT. SP)	*
—	D21-0806-04	Shaft	*
—	E12-0001-05	Phone plug (Supplied)	*
—	E20-0481-03	4P terminal plate (for battery)	*
—	E23-0015-04	Earth lug x 6	*
—	E23-0043-04	Antenna earth lug x 2	*
—	E23-0097-04	Terminal (for J12)	*
—	E30-0220-05	Power plug with lead wire (3P)	*
—	E31-0428-05	Lead wire A for TX filter	*
—	E31-0429-05	Lead wire B for whip antenna	*
—	F07-0820-05	Cover	*
—	F20-0510-04	Insulating plate x 2	*
—	F29-0403-04	Antenna insulating pipe	*
—	G11-0008-04	Cushion (for meter)	*
—	G13-0614-04	Cushion (for upper case)	*
—	H01-2575-03	Carton case (Inside) (T)	*

Ref. No.	Parts No.	Description	Re- marks
—	H01-2576-03	Carton case (Inside) (W)	*
—	H03-1667-04	Carton case (Outside) (T)	*
—	H03-1670-04	Carton case (Outside) (W)	*
—	H10-2506-01	Packing material foamed styrene	*
—	H10-2507-04	Packing material (Plates)	*
—	H25-0079-04	Polyethylene bag (Microphone)	*
—	H25-0112-04	Polyethylene bag (TR-2300)	*
—	H25-0116-04	Polyethylene bag (Hook metal fitting, screw, plug)	*
—	H25-0120-04	Polyethylene bag (Power cord, belt, battery case, dummy)	*
—	J19-0461-05	Battery case (A) (supplied)	*
—	J19-0462-05	Battery case (B) (supplied)	*
—	J19-1310-04	Diode holder x 2	*
—	J19-1312-04	Band fittings x 2	*
—	J20-0319-24	Hook fittings (supplied)	*
—	J25-2601-04	PC board (A) (for channel SW)	*
—	J25-2602-04	PC board (B) (for Ⓢ, Ⓣ - RPT SW)	*
J12	J32-0230-04	Antenna mounting bracket	*
—	J32-0718-04	Antenna holder	*
—	J42-0401-04	Knob bushing x 2	*
—	J61-0055-05	Shouldering belt	*
—	K21-0708-13	Knob x 2 (VOLUME, SQU)	*
—	K21-0720-04	Knob (Ⓢ, Ⓣ) - RPT	*
—	K21-0721-03	Knob (CHANNEL)	*
—	K29-0706-04	Knob x 2 (PUSH SW)	*
—	N08-0501-04	Ornamental screw	*
—	N09-0256-05	Screw (GN)	*
—	N14-0116-04	Hex. boss (for J12)	*
—	N14-0507-04	Hex. boss x 3 (VR101, 102, 54)	*
—	N19-0282-04	Washer (for J12)	*
—	N19-0283-04	Insulating ring (for J12)	*
—	N19-0604-04	Spacer (for cover)	*
—	N19-0605-04	Washer (for channel knob)	*
—	N24-3015-41	E ring x 2	*
—	T07-0202-05	Speaker 0.5W/8Ω	*
—	T90-0082-05	Antenna	*
—	T91-0032-15	Microphone (supplied)	*
—	W09-0002-05	Dummy battery	*
—	W09-0004-05	Trickle charger (T)	*
—	W09-0005-05	Trickle charger (W)	*
—	E29-0511-05	Socket pin	*
—	E40-1068-05	Pin socket	*
—	E40-0768-05	Pin socket	*
—	E40-0668-05	Pin socket	*
—	E40-0468-05	Pin socket	*

FILTER UNIT (X51-1160-00)

CAPACITOR			
C1	CC45L1H101J	Ceramic 100pF ±5%	
C2, 3	CC45L1H330J	Ceramic 33pF ±5%	
C4	CC45L1H220J	Ceramic 22pF ±5%	
C5	CC45CH1H120J	Ceramic 12pF ±5%	
C6	CK45B1H102K	Ceramic 1000pF ±10%	
C7	CK45F1H103Z	Ceramic 0.01μF +80%, -20%	
C8	CK45B1H102K	Ceramic 1000pF ±10%	
C9	CK45F1H103Z	Ceramic 0.01μF +80%, -20%	
SEMICONDUCTOR			
D1	V11-0255-05	Diode M301	
D2	V11-0414-05	Diode 1S2588	
D3	V11-0051-05	Diode 1N60	
POTENTIOMETER			
VR1	R12-3405-05	Semi-fixed resistor (10K)	

PARTS LIST

Ref. No.	Parts No.	Description	Re- marks
L1	L34-0692-05	VHF coil	
L2, 3	L34-0693-05	VHF coil	
L4	L34-0690-05	VHF coil	☆
L5	L34-0499-05	VHF coil	

TONE UNIT (X52-1110-50) (T TYPE)
(X52-1110-61) (W TYPE)

CAPACITOR			
C1	CK45B1H102K	Ceramic 1000pF	±10%
C2	CE04W1C2200	Electrolytic 22μF	16WV
C3-5	C91-0433-05	Layer-built 0.0039μF	±5%
C6	CE04W1C2200	Electrolytic 22μF	16WV
C7, 8	CE04W1H010	Electrolytic 1μF	50WV
C9, 10	CK45B1H102K	Ceramic 1000pF	±10%
C11	CS15E1A150K	Tantalum 15μF	±10%
C12	CK45B1H102K	Ceramic 1000pF	±10%
C13	CS15E1A150K	Tantalum 15μF	±10%
RESISTOR			
R1-12	RD14CB2E000J	Carbon 000Ω	±5% 1/4W
	Bul		
R2, 3	R92-0616-05	Metal film 10kΩ	±1% 1/4W
R4	R92-0617-05	Metal film 7.5kΩ	±1% 1/4W
R5	RN14BK2E4700F	Metal film 470kΩ	±1% 1/4W
R10	RD14CB2E102J	Carbon 15kΩ	±5% 1/4W
SEMICONDUCTOR			
Q1, 2		Transistor 2SC458 (B)	
D1, 2		Diode 1S1555	(T)
D1		Diode 1S1555	(W)
POTENTIOMETER			
VR1	R12-2405-05	Semi-fixed resistor 5kΩ	☆
VR2	R12-4403-05	Semi-fixed resistor 50kΩ	(T)☆
MISCELLANEOUS			
-	E40-0464-05	Pin plug	

RX SYNTHESIZER UNIT (X55-1220-61)

CAPACITOR			
C1	CC45SL1H220J	Ceramic 22pF	±5%
C2-4	CK45B1H471K	Ceramic 470pF	±10%
C5	CC45CH1H100D	Ceramic 10pF	+0.5pF
C6, 7	CC45CH1HR5C	Ceramic 0.5pF	+0.25pF
C8	CC45CH1H100D	Ceramic 10pF	+0.5pF
C9	CC45SL1H330J	Ceramic 33pF	±5%
C10	CC45CH1HR5C	Ceramic 0.5pF	+0.25pF
C11	CC45CH1H220J	Ceramic 22pF	±5%
C12	CK45B1H102K	Ceramic 1000pF	±10%
C13	CK45F1H103Z	Ceramic 0.01μF	+80%, -20%
C14, 15	CC45SL1H101J	Ceramic 100pF	±5%
C16	CK45F1H103Z	Ceramic 0.01μF	+80%, -20%
C17	CK45B1H681K	Ceramic 680pF	±10%
C18	CC45SL1H101K	Ceramic 100pF	±5%
C19, 20	C91-0433-05	Layer-built 0.1μF	±10%
C21	CC45CH1H120J	Ceramic 12pF	±5%
C22	CC45SL1H101J	Ceramic 100pF	±5%
C23	C092M1H103K	Mylar 0.01μF	±10%
C24	C91-0426-05	Layer-built 0.022μF	±10%
C25	CK45B1H102K	Ceramic 1000pF	±10%
C26	CK45F1H103Z	Ceramic 0.01μF	+80%, -20%
C27	CS15E1C3R3M	Tantalum 3.3μF	16WV
C28	CS15E1C2R2M	Tantalum 2.2μF	16WV
C29	C91-0430-05	Layer-built 0.047μF	±10%

Ref. No.	Parts No.	Description	Re- marks
C30	C092M1H222K	Mylar 2200pF	±10%
C31	CK45B1H471K	Ceramic 470pF	±10%
C32	CK45B1H152K	Ceramic 1500pF	±10%
C33	C91-0430-05	Layer-built 0.047μF	±10%
C34	CE04W1C100	Electrolytic 10μF	16WV
C35	C092M1H222K	Mylar 0.022μF	±10%
C36	CK45F1H103Z	Ceramic 0.01μF	+80%, -20%
C37	CE04W1A470	Electrolytic 47μF	10WV
C38	C91-0426-05	Layer-built 0.022μF	±10%
C40, 41	CK45B1H102K	Ceramic 1000pF	±10%
C42	CK45F1H103Z	Ceramic 0.01μF	+80%, -20%
C43	CC45CH1H100D	Ceramic 10pF	+0.5pF
C44	CC45CH1H330J	Ceramic 33pF	±5%
C45	CK45F1H103Z	Ceramic 0.01μF	+80%, -20%
C46, 47	CC45CH1H050D	Ceramic 5pF	+0.5pF
C48	CC45CH1H270J	Ceramic 27pF	±5%
C49	CC45CH1H100D	Ceramic 10pF	+0.5pF
C50	CK45F1H103Z	Ceramic 0.01μF	+80%, -20%
C51, 52	CC45SL1H101J	Ceramic 100pF	±5%
C53	CS15E1C3R3M	Tantalum 3.3μF	16WV
C54	CC45CH1H270J	Ceramic 27pF	±5%
C55	CC45CH1H050D	Ceramic 5pF	+0.5pF
C56	CS15E1C3R3M	Tantalum 3.3μF	16WV
C57	C90-0246-05	Ceramic 0.01μF	±10%
C58	CS15E1C4R7M	Tantalum 4.7μF	16WV
C59	CC45TH1H080D	Ceramic 8pF	+0.5pF
C60	CC45TH1H020C	Ceramic 2pF	+0.5pF
C61	CC45TH1H030C	Ceramic 3pF	+0.25pF
C62	CC45RH1H070D	Ceramic 7pF	+0.5pF
C63	CC45CH1H030C	Ceramic 3pF	+0.25pF
C64	CC45CH1H100D	Ceramic 10pF	+0.5pF
C65	CC45CH1H050D	Ceramic 5pF	+0.5pF
C66, 67	CK45B1H102K	Ceramic 1000pF	±10%
C68	CC45CH1H020C	Ceramic 2pF	+0.25pF
C69	CK45B1H102K	Ceramic 1000pF	±10%
C70	CC45SL1H220J	Ceramic 22pF	±5%
C71, 72	CK45B1H102K	Ceramic 1000pF	±10%
C73	CS15E1C3R3M	Tantalum 3.3μF	16WV
C74	CK45B1H102K	Ceramic 1000pF	±10%
C75	CK45F1H103Z	Ceramic 0.01μF	+80%, -20%
C76	CE04W1C100	Electrolytic 10μF	16WV
C77-82	CK45B1H102K	Ceramic 1000pF	±10%
C83	CS15E1C3R3M	Tantalum 3.3μF	16WV
C84, 85	CK45B1H102K	Ceramic 1000pF	±10%
C101, 102	CK45B1H102K	Ceramic 1000pF	±10%
RESISTOR			
R1-104	RD14CB2E000J	Carbon 000Ω	±5% 1/4W
SEMICONDUCTOR			
Q1, 2	V09-0081-05	FET	35K40(L)
Q3	V03-0079-05	Transistor	25C460(B)
Q4	V30-1003-36	IC	MC3357F
Q5	V03-0355-05	Transistor	25C1000(GR)
Q6, 7	V01-0037-05	Transistor	25A495(Y)
Q8	V03-0079-05	Transistor	25C460(B)
Q9, 10	V03-0368-05	Transistor	25C784(O)
Q11	V03-0183-05	Transistor	25C733(Y)
Q12	V03-0271-05	Transistor	25C1345(E)
Q13	V09-0081-05	FET	35K40(L)
Q14	V09-0012-05	FET	25K19(GR)
Q15	V03-0368-05	Transistor	25C784(O)
Q16, 17	V03-0079-05	Transistor	25C460(B)
Q18	V30-1005-57	IC	SN74LS73N
Q19	V30-1002-36	IC	SM5104GA
Q20	V03-0241-05	Transistor	25C735(Y)
D1, 2	V11-0051-05	Diode	1N60
D3	V11-0076-05	Diode	1S1555
D4, 5	V11-0051-05	Diode	1N60
D6-8	V11-0414-05	Diode	1S2588

PARTS LIST

Ref. No.	Parts No.	Description	Re- marks	Ref. No.	Parts No.	Description	Re- marks
D9, 10	V11 0076-05	Diode 151555		C26, 27	CK45B1H102K	Ceramic 1000pF ± 10%	
D11	V11 0374-05	Diode 155116		C28	CE04W1C100	Electrolytic 10μF 16WV	
D12, 13	V11 0414-05	Diode 152588		C29	C90 0804-05	1000pF	
D14	V11 0317-05	Diode 152208		C30	CC45CH1H070D	Ceramic 7pF ± 0.5pF	
D101, 102	V11 0414-05	Diode 152588		C31	CC45CH1H0R5C	Ceramic 0.5pF ± 0.25pF	
POTENTIOMETER/TRIMMER				C32	C092M1H103K	Mylar 0.01μF ± 10%	
VR1, 2	R12-3407-05	Semi-fixed resistor 20kΩ	o	C33	CE04W1C100	Electrolytic 10μF 16WV	
TC1, 2	C05 0030-15	Ceramic trimmer 20pF		C34	C90 0804-05	Ceramic 1000pF	
TC3-6	C05 0067-05	Ceramic trimmer 25pF		C35	CC45CH1H100D	Ceramic 10pF ± 0.5pF	
TC7	C05 0062-05	Ceramic trimmer 6pF		C36	CC45CH1H150J	Ceramic 15pF ± 5%	
TC101, 102	C05 0067-05	Ceramic trimmer 25pF		C37, 38	CK45B1H102K	Ceramic 1000pF ± 10%	
COIL/INDUCTOR/IFT/CRYSTAL/FILTER				C39	CE04W1C220Q	Electrolytic 22μF 16WV	
L1	L34 0681-05	Tuning coil	o	C40	C092M1H393K	Mylar 0.039μF ± 10%	
L2	L34 0685-05	VHF coil	o	C41	C092M1H103K	Mylar 0.01μF ± 10%	
L3	L34 0684-05	VHF coil	o	C42	CE04W1H010	Electrolytic 1μF 50WV	
L4	L34 0686-05	VHF coil	o	C43	CE04W1A470Q	Electrolytic 47μF 10WV	
L5	L34 0687-05	VHF coil	o	C44	CE04W1E4R7	Electrolytic 4.7μF 25WV	
L6	L30 0289-05	IFT for 10.7MHz		C45	CE04W1C220Q	Electrolytic 22μF 16WV	
L7	L71 0201-05	Monolithic filter 10F15A		C46	CK45B1H102K	Ceramic 1000pF ± 10%	
L8	L30 0289-05	IFT for 10.7MHz		C47	CS15E1V0R1M	Tantalum 0.1μF 35WV	
L9	L30 0503-05	IFT for DET		C48	CE04W1A470Q	Electrolytic 47μF 10WV	
L10	L77 0327-05	Crystal quartz 10.245MHz		C49	CK45B1H102K	Ceramic 1000pF ± 10%	
L11	L72 0309-05	Ceramic filter CFT455F2	o	C50, 51	CK45F1H103Z	Ceramic 0.01μF +80%,-20%	
L12	L30 0199-05	IFT for 455MHz		C52, 53	CE04W1C100	Electrolytic 10μF 16WV	
L13	L40 1501-03	Ferri-inductor 15μH		C54	CK45F1H103Z	Ceramic 0.01μF +80%,-20%	
L14	L33 0605-05	Choke coil 0.47μH		C55	CK45B1H102K	Ceramic 1000pF ± 10%	
L15	L32 0607-05	OSC coil 40MHz		C56	CE04W1C221Q	Electrolytic 220μF 16WV	o
L16, 17	L34 0683-05	Tuning coil for 130MHz		C57	CE04W1C100	Electrolytic 10μF 16WV	
L18	L34 0682-05	Tuning coil for 130MHz AMP		C58	CK45F1H103Z	Ceramic 0.01μF +80%,-20%	
L19	L32 0606-05	OSC coil for VCO	o	C59	CS15E1V0R1M	Tantalum 0.1μF ± 20%	
L20	L40 1021-03	Ferri-inductor 1mH		C60	C092M1H153K	Mylar 0.015μF ± 10%	
L21	L40 3391-03	Ferri-inductor 3.3μH		C61	CE04W1C470Q	Electrolytic 47μF 16WV	
L22	L40 1021-03	Ferri-inductor 1mH		C62	CK45B1H331K	Ceramic 330pF ± 10%	
L33	L77 0758-05	Crystal quartz 12.8 MHz		C63	CE04W1A101Q	Electrolytic 100μF 10WV	
L34	L77 0821-05	Crystal quartz 43.3666MHz (RPT)	o	C64	CE04W1A470Q	Electrolytic 47μF 10WV	o
X103	L77 0819-05	43.2333MHz (144MHz)					
X104	L77 0820-05	43.5666MHz (145MHz)					
MISCELLANEOUS							
-	E18 0251-05	Crystal socket x 2	o				
-	E23 0046-04	Terminal (Square) x 6					
-	E23 0401-05	Terminal (Round) x 4					
-	F07 0821-04	Shield cover for helical	o				
-	F11 0724-04	Shield case for PLL	o				
-	F11 0725-04	Shield case for helical	o				
TX UNIT (X56-1280-00)							
CAPACITOR							
C1	CK45B1H102K	Ceramic 1000pF ± 10%					
C2	CC45TH1H100D	Ceramic 10pF ± 0.5pF					
C3	CC45U1J0G20C	Ceramic 2pF ± 0.25pF					
C4, 5	C91 0432-05	Condenser 220pF ± 10%	o				
C6	CC45L1H220J	Ceramic 22pF ± 5%					
C7, 8	CK45F1H103Z	Ceramic 0.01μF ± 80%,-20%					
C9	C092M1H104K	Mylar 0.1μF ± 10%					
C10	CE04W1C220Q	Electrolytic 22μF 16WV	o				
C11-13	CC45CH1H330J	Ceramic 33pF ± 5%					
C14-16	CK45F1H103Z	Ceramic 0.01μF ± 80%,-20%					
C17	CK45B1H102K	Ceramic 1000pF ± 10%					
C18	CC45CH1H070D	Ceramic 7pF ± 0.5pF					
C19	CC45CH1H010J	Ceramic 1pF ± 0.25pF					
C20	CC45CH1H220J	Ceramic 22pF ± 5%					
C21	CS15E1C3R3M	Tantalum 3.3pF 16WV					
C22-24	CK45B1H102K	Ceramic 1000pF ± 10%					
C25	CC45CH1H100Q	Ceramic 10pF ± 0.5pF					
R1-43	RD14CB2E000J but	Carbon ○○○○ ± 5% 1/4W					
R9	RD14BB2E33ZJ	Carbon 3.3kΩ ± 5% 1/4W					
R12	RD14BB2E101J	Carbon 100Ω ± 5% 1/4W					
R42	RD14BB2E22ZJ	Carbon 22kΩ ± 5% 1/4W					
R44	RD14BB2E22ZJ	Carbon 2.2kΩ ± 5% 1/4W					
SEMICONDUCTOR							
Q1, 2	V03 0079-05	Transistor 25C460(B)					
Q3, 4	V09 0012-05	FET 25K19(GR)					
Q5	V09 0081-05	FET 35K40(L)					
Q6	V03 2407-06	Transistor 25C2407	o				
Q7	V03 2329-06	Transistor 25C2329	o				
Q8	V03 0093-05	Transistor 25C458(B)					
Q9	V30 0039-05	IC TA7061AP					
Q10	V30 1030-16	IC μPC78L08	o				
Q11	V30 1029-16	IC μPC78L05	o				
Q12	V03 0241-05	Transistor 25C735(Y)					
Q13	V01 0032-05	Transistor 25A962(Y)					
Q14	V03 0336-05	Transistor 25C496(Y)					
Q15	V03 0093-05	Transistor 25C458(B)					
Q16	V30 1028-16	IC μPC575C2-B	o				
D1	V11 0317-05	Diode 152208					
D2	V11 0076-05	Diode 151555					
D3, 4	V11 0051-05	Diode 1N60					
D6	V11 0076-05	Diode 151555					
D7	V11 4163-46	Zener diode XZ 080	o				
D8	V11 0076-05	Diode 151555					
D9, 10	V11 4163-56	Zener diode XZ 088	o				
		Diode 151555					
POTENTIOMETER/TRIMMER							
VR1	R12-0042-05	Semi-fixed resistor 500Ω					

PARTS LIST/PACKING

Ref. No.	Parts No.	Description	Remarks	Ref. No.	Parts No.	Description	Remarks
VR2	R12 2015-05	Semi-fixed resistor 5K	○	L10	L34-0692-05	VHF coil	○
VR3, 4	R12 2403-05	Semi-fixed resistor 5K		L11	L77-0710-05	Crystal quartz 10.715MHz	
VR5	R12 4016-05	Semi-fixed resistor 50K		L12	L34-0691-05	VHF coil	
TC2	C05 0062-05	Ceramic trimmer 6P	○	L13	L34-0641-05	VHF coil	○
TC3	C05 0031-15	Ceramic trimmer 10P		L14	L34-0693-05	VHF coil	
TC3, 4	C05 0030-15	Ceramic trimmer 20P		L15	L40-1001-03	Ferri-inductor 10μH	
COIL/INDUCTOR/IFT/CRYSTAL				MISCELLANEOUS			
L1	L33 0615-05	Choke coil 15μH	○	—	E23-0046-04	Terminal (Square) x 6	○
L2	L40-1021-03	Ferri-inductor 1mH		—	E23-0401-05	Terminal (Round) x 4	
L3	L30 0005-05	IFT		—	E40-0764-05	Pin plug 7P	
L4	L31-0313-05	Tuning coil		—	E40-1064-05	Pin plug 10P	
L5	L34-0689-05	Tuning coil for Mix		—	F02 0413-05	Heat sink	
L6	L34-0688-05	Tuning coil 3 set		—	F10-1219-04	Shield plate	
L7	L34-0690-05	Tuning coil for 145MHz		—	F11-0726-04	Shield case	
L8	L34-0672-05	Tuning coil for 145MHz		—			
L9	L34-0641-05	VHF coil		—			

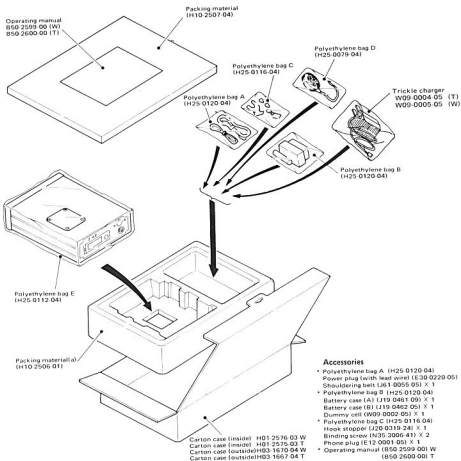

DISASSEMBLY

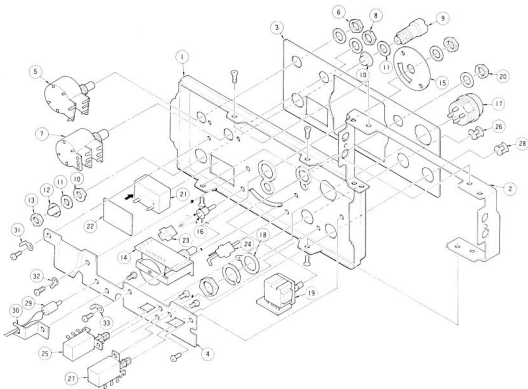

No.	Description	Parts No.	Remarks	No.	Description	Parts No.	Remarks
1	Panel	A20-2327-05		18	Antenna earth lug	E23-0043-04	
2	Panel mount fitting	A21-2567-03		19	Rotary switch	S29-2402-05	(A) (S) PRT
3	Ornamental panel	A21-0721-04(W) A21-0720-04(T)		20	Hex. nut	N14-0507-04	
4	Switch mount fitting	J21-2565-04		21	S-meter	B31-0611-05	
5	Potentiometer	R05-3401-05	POWER VOL	22	Cushion of meter	G11-0008-04	
6	Hex. boss	N14-0507-04		23	Diode holder	J19-1310-04	
7	Potentiometer	R05-4401-05	SQUELCH	24	Diode holder	J19-1310-04	
8	Hex. boss	N14-0507-04		25	Push switch	S40-2403-05	
9	Antenna stopper	J32-0230-04		26	Knob bush	J42-0401-04	
10	Insulator ring	N19-0283-04		27	Push switch	S40-2406-05(W) S40-2403-05(T)	STONE
11	Washer	N19-0282-04		28	Knob bush	J42-0401-04	
12	Terminal	E23-0007-04		29	Pilot lamp (small)	B30-0106-05	
13	Hex. nut	N14-0116-04		30	Lamp stopper	J21-2512-04	
14	Rotary switch	S29-1402-05	CHANNEL	31	Earth lug	E23-0015-04	
15	Dial slit	B19-0602-04		32	Earth lug	E23-0015-04	
16	LED	V11-7260-56		33	Earth lug	E23-0015-04	
17	4P MIC jack	E06-0403-05					

DISASSEMBLY/TROUBLE SHOOTING

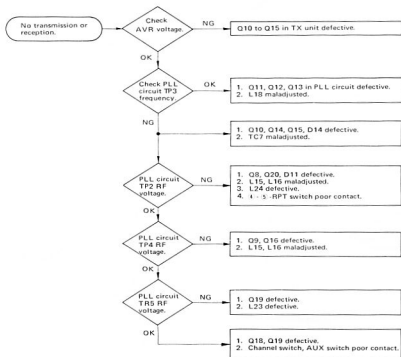
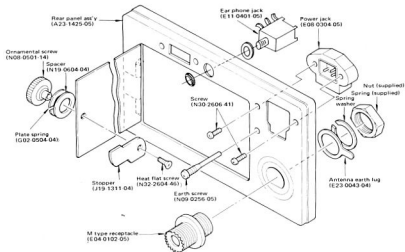

TROUBLE SHOOTING

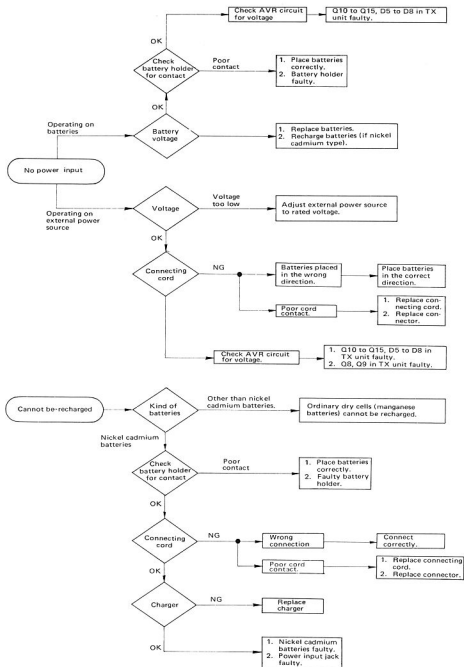

TROUBLE SHOOTING

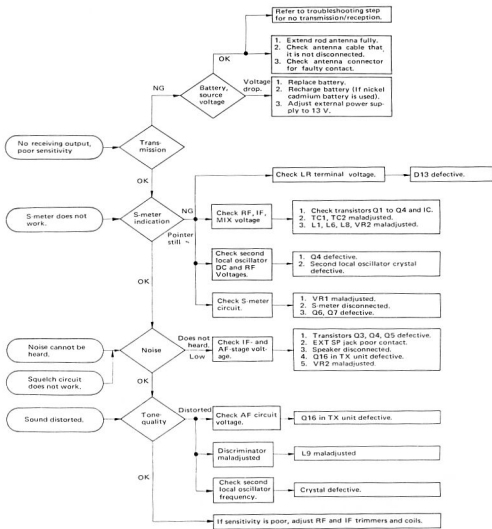

TROUBLE SHOOTING

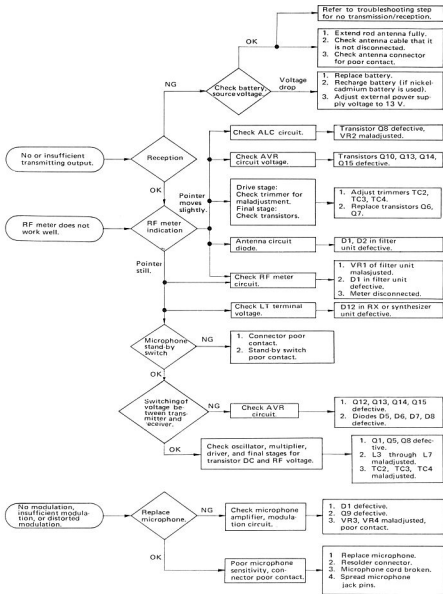

LEVEL DIAGRAM

RECEIVER SECTION

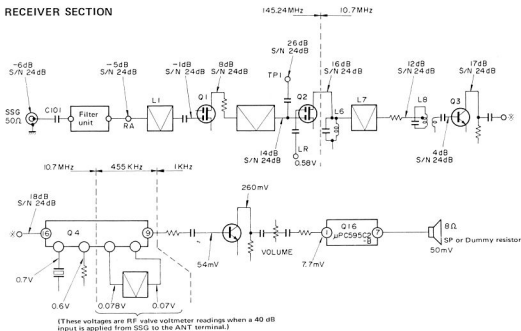

• Measuring Conditions

1. $C = 0.01\mu\text{F}$ (10 $\mu\text{F}/16\text{V}$ for AF circuit)
2. $f = 145.25\text{ MHz}$
 $\text{MOD} = 1\text{ kHz}$, $\text{DEV} = 5\text{ kHz}$
 $\text{AG} \quad f = 1\text{ kHz}$
3. Output: 50 mW/8 ohms

• Test Equipment

1. SSG: MG518A (Anritsu)
2. AG: AG-201 (Trio)
3. AF valve voltmeter: VT-106 (Trio)
4. RF valve voltmeter: ML69A (Anritsu)

SYNTHESIZER (PLL) SECTION

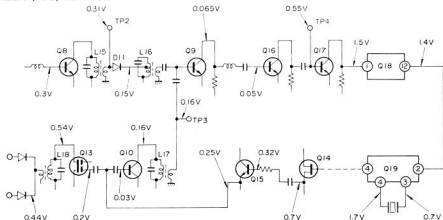

RF voltmeter: ML69A (Anritsu)

LEVEL DIAGRAM

TRANSMITTER SECTION

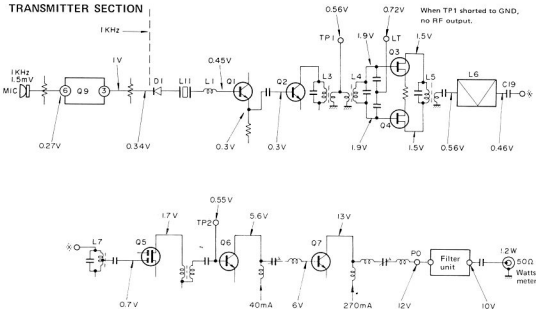

* Test Equipment and Measuring Conditions

- $f = 145.25$ MHz
- AG: AG-201 (Trio)
- AF valve voltmeter: VT-106 (Trio)
- RF valve voltmeter: ML69A (Anritsu)

TEST EQUIPMENT REQUIRED

1. **RF Valve Voltmeter**
 - Input impedance: $1\text{M}\Omega$ min., 20 pF max.
 - Voltage range: F.S. = 10 mV to 300 V
 - Measuring frequencies: 200 MHz min.
2. **Power Meter**
 - Impedance: $50\ \Omega$
 - Measuring range: 2 W
 - Measuring frequencies: 150 MHz min.
3. **DC Power Supply**
 - Voltage: Variable from 9 V to 16 V
 - Current: 1 A min.
4. **Linear Detector**
5. **Directional Coupler**
6. **Oscilloscope**
 - With horizontal input terminal and high sensitivity.
7. **Audio Voltmeter**
 - Measuring frequency: 50 Hz to 10 kHz
 - Input impedance: More than $1\text{M}\Omega$
 - Voltage range: F.S. = 3 mV to 30 V
8. **AF Oscillator**
 - Frequency range: 300 Hz to 5 kHz
 - Output: 0.5 mV to 1 V
9. **Frequency Counter**
 - Minimum input sensitivity: About 50 mV
 - Measuring frequency: 150 MHz min.
10. **Sweep Generator**
 - Frequency range: Capable of covering $144 \sim 148$ MHz
 - Measuring output: 145 MHz band
11. **Detector**
12. **SSG**
 - Capable of covering $144 \sim 148$ MHz
 - Frequency modulation is possible.
13. **DC Voltmeter**
 - Input impedance: Sufficient
14. **Dummy Resistor**
 - $8\ \Omega$, 5 W (approx.)

ADJUSTMENT

BEFORE ADJUSTMENTS AND REPAIRS

If you are making adjustments or repairs for the first time, or if you are not familiar with the proper way of handling the transceiver, read the instruction manual first before attempting adjustments or repairs. It is necessary to keep the following in mind.

Power Cord Conductors

The yellow wire of the accessory power cord is positive, the black one a grounding wire, and the red one for recharging. Be careful not to connect them in the wrong way.

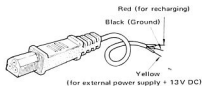

Fig. 11 Power Cord Conductors

Adjusting Tools

- When adjusting the trimmers or coils, use a non-inducted adjusting rod of bakelite or the like.
- This transceiver uses small-sized, semi-fixed variable resistors. Use a regular screwdriver of the size which matches the adjusting holes.

1. VOLTAGE AND LAMP OPERATION CHECKS

1. Terminal Voltage Check

- Turn the (4)-(5)-RPT knob to Position (5).
- Set the transceiver ready for reception, and check the following terminal voltages.
 - 5 V = 4.8 V to 5.2 V
 - 7 V = 7.0 to 7.6 V
 - T8 = 0 V
- Set the transceiver ready for transmission, and check the following terminal voltages and also check that the ON AIR lamp lights.
 - T8 = 7.7 to 8.3 V
 - 5 V = 4.8 to 5.2 V
 - 7R = Less than 0.5 V

2. Lamp Indication Check

- Check that the lamp goes out when the lamp switch is at OFF; that the Aux. indicator lights when the switch is at Aux., and that the channel lamp lights when it is at the lamp position.

3. Battery Checker Adjustment

- Turn the squelch knob counterclockwise all the way to the BATT position. Adjust the source voltage to 9.6 V.
- Turn VR5 in the TX unit until the S-meter pointer is between the red and black zones as shown in Fig. 12.



Fig. 12 Battery Check

2. PLL CIRCUIT

1. PLL Circuit Adjustment

- Set the transceiver ready for reception, turn the (4)-(5)-RPT knob to (5), and the Aux. knob to OFF. Turn the channel knob to position "00".
- Check the RF voltage at TP2, turn the L5 core clockwise 180° (half quarter turn) from the oscillation start point. (Reference voltage level at TP2: Approx. 0.35 Vrms)
- Connect the RF valve voltmeter to TP4, and adjust L16 and L17 repeatedly a few times until the meter reads maximum. (Reference voltage at TP4: Approx. 0.4 Vrms)
- Connect the DC voltmeter to TP6, and adjust the voltage to 2.0 V with TC7. Aux switch turned ON (unused), and adjust the voltage at TP3 to the maximum with L17.
- Connect the frequency counter to TP5, and adjust the frequency to 12.79810 MHz ± 10 Hz with TC6.
- Set the AUX switch is at OFF, turn the (4)-(5)-RPT knob to position (4), connect the frequency counter to terminal LR, and adjust the frequency to 133.3 MHz ± 100 Hz with TC101.
- Set the AUX switch is at OFF, turn the (4)-(5)-RPT knob to position (5), and adjust the frequency to 134.3 MHz ± 100 Hz with TC102.
- Set the transceiver ready for transmission, turn the (4)-(5)-RPT knob to position RPT. Connect to frequency counter to terminal LT, and adjust the frequency to 133.7 MHz ± 100 Hz with TC5.
- Connect the power meter to the external antenna terminal, set the channel knob at Position 00, set the transceiver ready for transmission, connect the RF valve voltmeter to terminal LT, and adjust L18 until the meter reads maximum. (Reference voltage at terminal LT: Approx. 0.4 Vrms)

ADJUSTMENT

2. Operation Check

(1) Unlock function

Check that, when the Aux switch knob is at ON (unused channel) and the channel switch at the center, the frequency at terminal LR cannot be measured with the frequency counter.

(2) Channel switches

Check that, when the AUX switch is at OFF, (4)-(5)-RPT knob at (4), and the channel knob at Position "00", the frequency at terminal LR is 133.3 MHz \pm 100 Hz; when the switch is turned to Position 05, 10 and so on, the frequency changes at 25 kHz intervals; and when turn the (4)-(5)-RPT knob at ON, the 25 kHz step can be change frequency from 143.3 MHz.

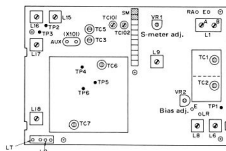

Fig. 13 RX Synthesizer Unit (X55-1220-61)

3. RX UNIT

1. RF Unit Adjustment

- Set the unit ready for reception, and turn the Aux switch is at ON (unused channel).
- Connect the sweep generator to the antenna terminal, and the detector to TP1.
- Increase the vertical gain of the oscilloscope to the maximum, and adjust the sweep generator frequency and output level so that an appropriate waveform can be obtained.
- Repeatedly adjust TC1, TC2 and L1 until a waveform, such as shown in Fig. 15, is obtained.

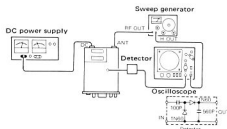

Fig. 14 RF Unit Adjustment



Fig. 15 Sweep Waveform

Table 8 Frequency

Step	Freq. indicated	④-⑤ RPT switch						Step	Freq. indicated	④-⑤ RPT switch					
		4		5		RPT				4		5		RPT	
		Operating frequency	L.R. terminal	Operating frequency	L.R. terminal	Receive	Transmit			Operating frequency	L.R. terminal	Operating frequency	L.R. terminal	Receive	Transmit
1	00	144.000	133.300	145.000	134.300	145.000	144.400	21	50	144.500	133.800	145.500	134.800	145.500	144.900
2	•	144.025	133.325	145.025	134.325	145.025	144.425	22	•	144.525	133.825	145.525	134.825	145.525	144.925
3	05	144.050	133.350	145.050	134.350	145.050	144.450	23	55	144.550	133.850	145.550	134.850	145.550	144.950
4	•	144.075	133.375	145.075	134.375	145.075	144.475	24	•	144.575	133.875	145.575	134.875	145.575	144.975
5	10	144.100	133.400	145.100	134.400	145.100	144.500	25	60	144.600	133.900	145.600	134.900	145.600	145.000
6	•	144.125	133.425	145.125	134.425	145.125	144.525	26	•	144.625	133.925	145.625	134.925	145.625	145.025
7	15	144.150	133.450	145.150	134.450	145.150	144.550	27	65	144.650	133.950	145.650	134.950	145.650	145.050
8	•	144.175	133.475	145.175	134.475	145.175	144.575	28	•	144.675	133.975	145.675	134.975	145.675	145.075
9	20	144.200	133.500	145.200	134.500	145.200	144.600	29	70	144.700	134.000	145.700	135.000	145.700	145.100
10	•	144.225	133.525	145.225	134.525	145.225	144.625	30	•	144.725	134.025	145.725	135.025	145.725	145.125
11	25	144.250	133.550	145.250	134.550	145.250	144.650	31	75	144.750	134.050	145.750	135.050	145.750	145.150
12	•	144.275	133.575	145.275	134.575	145.275	144.675	32	•	144.775	134.075	145.775	135.075	145.775	145.175
13	30	144.300	133.600	145.300	134.600	145.300	144.700	33	80	144.800	134.100	145.800	135.100	145.800	145.200
14	•	144.325	133.625	145.325	134.625	145.325	144.725	34	•	144.825	134.125	145.825	135.125	145.825	145.225
15	35	144.350	133.650	145.350	134.650	145.350	144.750	35	85	144.850	134.150	145.850	135.150	145.850	145.250
16	•	144.375	133.675	145.375	134.675	145.375	144.775	36	•	144.875	134.175	145.875	135.175	145.875	145.275
17	40	144.400	133.700	145.400	134.700	145.400	144.800	37	90	144.900	134.200	145.900	135.200	145.900	145.300
18	•	144.425	133.725	145.425	134.725	145.425	144.825	38	•	144.925	134.225	145.925	135.225	145.925	145.325
19	45	144.450	133.750	145.450	134.750	145.450	144.850	39	95	144.950	134.250	145.950	135.250	145.950	145.350
20	•	144.475	133.775	145.475	134.775	145.475	144.875	40	•	144.975	134.275	145.975	135.275	145.975	145.375
									Fixed channel	AUX					

ADJUSTMENT

2. IF Circuit Adjustment

- (1) Disconnect the sweep generator and detector, and connect SSG and AF valve voltmeter as shown in Fig. 16.
- (2) Turn the (4)-(5)-RPT knob to (5), channel knob to Position "00", and set the AUX switch at OFF.

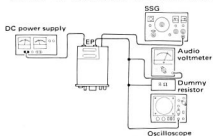

Fig. 16 IF Circuit Adjustment

- (3) Turn the AF volume control until the AF output (noise) is about 0.2 V/8 ohms, and adjust VR2 and L9 to the maximum noise output.
- (4) Set SSG as follows: $f = 145.00$ MHz; MOD = 1 kHz; DEV = 5 kHz; and ATT = 30 to 50 dB μ . Set the receiver in the best receiving condition, and turn the AF volume control until the AF output is 0.63 V/8 ohms.
- (5) Adjust SSG attenuation to 40 dB μ , and increase the AF output to the maximum with L9.
- (6) While adjusting SSG attenuation so that the S-meter reads 3 to 4, repeatedly adjust L6, L8 and VR2 a few times until the S-meter reads maximum.
- (7) Adjust SSG attenuation to -6 dB μ (0.5 μ V), and make a fine adjustment of the SSG frequency so that the best waveform and maximum output can be obtained. Check at this time that the signal-to-noise ratio is more than 20 dB.

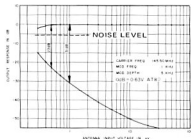

Fig. 17 Signal-to-Noise Ratio and Output Level vs Antenna Input Voltage

3. S-Meter Adjustment

- (1) Adjust SSG attenuation to 30 dB μ (30 μ V), and

adjust VR1 until the S-meter reads close to 10.

- (2) Adjust SSG attenuation to 20 dB μ (10 μ V), and turn VR2 clockwise until the S-meter reads S-8.

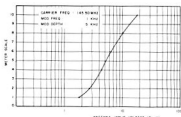

Fig. 18 S-Meter Operation Characteristics

4. Operation Check

- (1) Check that 20 dB NO sensitivity is less than -2 dB μ (0.8 μ V).
- (2) Check that the signal-to-noise ratio is more than 40 dB when SSG attenuation is 40 dB μ (100 μ V).
- (3) Squelch operation check:
 - Squelch threshold point: Anywhere from 9 to 11 (on clock dial)
 - Squelch sensitivity: Less than -10 dB μ (0.3 μ V)
- (4) AF output
 - Non-clip level: More than 2.4 V/8 ohms (0.7 V)
- (5) Current drain
 - Receive: Less than 45 mA

4. TX UNIT

1. Transmitting Output Adjustment

- (1) Set the following switches and knobs as follows:
 - Channel knob: "00"
 - Aux switch: OFF
 - (4)-(5)-RPT knob: (5)
- (2) Turn TC2 to the minimum position, and turn VR2 counterclockwise all the way to the minimum position. Connect the power meter to the EXT antenna terminal.
- (3) Set the unit ready for transmission, connect the RF valve voltmeter to TP1, and adjust L3 and L4 until the meter reads maximum. When meter reads has over 0.46 V (RMS), adjust the RF volt to 0.46 V with L3. (Reference voltage at TP1: 0.35 Vrms)
- (4) Connect the frequency counter to TP1, and adjust the frequency to 10.7 MHz \pm 100 Hz with TC1.
- (5) Connect the RF valve voltmeter to TP2, and adjust L5, L6, L7, L8 and VR1 repeatedly until the meter reads maximum. (Reference voltage at TP2: 1.5 Vrms)

ADJUSTMENT

- (6) Adjust TC2, TC3 and TC4 until the power meter reads maximum. Check that the transmitting output power is more than 1.5 W.
- (7) If current drain exceeds 500 mA, reduce the capacitance of TC3 so that there will be no current drain of more than 500 mA.
- (8) Adjust the transmitting output power to 1.2 W with VR2.

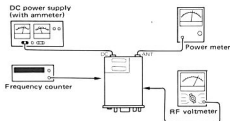

Fig. 19 Transmitter Adjustment

2. RF Meter Adjustment

- (1) Adjust the filter unit's VR1 until the RF meter reads B.



Fig. 20 Filter Unit

3. Transmitting Frequency Adjustment

- (1) Readjust TC1 so that the transmitting output frequency will be 145.00 MHz \pm 100 Hz.

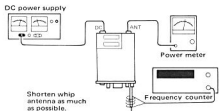

Fig. 21 Transmitting Frequency Adjustment

4-A Modulation Factor Adjustment (by use of linear detector)

- (1) Connect as shown in Fig. 22, and apply a signal of 1 kHz 15 mV from AG to the microphone terminal.
- (2) Set the AUX switch at OFF, and adjust VR4 until the linear detector reads 5 kHz.
- (3) Then adjust the AG output to 1.5 mV, and adjust VR3 until the linear detector reads 3.5 kHz.

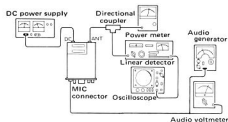

Fig. 22 Modulation Factor Adjustment

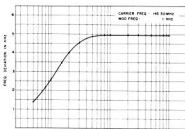

Fig. 23 Transmitting Frequency Deviation Characteristics

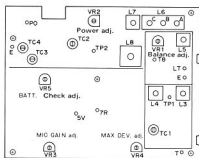

Fig. 24 TX Unit

4-B Simple Adjustment of Modulation Factor

- (1) Connect as shown in Fig. 25.
- (2) Apply a signal of 1 kHz 15 mV from AG to the microphone terminal, and adjust VR4 until the AF valve voltmeter connected to terminal T reads 0.54 V.
- (3) Adjust the AG output to 1.5 mV, and adjust VR3 until the voltage at terminal T is 0.35 V.

5. Tone Unit Adjustment

- (1) Set the following switches and knobs as follows:
 - Aux switch: ON (unused channel)

ADJUSTMENTS/DATA

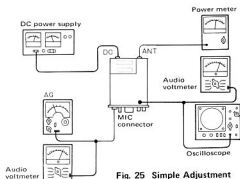

Fig. 25 Simple Adjustment of Modulation Factor

- Tone switch: ON
 - In case of W type it's unlock type switch. Push to tone switch during the adjustment.
 - Rec. (T type)
Send (W type)
- (2) Connect the test equipment to Fig. 27.
 - Connect the oscilloscope of vertical input terminal through the resistor $1\text{ M}\Omega$ between R5 470 Ω and Q1 (Collector).
 - Connect the frequency counter to AG and set the AG frequency "1,750 Hz", after connect the oscilloscope of horizontal terminal to AG output.
 - (3) Adjust VR1 until the wave of oscilloscope reads circle.
 - (4) Check that. Set the AUX switch is at OFF.
Set the transceiver ready for transmission. The linear detector reads more than ± 2.5 kHz.
 - (5) In case of T type, when change to transmitter from Receive. Adjust VR2 until take a modulation at 0.7 sec.



X52-1110-61 (W Type)
X52-1110-59 (T Type)

Fig. 26 Tone Unit

6. Operation Check

(1) Unlock function

Check that, when the Aux switch is at ON (unused channel) and the channel switch at the center, the transmitter sends no output power.

(2) Channel switches

Check that, when the AUX switch is at OFF, (4)-(5)-RPT knob at (5), and the channel knob at Position

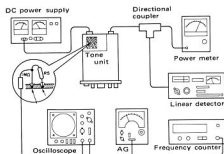

Fig. 27 Tone Unit Adjustment

"00", an output frequency of 145.00 MHz can be obtained; when the channel knob is turned to 05 and to 10, the frequency changes at 25 kHz intervals, the frequency rises by 20 kHz.

(3) Transmitting outputs at 00 and 975

Check that transmitting output power at Position 00 or 975 varies less than ± 0.2 W from the transmitting output power at Position 145.00.

(4) Current drain

Check that, when a 50-ohm load is connected to the external antenna terminal, current drain is less than 450 mA.

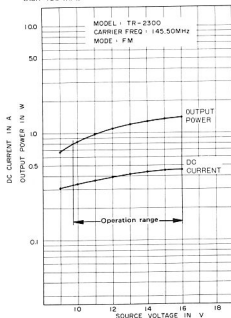

Fig. 28 Source Voltage vs Current Drain and Transmitting Output Power

OPTION/ACCESSORY

TRICKLE CHARGER [BC-1]

[W09-0005-05 (W type)]
[W09-0004-05 (T type)]

General

This battery charger is designed specially for Models TR-2300, TR-2200GX, and can charge the 10 built-in PB-15 (UM3 nickel-cadmium) dry cells in the transceiver.

Specifications

Input voltage:	AC 200 V, 50/60 Hz
Power consumption:	3 W max. (current 40 mA)
Output current:	DC 40 mA
Output voltage:	DC 14.5 V \pm 0.4 V

OPTION

NICKEL-CADMIUM BATTERY PACK [PB-15]

General

This pack holds nickel-cadmium dry cells for Models TR-2300, TR-2200GX. The pack consists of a case (PB-15A) holding 6 nickel-cadmium dry cells connected in series, and another case (PB-15B) holding 4 of them in series. It can be recharged by the battery charger BC-1 without removing the pack from the transceiver.

Specifications

Nominal voltage:	12 V (450 mAh)
	If PB-15A and PB-15B are combined.
	PB-15A 7.2 V 450 mAh
	PB-15B 4.8 V 450 mAh
Operating time:	Varies with transceiver models. See the instruction manual for your transceiver.
Charging current:	45 mA
Charging time:	Approx. 15 hours (when charged by BC-1)
Discharge cycle life:	More than 300 times
Operating temperature:	Charge: 6°C to +45°C
	Discharge: -20°C to +45°C
	Storage: -20°C to +45°C

HELICAL WHIP ANTENNA [RA-1]

This is a helical whip antenna for Model TR-2300.

Specifications

Type of antenna:	$\lambda/4$ helical antenna
Frequency range:	144 to 148 MHz
Impedance:	50 ohms
Operating temperature:	-20°C to +60°C
Dimensions:	180 mm long, 10 mm in diameter

SCHEMATIC DIAGRAM

- | | | | |
|-----------------|------------------|----------------|--------------------|
| Q1,2 :2SC460(B) | Q8,15 :2SC458(B) | Q13 :2SA562(Y) | D1 :1S2208 |
| Q3,4 :2SK19(GR) | Q9 :TA7061AP | Q14 :2SC496(Y) | D2,5,7,9,10:1S1555 |
| Q5 :3SK40(L) | Q10 :μPC78L08 | Q16 :μPC575C-B | D3,4:1N60 |
| Q6 :2SC2407 | Q11 :μPC78L05 | D6 :XZ-080 | |
| Q7 :2SC2329 | Q12 :2SC735(Y) | D8 :XZ-088 | |

— Signal line

--- OSC & Control line

— B line

● Adjusting point

- | | |
|-----------|-------------|
| 2SA495(Y) | 2SC733(Y) |
| 2SA562(Y) | 2SC735(Y) |
| 2SC458(B) | 2SC784(O) |
| 2SC460(B) | 2SC1000(GR) |

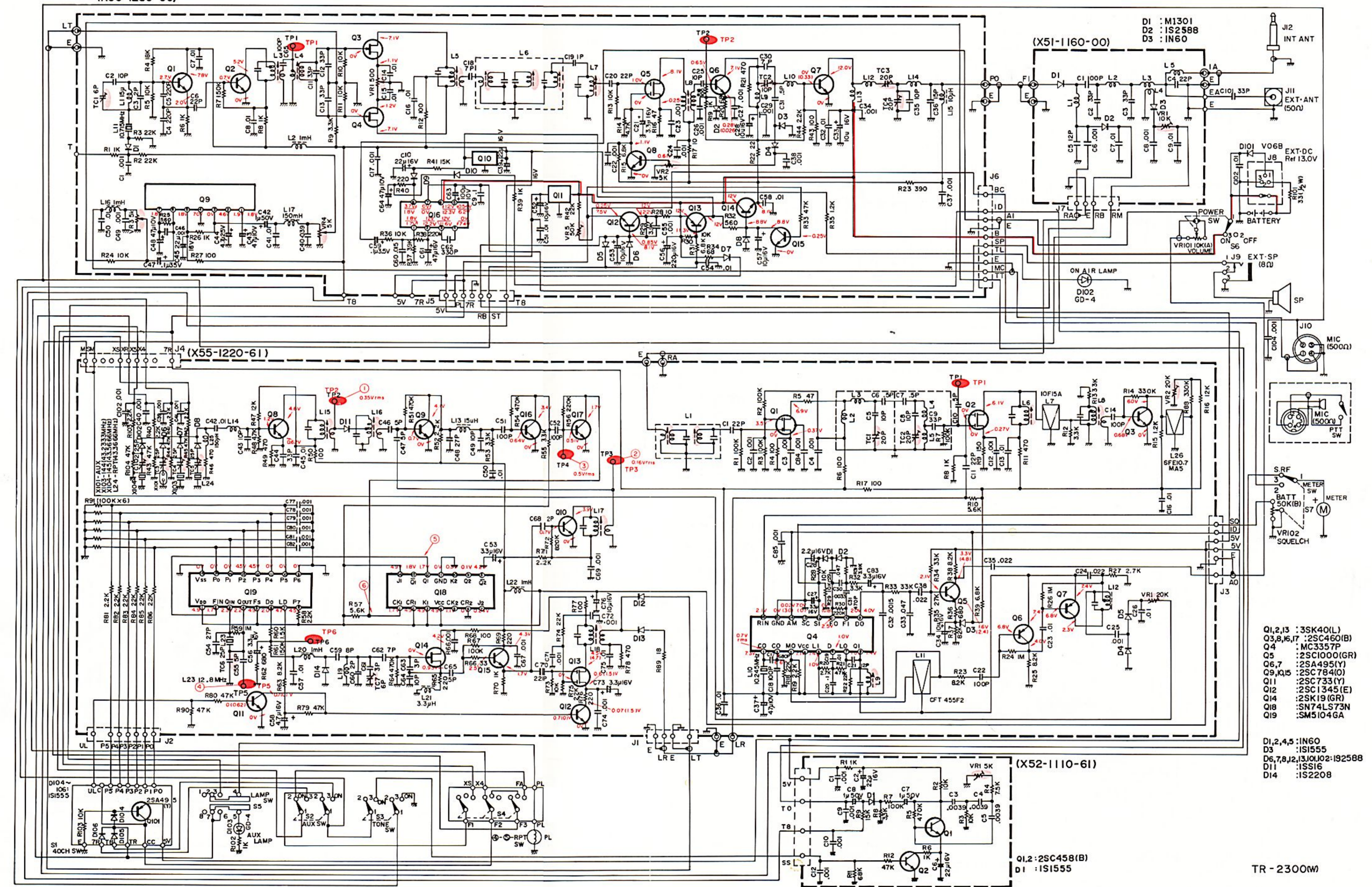
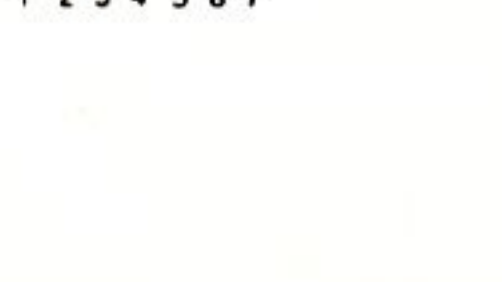
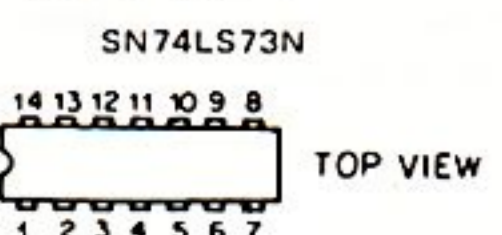
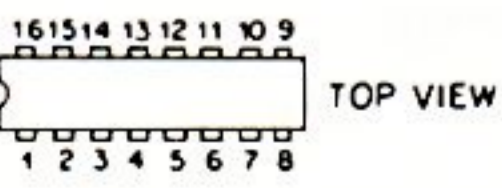
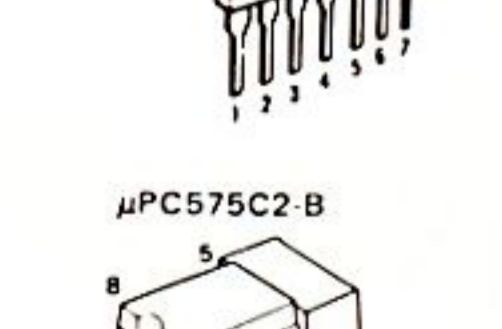
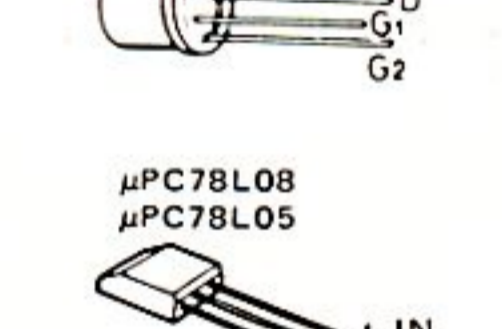
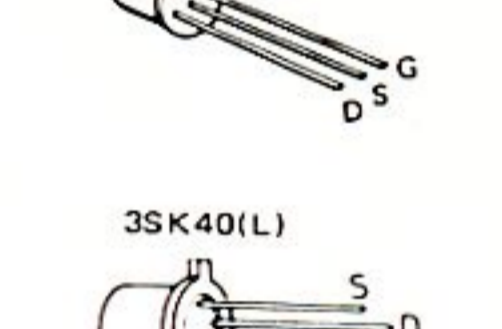
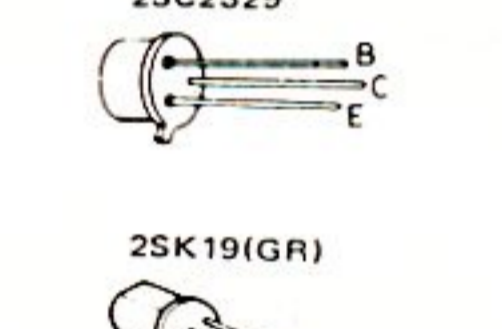
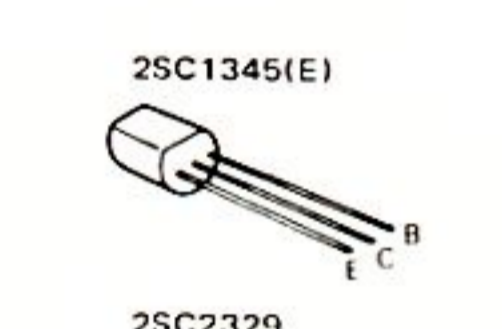
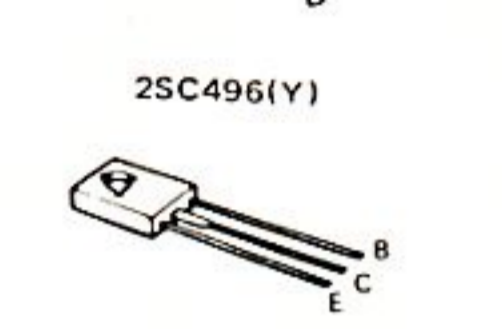
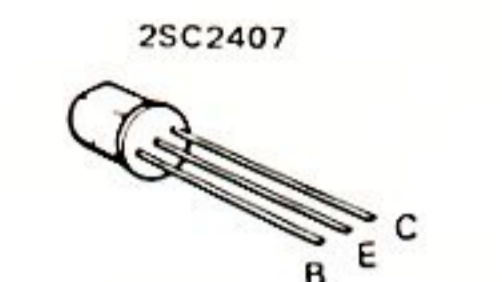
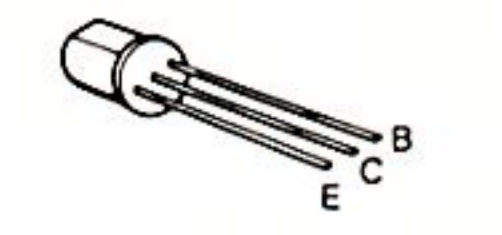

- | |
|-----------------------|
| Q1,2,13 :3SK40(L) |
| Q3,8,16,17 :2SC460(B) |
| Q4 :MC3357P |
| Q5 :2SC1000(GR) |
| Q6,7 :2SA495(Y) |
| Q9,Q15 :2SC784(O) |
| Q11 :2SC733(Y) |
| Q12 :2SC1345(E) |
| Q14 :2SK19(GR) |
| Q18 :SN74LS73N |
| Q19 :SM5104GA |

- | |
|----------------------------|
| D1,2,4,5:1N60 |
| D3 :1S1555 |
| D6,7,8,12,13,10,102:192588 |
| D11 :1S516 |
| D14 :1S2208 |

TR-2300(W)

- Note:**
1. Voltage values with parenthesis of Q6, Q7 (X52-1280-00): Voltage at no driving signal
 2. Voltage values with parenthesis of Q4, Q5 (X55-1220-00): Voltage at squelch ON
 3. Voltage values with parenthesis of Q11, Q12, Q13 (X55-1220-00): Voltage at unlock operation

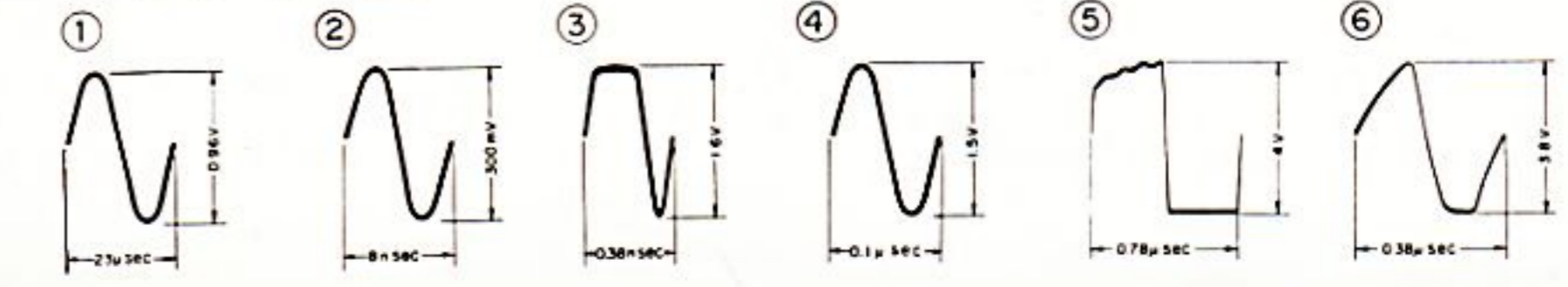

SPECIFICATIONS

GENERAL

Semiconductors	Transistors	22
	FET's	7
	IC's	7
	Diodes	30
Frequency Range	144.0 to 146.0 MHz	
Operating Temperature	-20°C to +50°C	
Standard Operating Voltage		
External	DC 13.0 V	
Internal	(1) UM3 nickel cadmium (Ni-Cd) cells (10 each) (2) UM3 dry cells (9 each)	
Operating Voltage Range	DC 9.6 to 16 V	
Grounding	Negative grounding	
Antenna Impedance	50 Ω	
DC Current (at DC 13.0 V)	Less than 45 mA in receive with no input signal Less than 450 mA in transmit at 1 W 50 ohms load	
Dimensions	122 mm (4-13/16")	wide
	51 mm (2")	high
	175 mm (6-7/8")	deep
Weight	Approx. 1.2 kg (2.64 lbs.) (with 10 Ni-Cd cells)	

TRANSMITTER SECTION

Transmitting Frequency	144 MHz band, 40 channels, 145 MHz band, 40 channels, AUX 1 channel	
Mode	FM	
RF Output Power	1 W	
Modulation	Variable reactance direct shift	
Maximum Frequency Deviation	±5 kHz	
Spurious Radiation	Less than -60 dB (Less than -50 dB for harmonics)	
Microphone	Dynamic microphone with PTT switch, 500 Ω	

RECEIVER SECTION

Receiving Frequency	144 MHz band, 40 channels, 145 MHz band, 40 channels, AUX 1 channels	
Mode	FM	
Circuitry	Double superheterodyne	
Intermediate Frequencies	10.7 MHz (1st IF)	
	455 kHz (2nd IF)	
Receiver Sensitivity	S/N more than 30 dB for 1 μV input 20 dB noise quieting less than 0.4 μV	
Squelch Sensitivity	Less than 0.25 μV	
Pass Band Width	More than 14 kHz at -6 dB down	
Selectivity	Less than 32 kHz at 60 dB down	
Audio Output	More than 0.7 W across 8 ohms load (10% distortion)	

Note: The circuit and ratings may change without notice due to development in technology.

A product of
TRIO-KENWOOD CORPORATION
8-17, 3-chome, Aobadai, Meguro-ku, Tokyo 153, Japan

TRIO-KENWOOD COMMUNICATIONS, INC.
111 West Walnut Street, Lumberton, California 95230 U.S.A.
TRIO-KENWOOD COMMUNICATIONS, GmbH
D-8314 Spessart 75, Indersdorf, G.F.R. West Germany
TRIO-KENWOOD (AUSTRALIA) PTY. LTD.
32 Wilson Street, Brisbane, Australia 4004