

KENWOOD

144/440/1200 MHz FM TRIBANDER
144/430/1200 MHz FM TRIBANDER

TM-942A

144/440 MHz FM MULTI BANDER

TM-742A

144/430 MHz FM MULTI BANDER

TM-742A/E

144/220 MHz FM MULTI BANDER

TM-642A

INSTRUCTION MANUAL

KENWOOD CORPORATION

©PRINTED IN JAPAN B62-0287-70(KPMJQ)(MC)
95/12 11 10 9 8 7 6 5 4

Thank you for purchasing this new transceiver.

IMPORTANT:

Please read this instruction manual carefully before placing your transceiver in service. You will find it time well-spent.

CAUTION:

Long transmissions or extended operation in the HI power mode might cause the rear of this transceiver to get warm. Do not place the transceiver where the heat sink (rear panel) might come in contact with plastic or vinyl surfaces.

This Instruction Manual covers the following models.

TM-642A: 144/220 MHz FM MULTI BANDER
(U.S.A. and Canadian markets)

TM-742A: 144/440 MHz FM MULTI BANDER
(U.S.A. and Canadian markets)

TM-742A/E: 144/430 MHz FM MULTI BANDER
(General and European markets)

TM-942A: 144/440/1200 MHz FM TRIBANDER
(U.S.A. and Canadian markets)

TM-942A: 144/430/1200 MHz FM TRIBANDER
(General markets)

NOTE: *If disregarded, inconvenience only, no risk of equipment damage or personal injury.*

CAUTION: *Equipment damage may occur, but not personal injury.*

Save this Instruction Manual.

Notice to the user:

One or more of the following statements may be applicable to this equipment.

FCC WARNING

This equipment generates or uses radio frequency energy. Changes or modifications to this equipment may cause harmful interference unless the modifications are expressly approved in the instruction manual. The user could lose the authority to operate this equipment if an unauthorized change or modification is made.

Information to the digital device user required by the FCC:

This equipment has been tested and found to comply with the limits for a Class B digital device, pursuant to Part 15 of the FCC Rules. These limits are designed to provide reasonable protection against harmful interference in a residential installation. This equipment generates radio frequency energy and, if not installed and used in accordance with the instructions, may cause harmful interference to radio communications. However, there is no guarantee that the interference will not occur in a particular installation. If this equipment does cause harmful interference to radio or television reception, which can be determined by turning the equipment off and on, the user is encouraged to try to correct the interference by one or more of the following measures:

- Reorient or relocate the receiving antenna.*
- Increase the separation between the equipment and receiver.*
- Connect the equipment to an outlet on a circuit different from that to which the receiver is connected.*
- Consult the dealer for technical assistance.*

This Instruction Manual consists of the following sections:

SECTION 1 Basic Transmit/Receive and Memory Operation

This section outlines the basic items you should know in order to properly operate the transceiver.

- | | |
|-----------------------------|-------------------------|
| ① BEFORE OPERATION | ⑤ RECEIVER OPERATION |
| ② ACCESSORIES | ⑥ TRANSMITTER OPERATION |
| ③ INSTALLATION INSTRUCTIONS | ⑦ MEMORY BASICS |
| ④ OPERATING CONTROLS | |

SECTION 2 Mastering the Transceiver

This section details operating instructions for the transceiver.

- | | |
|-------------------------------|------------------------------|
| ① ADVANCED RECEIVE FUNCTIONS | ⑥ OTHER USEFUL FUNCTIONS |
| ② ADVANCED TRANSMIT FUNCTIONS | ⑦ REMOTE CONTROL |
| ③ MEMORY | ⑧ DISPLAY DEMONSTRATION MODE |
| ④ SCAN | ⑨ CLOCK |
| ⑤ REPEATER OPERATION | |

SECTION 3 Specialized Communication Modes

This section provides detailed information on several tone signalling modes.

- | | |
|-------------------|---------------------|
| ① CTCSS OPERATION | ③ PAGE |
| ② DTSS OPERATION | ④ TONE ALERT SYSTEM |

SECTION 4 Useful Information

This section provides other general information.

- | | |
|-----------------------------------|-------------------|
| ① MAINTENANCE | ④ SPECIFICATIONS |
| ② OPTIONAL ACCESSORIES | ⑤ QUICK REFERENCE |
| ③ INSTALLING OPTIONAL ACCESSORIES | |

Find It Fast

For quick access to transceiver features and functions, consult these handy listings:

- Contents (page 5 through 7)
- Quick Reference (page 102 through 105)

Rules for Description

The descriptions in this instruction manual are based on the following rules, unless otherwise noted.

- The displays and panel illustrations for the TM-742A (U.S.A. version) are used as examples.
- The 144 MHz band is used as the operating band for explanations.
- Operations are in the VFO mode unless otherwise specified.

- The operating procedures are described according to the following rules.

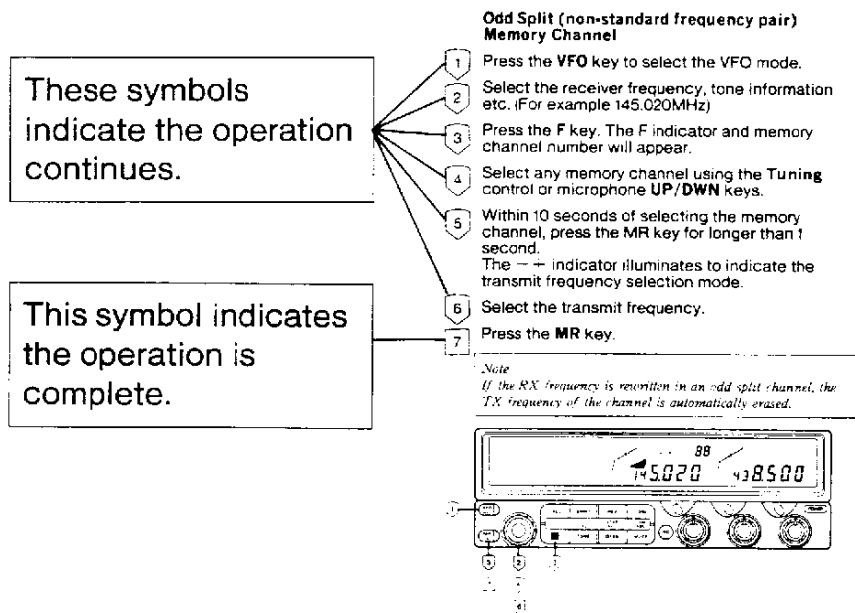

CONTENTS

SECTION 1 Basic Transmit/Receive and Memory Operation

BEFORE OPERATION	8
ACCESSORIES	9
INSTALLATION INSTRUCTIONS	
Installing the Microphone	10
Mobile Installation	10
Battery Connections	11
Fixed Station	12
Antenna	13
OPERATING CONTROLS	
Front Panel Keys, Controls, and Labeling	14
Difference between the C.SEL and BAND SEL Keys	16
C.SEL and BAND SEL Keys for Each Model	16
Rear Panel and Side Case	17
Microphone	18
Display Panel	19
RECEIVER OPERATION	21
TRANSMITTER OPERATION	24
MEMORY BASICS	
Memory Channels	25
Storing Information into Memory	25
Memory Channel Recall	26

SECTION 2 Mastering the Transceiver

ADVANCED RECEIVE FUNCTIONS

A.B.C.(Automatic Band Change)	27
MUTE	27
Microprocessor Squelch Control	28
S-Meter Squelch Control	28
Attenuator ON/OFF	29
ALT (Automatic Lock Tuning)	30
Receive Audio Output Band Selection (Microphone RD Terminal)	31

ADVANCED TRANSMIT FUNCTIONS

Time-Out Timer (TOT)	32
Transmit Alert	32
10 M Transmit Bandwidth Selection	33
Locking the Transmit Band	33

MEMORY

Microprocessor Memory Back-up	34
Microprocessor Defaults	34
Reset (Microprocessor Initialization)	34
Memory Contents	35
Rewriting Call Channel Data	36
Memory Banks	36
Clearing Memory	39
Memory Shift	39

SCAN

Scan Options	40
Hold/Resume Programming	41
Band Scan	41
Programmable Band Scan	42
MHz Scan	43
Memory Channel Scan	43
Locking Out Memory Channels	44
CALL/VFO Scan	44
CALL/Memory Channel Scan	44
V/M/C (VFO/Memory/Call) Scan	44
Automatic Memory Scan	45

REPEATER OPERATION

Transmitter Offset	46
Selecting the Offset Direction	46
Automatic Offset	46
Reverse Function	47
Tone Operation	48
Autopatch Operations	
(U.S.A./Canada version only)	49
DTMF (dialer) Memory	49

OTHER USEFUL FUNCTIONS

Frequency Step Selection	51
Programmable VFO Tuning Limit	52
Microphone Key Functions:	
Custom Reassignment	54
Beep Tone Frequencies	55
Automatic Power Off (APO)	56
Dimmer (DIM)	56
Beep Tone Level Adjustment	57
Clearing Unused Bands from the Display	57
Key Locks	58
Operation as a Repeater	
(U.S.A./Canada version)	59

REMOTE CONTROL

Pushbutton Control Using the DTMF	
Microphone	61

DISPLAY DEMONSTRATION MODE

CLOCK

Setting Time and Date	66
Other Clock Functions	67

SECTION 3 Specialized Communication Modes

CTCSS OPERATION	70
DTSS OPERATION	
Preparation for DTSS Operation	72
DTSS Code Selection	72
Using the DTSS function	73
Setting Delay Time	74
Intercom using DTSS codes	75
Control by External DTMF Signal	75
PAGE	
Page Code Memories	77
Code Selection	78
Code Transmission	79
Page Code Monitoring	80
Code Lockout	81
Answer-Back(U.S.A./Canada version)	81
Automatic Page Cancel (U.S.A./Canada version)	81
TONE ALERT SYSTEM	82

SECTION 4 Useful Information

MAINTENANCE

General Information	84
Service	84
Service Note	84
Caution	84
In Case Of Difficulty	85

OPTIONAL ACCESSORIES

INSTALLING OPTIONAL ACCESSORIES

CTCSS Unit (TSU-7)	88
Detachable Front Panel Kit (DFK-4/7)	89
Detachable Front Panel Kit (DFK-3)	91
BAND UNITS	94

SPECIFICATIONS

QUICK REFERENCE

NOTICE

One additional band can be installed in the TM-642A or TM-742A/E using options described in this manual. Operating instructions remain the same for the transceiver when used as a dual band or triband configuration.

BEFORE OPERATION

To prevent electric shock, fire and other injury, please note the following:

Never remove the case unless instructed to do so in this Instruction Manual. If parts internal to the unit are accidentally touched, you may receive a serious electric shock.

Do not place this unit where it will be exposed to direct sunlight or close to heating appliances.

To ensure good ventilation, do not place anything on top of the cabinet. Allow at least 15 cm (6 inches) of space behind the unit.

The power requirement is 13.8 V DC, negative ground. Never attempt connection to a 24 V DC source.

Do not place the unit in areas of excessive dust, high humidity or on an unstable surface.

Do not drop or otherwise insert electrically conductive materials into the unit.

Do not touch the power plug with wet hands.

If an abnormal odor or smoke is detected, immediately turn the power off. Contact a KENWOOD service station, or your dealer for service instructions.

Cleaning

1. Turn the power off before cleaning the unit.
2. Do not use any type of abrasive pad, thinner, benzene or any substances which may damage the unit's finish.
3. Wipe the front panel and other exterior surfaces of the unit with a soft dry cloth or a soft cloth slightly moistened with water.

ACCESSORIES

Unpack your new transceiver carefully, and examine it for visible damage. If the equipment has been damaged in shipping, you should immediately notify the shipping company.

The following accessories are supplied with the transceiver, depending upon the destination or geographic market area.

DTMF MicrophoneT91-0397-XX1
(U.S.A. and Canada)		
or MicrophoneT91-0398-XX1
(Europe)		
or MicrophoneT91-0396-XX1
(General market)		
DC Power CableE30-3034-XX1
Microphone HookJ20-0319-XX1
(U.S.A. and Canada)		
Self-tapping ScrewsN46-3010-XX2
(U.S.A. and Canada)		
Mobile Mounting Kit		
BracketJ29-0454-XX1
Screw setN99-0331-XX1
Allen WrenchW01-0414-XX1
Fuse (15A)F51-0017-XX1
Instruction ManualB62-0287-XX	1 copy
Warranty Card	1sheet
(U.S.A., Canada and Europe)		

After unpacking

Save the boxes and packing in the event your unit needs to be transported for remote operation, maintenance, or service.

INSTALLATION INSTRUCTIONS

This transceiver can be separated into an RF deck (radio) and a Control Panel. The separated Control Panel can be further divided into a Display unit and a Control unit.

Kits, available as options, are required for this special installation. (See page 89.)

Installing the Microphone

Before installing the microphone, turn OFF the Power switch.

- 1 Press the release button on the left side of the panel. Carefully pull the front panel forward from the left, then remove it completely. Be careful with the cord connecting the front panel to the chassis. (Fig. 1)
- 2 Insert the microphone connector into the microphone jack on the right of the main unit, until it clicks. Make sure the tab on the connector is on top.
- 3 Position the microphone cable as shown in the drawing and carefully reinstall the front panel. (Fig. 2)

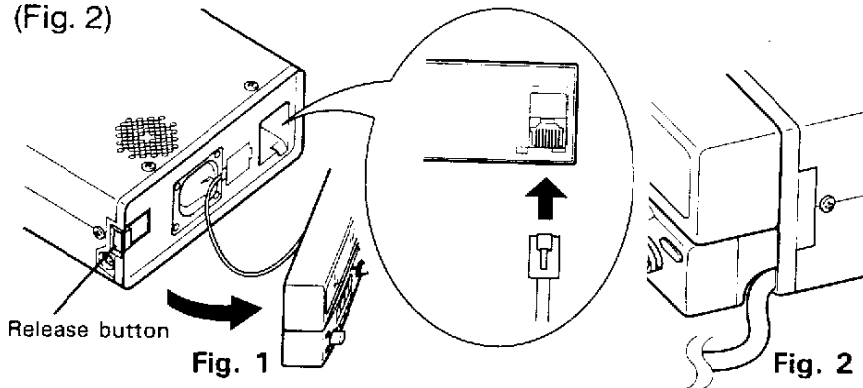

Mobile Installation

Note

- 1 Before installing the transceiver, consider both the ease of operation and occupant safety. Consider the location, controls accessibility and display visibility.
- 2 Install the bracket permanently and securely so that it will not accidentally detach due to vibration or mechanical shock.

Mounting Bracket

- 1 Install the bracket using the supplied flat washers and self-tapping screws (4 pcs. each).
- 2 Attach the transceiver into the bracket using the SEMS screws (4 pcs.). Do not tighten yet.
- 3 Adjust the viewing angle of the transceiver in the bracket.
- 4 Hold the transceiver at the selected viewing angle and tighten the 4 SEMS screws using the supplied wrench.

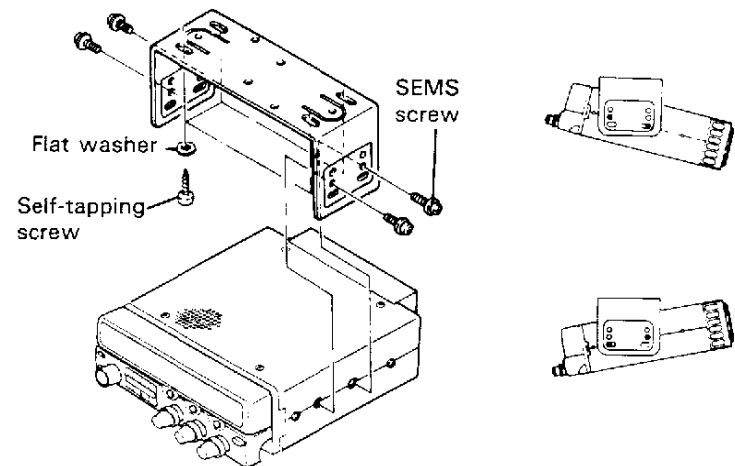

Battery Connections

Connect the power cable directly to the vehicle battery terminals. Do not use the cigarette lighter socket. It cannot supply sufficient current for proper operation of the transceiver. Pay specific attention to the polarity of the cables when connecting them to the battery.

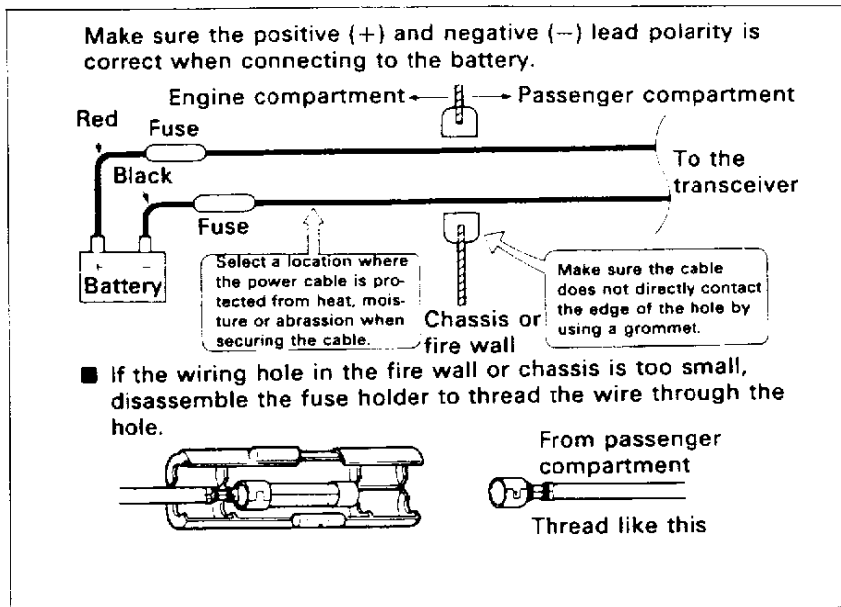

Caution

Provide sufficient space around the rear panel and the fan for good ventilation.

Caution

- 1 Before installing the power cable, remove all negative leads from the vehicle battery.
- 2 After installation and wiring, double check for correct installation before reconnecting the negative lead to the vehicle battery terminal.
- 3 If the fuse opens, check each lead for damage by short circuiting, etc. Then replace the fuse with a new one of the same type and rating.
- 4 After the wiring is completed, wrap the fuse holder with heat resistant tape to protect against moisture intrusion.
- 5 Do not remove the fuse holder assembly from the cable, even if the power cable is too long.

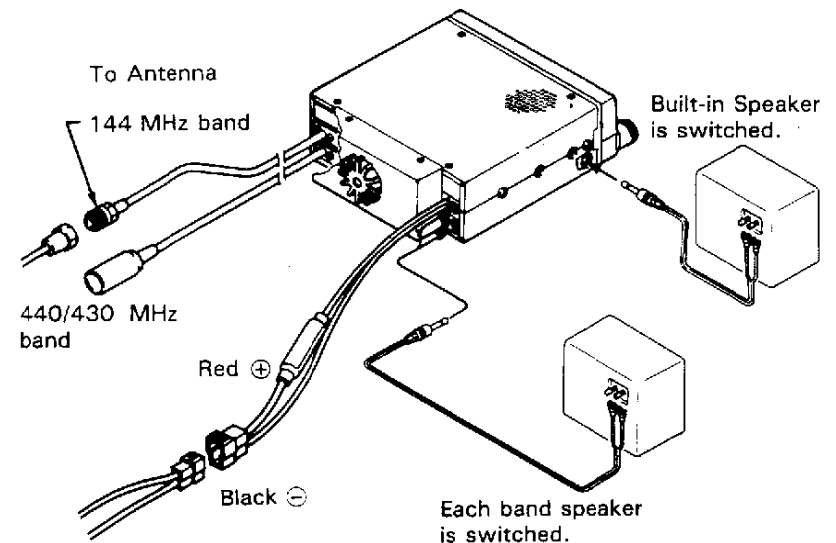

Fixed Station

A regulated DC power supply (13.8 V DC, capable of supplying at least 12 amperes) is required.

The PS-430 or the PS-33 are recommended.

Caution

- 1 Do not connect the AC power cable to the AC outlet until all other connections have been made and double checked.
- 2 Before connecting or disconnecting the power connector, be sure to turn OFF the POWER switches of both the transceiver and the DC power supply.
- 3 Observe polarity of the DC power cable. The transceiver operates on 13.8 V DC, negative ground. Battery or supply polarity must be correct. The power cable is color coded as below :

Red → + (Positive polarity)

Black → - (Negative polarity)

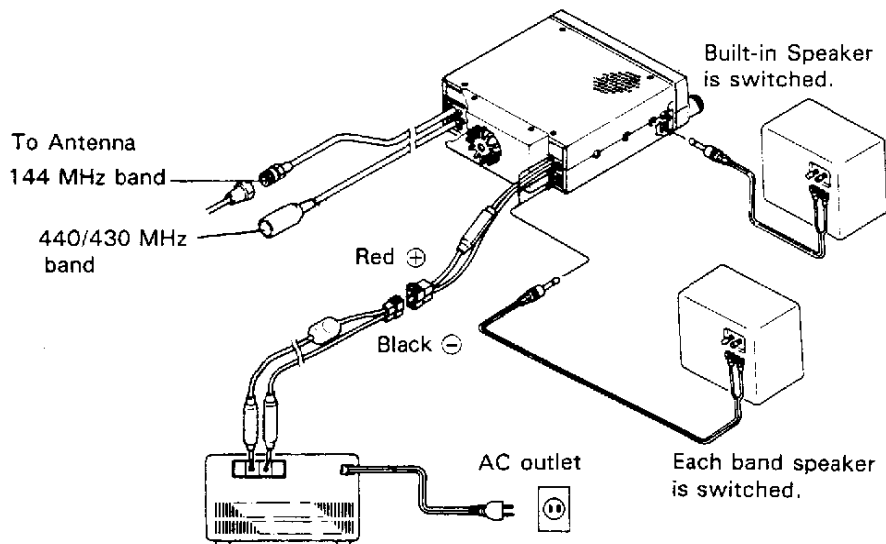

Caution

Provide sufficient space around the rear panel and the fan for good ventilation.

Antenna

The type of antenna that is used will greatly affect the performance of the transceiver. Use a properly adjusted antenna, of good quality, to enable your transceiver to perform to its maximum potential. The antenna input impedance is 50 ohms. Therefore, use 50-ohm coaxial cable such as RG-58U for this connection. If the antenna location is far from the transceiver, use low loss coaxial cable such as RG-8U. A properly installed antenna and coaxial feed line will exhibit an SWR of less than 1.5 to 1.

The transceiver protection circuit will activate if the SWR is poor (greater than 3 to 1).

A high SWR will cause the transmitter output to drop, and may lead to TVI or BCI complaints.

Caution

It is highly recommended that you install commercially available lightning arresters in all of your antenna lines for protection against equipment damage, fire, electric shock, or personal injury.

OPERATING CONTROLS

Front Panel Keys, Controls, and Labeling

VFO: Variable Frequency Oscillator

This key is used to select the VFO mode. In this mode the frequency is changed by either turning the Tuning control, or by pressing the UP/DWN keys on the microphone.

M▶V:

Press the F key and then this key to copy the contents of the current memory channel to the VFO.

MR: Memory Recall

Use this key to select the MR mode. In this mode a memory channel may be selected by either turning the Tuning control or by pressing the UP/DWN keys on the microphone.

M: Memory

Press the F key and then this key to write current VFO information into memory.

RC: Remote Control

Use this key to activate remote control. See page 61 through 63 for additional information on this function.

POWER:

Use this switch to turn the power ON. The -ON- indicator appears when the switch is pressed, then about a second later the frequency display will appear.

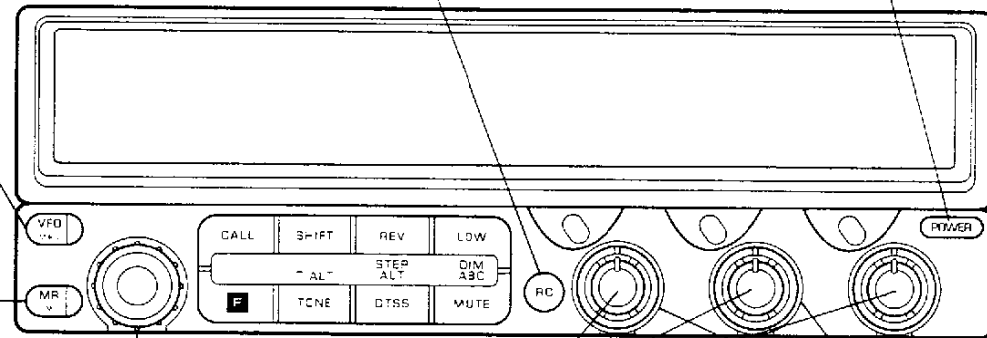

Tuning control:

Use this control to select the operating frequency, memory channel, etc.

MHz:

Use this key to select 1 MHz tuning steps.

VOL: Volume

Use this control to adjust the volume from the internal and external speaker (if used). Clockwise rotation increases the volume.

SQL: Squelch

Use this control to set the squelch threshold. This will eliminate the background noise when no signal is present.

Note

Red lettering indicates an operation performed by first pressing the F key, then that key.

REV: Reverse

Use this key to reverse the transmit and receive frequencies during repeater operation. This key does not function in the simplex mode.

STEP:

Use with the F key to program the tuning step size. See page 51 for additional information on this function.

LOW:

Use this key to select the transmitter output power.

DIM: Dimmer

Use with the F key to select the front panel display illumination intensity. See page 56 for additional information on this function.

SHIFT:

Use this to select the transmitter offset for repeater operation.

CALL:

Call channel. Press this key to select the Call Channel frequency.

F: Function

Use this key along with the other front panel keys to select secondary key functions or to re-configure the transceiver.

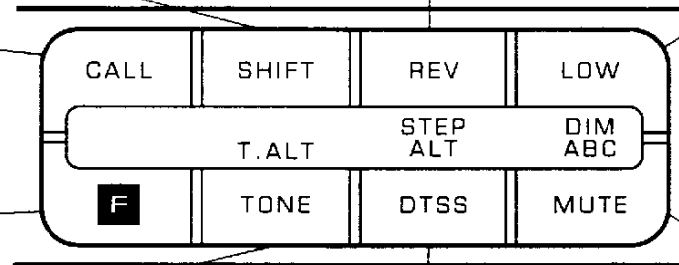

TONE:

Use this key to activate the sub-audible tone encoder.

T.ALT: Tone Alert

Use with the F key to activate the Tone Alert function. See page 82 for additional information on this function.

DTSS:

Dual Tone Squelch System
Use with the F key to activate the DTSS system. See page 72 for additional information on this function.

ALT: Automatic Lock Tuning

Use with the F key to activate the Automatic Lock Tuning function. See page 30 for additional information on this function.

MUTE:

Use this key to reduce the received audio level of one band, when you are transmitting on the other band.

ABC: Automatic Band Change

Use with the F key to activate the ABC function. See page 27 for additional information on this function.

Difference between the C.SEL and BAND SEL Keys

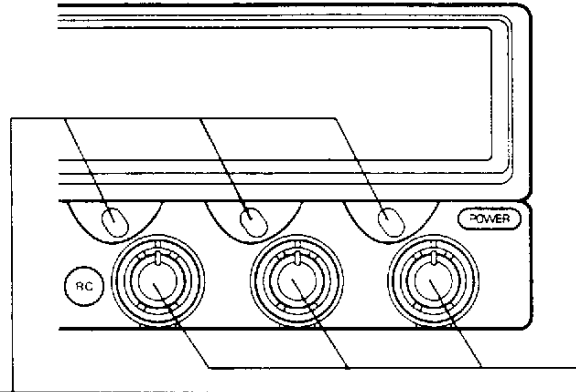

C.SEL (Press)

Press to select the band you wish to control with the front panel controls.

The "C" () indicator will appear and show which band has been selected.

The green LED also illuminates to show which band is currently under front panel control.

BAND SEL (Press)

Press to select the desired transmit band. These keys are also used to select the band to be controlled from the front panel.

When pressed, the "PTT" () indicator will flash to show which transmit band has been selected.

C.SEL and BAND SEL Keys for Each Model

TM-642A

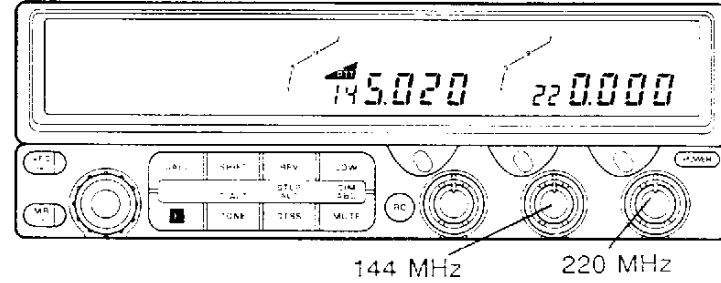

TM-742A/E

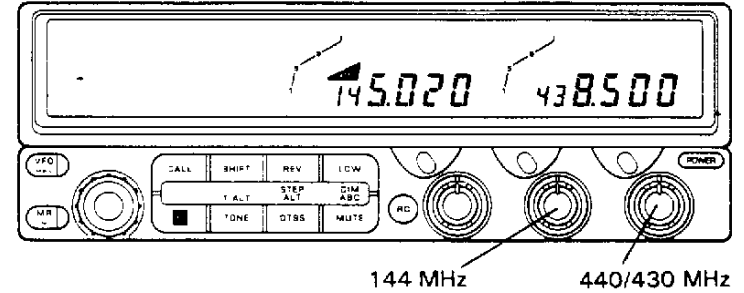

TM-942A

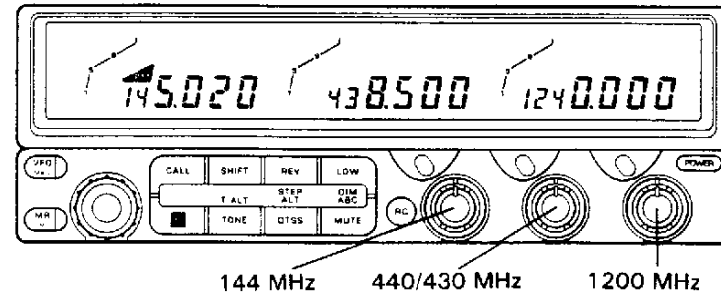

Rear Panel and Side Case

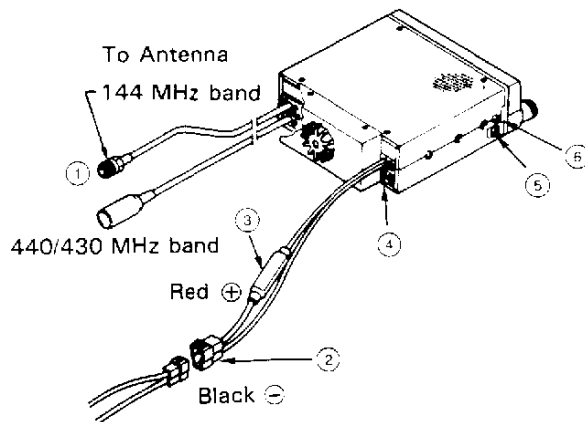

- ① ANTENNA connector
Connect a 50 ohm feedline and antenna with a low SWR.
- ② 13.8 VDC power input connector
Connect the supplied DC power cable to this connector.
Pay specific attention to the polarity. Red is positive and black is negative.
- ③ Fuse holder
Contains a 15A fuse. NEVER use a larger fuse.
Damage to the transceiver will result.

④ External speaker jack (Rear panel)

There are external speaker jacks for each band. When an external speaker is connected, the receive audio for that band is heard from the external speaker.

The speaker should have an impedance of 8 ohms or greater.

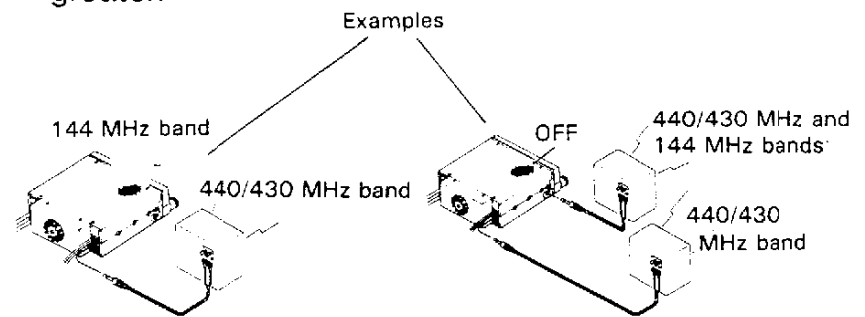

⑤ External speaker jack (Side case)

The internal speaker is disabled when the external speaker is installed.

⑥ Release button

Press this button to release and detach the Control Panel.

Microphone

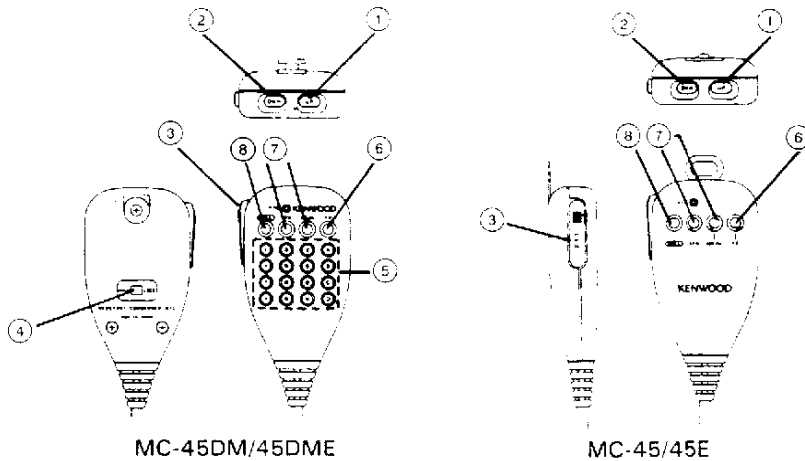

MC-45DM/45DME

MC-45/45E

①②UP/DWN keys

Use these keys to tune the VFO up or down, increase or decrease the memory channel number, change the Tone frequency, etc.

③PTT(Push to Talk) switch

Depress this switch to place the transceiver in the transmit mode. Scanning may also be canceled by pressing this switch once (without transmitting).

④LOCK

This slide switch will deactivate all microphone functions except PTT and the DTMF keypad.

⑤DTMF keypad

Use this 16 button pad to operate the DTMF encoder.

⑥PF(Programmable Function) key

This key has been preprogrammed at the factory as the BAND SEL key. The transmit band changes each time this key is pressed.

Note

Pressing the PF key for longer than one second does not initiate scanning.

The PF key can also be used as the MONITOR or ENTER key to perform other key functions, or a function that is not available on the transceiver front panel. (See page 54.)

⑦VFO key MR key ⑧ CALL key (MC-45/45DM)





These keys duplicate the functions of the CALL, VFO, or MR keys on the transceiver front panel. Depress the CALL, VFO, or MR key for more than one second to initiate scan. Any of these keys can be reprogrammed to function as a PF key. (See page 54)

⑧1750key (MC-45E/45DME)

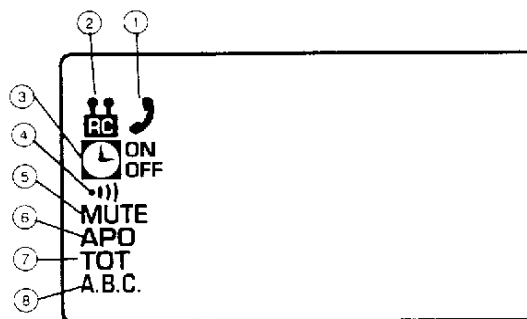
The transceiver will transmit with a 1750 Hz repeater access tone when this key is depressed.

Display Panel



- ①  On when the Intercom function is On.
- ②  On when the Remote Control function is On.
- ③  On when the On-Timer or Off-Timer function has been activated.
- ④  On when the Alarm function has been activated.
- ⑤ **MUTE** On when the volume of the RX band is reduced.
- ⑥ **APO** On when the Automatic Power Off function has been activated.
- ⑦ **TOT** On when the transmitter Time-Out Timer function is On.
- ⑧ **A.B.C.** On when the Automatic Band Change function is On.

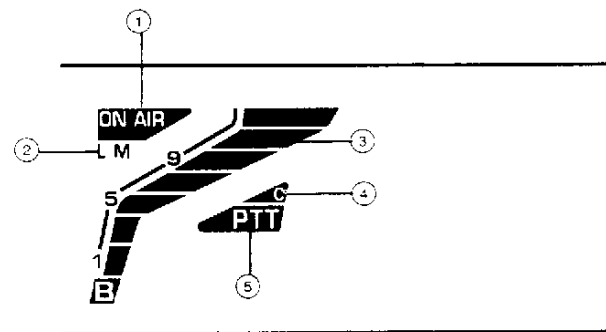

- ① **ON AIR** On during Transmit.
- ② **L M** Indicates the relative Transmitter Output Power setting. No indicator means full power.
- ③  The level meter indicates the relative receiver signal strength or the relative transmitter power output.
On when the squelch opens (busy).
- ④ **G** On when the Control Band is selected.
- ⑤ **PTT** On when the TX band is selected. Flashes when the transmit band is locked.

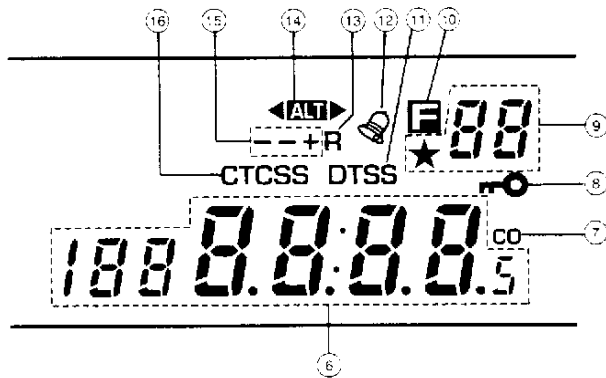

- ⑥ **1888.8:8.8.5** Displays the operating frequency, or the tone frequency.
 - On when receive detection output is fixed in the band.
 - The indicator flashes when scanning.
- ⑦ **CO** On when Carrier Operated scan is selected.
- ⑧ **LOCK** On when the Lock function is ON.

- ⑨ **★88** Shows the last memory channel number that was selected. The ★ indicator is on when the Memory channel will be skipped during Memory channel scan.
- ⑩ **F** On after the F key has been depressed.
- ⑪ **DTSS** On when the DTSS function is active.
- ⑫ **Bell** On when the Tone Alert function is active.
- ⑬ **R** On when the Reverse function is active.
- ⑭ **ALT** 1200 MHz band only; On when the Automatic Lock Tuning function is active. 28/50 MHz band only; On when the Attenuator is ON.
- ⑮ **---+** Displays the transmitter offset direction.
- ⑯ **CTCSS** With the optional CTCSS unit TSU-7 installed: On when the Tone Decode function is active.

RECEIVER OPERATION

Before switching the power ON to the transceiver, set the controls as follows:

Fixed station:
Regulated DC power supply power switch: Off

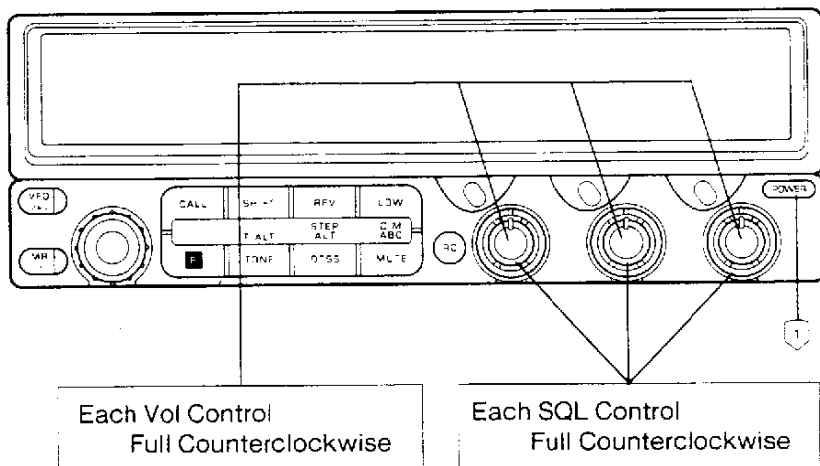

- 1 First, turn on the regulated DC power supply, then press the **POWER** switch on the transceiver. A frequency will be displayed after approximately one second.

Note

- 1 When switching on the transceiver, wait until frequencies appear on the display after the word "ON" before pressing any function keys. Ignoring this procedure may initiate one of the functions that requires a key to be held down while turning on power.
- 2 After the power is switched on, the display intensity decreases 1 step to extend the life of the lamps.

The display for each model is shown:

TM-642A (U.S.A./ Canada version)

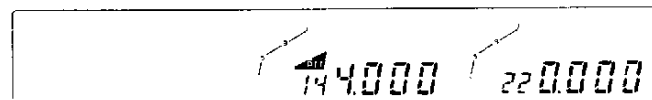

TM-742A (U.S.A./ Canada version)

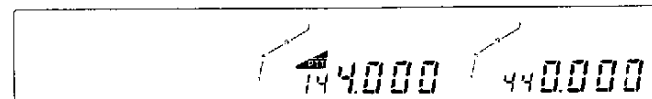

TM-742A (General Market)

TM-742E (Europe version)

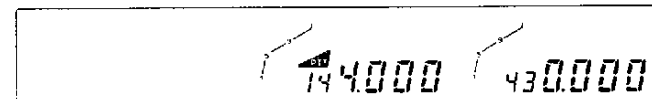

TM-942A (U.S.A./Canada version)

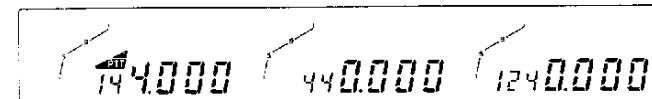

TM-942A (General Market)

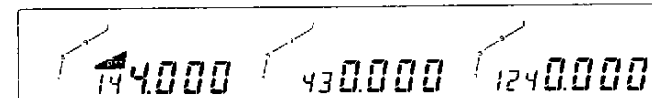

These frequencies are the default frequencies after a microprocessor reset. If the display shows incomplete data, or if you think the displayed frequency is in error you can reset the microprocessor. (Microprocessor Initialization information is on page 34)

Perform the following control sequence for each band.

- 2 Press the desired band **BAND SEL** or **C. SEL** key. The operating band indicator lights (green).

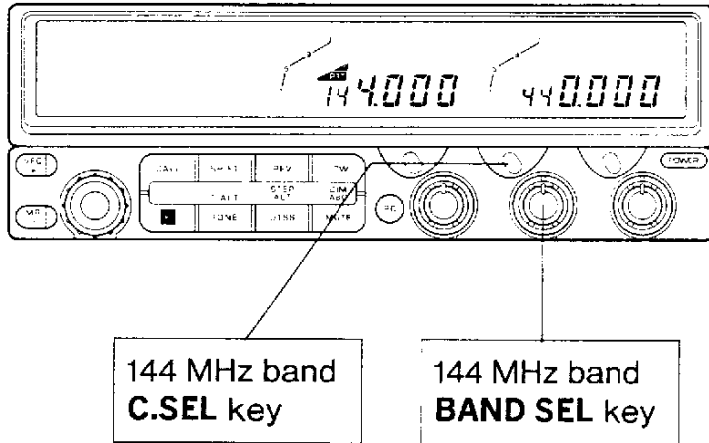

- 3 Rotate the **VOL** control clockwise until a signal or noise is heard from the speaker.
- 4 Press the **VFO** key to select the VFO mode.

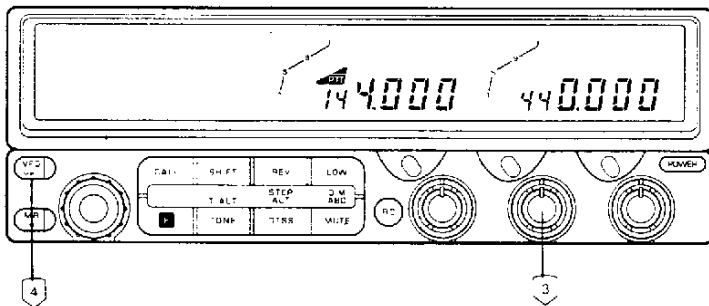

- 5 Rotate the **Tuning** control or press the microphone **UP/DWN** keys to select an open channel.
- 6 Rotate the **SQL** control clockwise until the noise just disappears and the **BUSY** indicator turns off. (just past the squelch threshold).

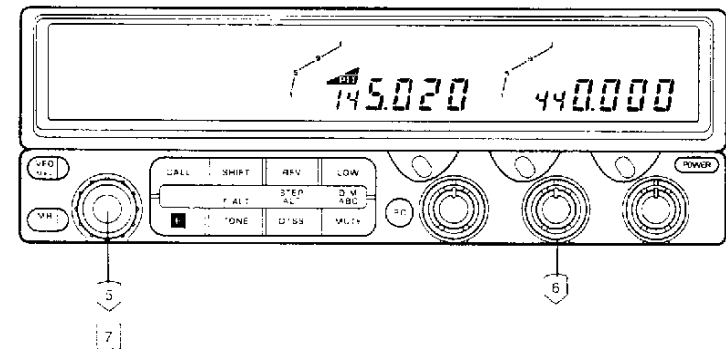

Note

When tuning above the transceiver band limit using the MHz key, digits to the right of the 100 kHz digit will always equal the same digits in the old frequency. However, the 100 kHz digit will place the new frequency within the first 100 kHz segment up from the lower band limit. Similarly, when tuning below the band limit, the new frequency will be within 100 kHz of the upper limit. This is also true when band limits have been customized using the programmable VFO feature (see page 52).



Squelch Basics

The squelch control position will affect receiver performance.

The chart below summarizes the characteristics of the squelch control settings.

Squelch Control Position	Advantages	Disadvantages
Constant background noise or signal.	Allows weak signal reception.	Constant noise can be fatiguing.
Background noise just disappears (threshold).	Weak signals can be heard without constant background noise.	Squelch is sometimes opened by unwanted very weak signals.
Control is advanced beyond the threshold.	No noise during periods of no signal.	Weak signals are not heard. Voice signals sometimes interrupted by excessive squelch adjustment.

Note
See page 28 for details on microprocessor controlled squelch.

Frequency Selection

- 7 Select an operating frequency using the **Tuning** control or the microphone **UP/DWN** keys.

You can also change the tuning step size(See page 51)

When a signal is received, the S-meter will deflect and the BUSY indicator will turn on.

You can change the dial frequency while in the VFO mode. The frequency can also be stored in memory, or in the call channel.

Mode selection

Use the **VFO**, **MR**, or **CALL** keys to select between these modes.

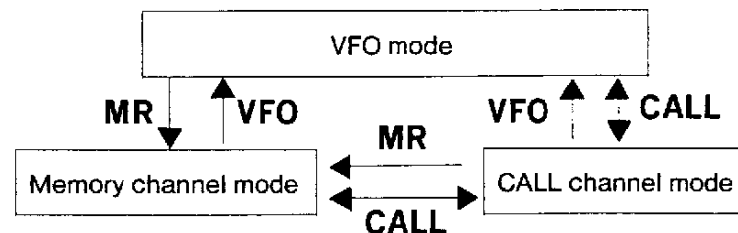

TRANSMITTER OPERATION

Caution

- 1 Before attempting to transmit, ensure that an antenna system with a low standing wave ratio (less than 1.5 SWR) is attached to the antenna connector. Attempting to transmit without an antenna or a dummy load can result in final amplifier damage.
- 2 High power and long transmissions increase the transceiver's temperature.

Note

- 1 When switching on the transceiver, wait until frequencies appear on the display after the word "ON" before pressing any function keys. Ignoring this procedure may initiate one of the functions that requires a key to be held down while turning on power.
- 2 Always check that the frequency is clear before transmitting.
- 3 Some combinations of transmit and receive frequencies might cause a reduction in receiver sensitivity.

- 1 Press the **BAND SEL** key to select the transmit band. The PTT indicator will light for the corresponding band. Bands in which the PTT indicator are not lit are used for reception only.
- 2 Select the transmit frequency using the Tuning control or the microphone **UP/DWN** keys.
- 3 Select the transmitter power output. Pressing the **LOW** key steps from high (no indicator displayed), to medium (M indicator displayed), to low (L indicator displayed), and back to high.

- 4 Press the **PTT** switch. The ON AIR indicator will light, and the RF meter will light.

- 5 Speak into the microphone. The recommended distance to the microphone is 5 cm (2 inches).

Note

Speak at the same volume as you would for a telephone conversation. Speaking too closely to the microphone may result in over deviation (distortion) of your transmit signal, which might be reported as a loss of clarity or an excessively wide transmit signal. Speaking too far away may result in a report of weak audio.

- 6 Release the **PTT** switch to return to the receive mode. The ON AIR indicator and the RF meter will switch off.

Simultaneous reception on the other bands is possible during transmission.

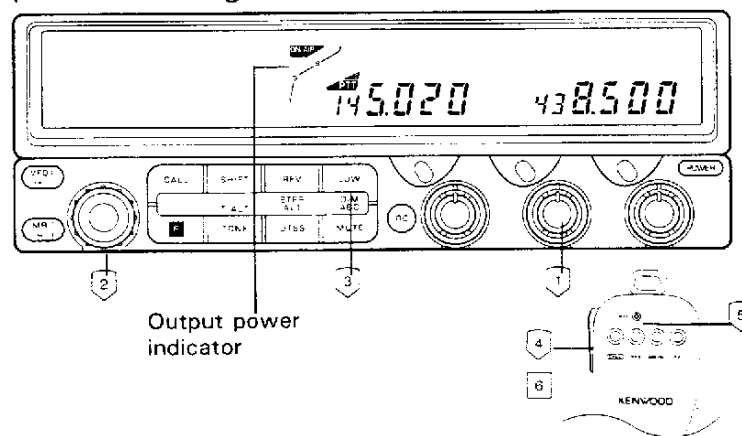

MEMORY BASICS

Memory Channels

The transceiver has 100 memory channels for each band.

Storing Information into Memory

Normal Repeater Offset or Simplex Channel Entry

- 1 Press the **VFO** key to select the VFO mode.
- 2 Select the receiver frequency, tone information etc. (For example 145.020MHz)
- 3 Press the **F** key momentarily. The F indicator will light, and a memory channel number will appear.
- 4 Select any memory channel using the **Tuning** control or microphone **UP/DWN** keys.
- 5 Press the **MR** key within 10 seconds of selecting the memory channel number. The F indicator and memory channel number will turn off. This signals that the data has been stored in memory.

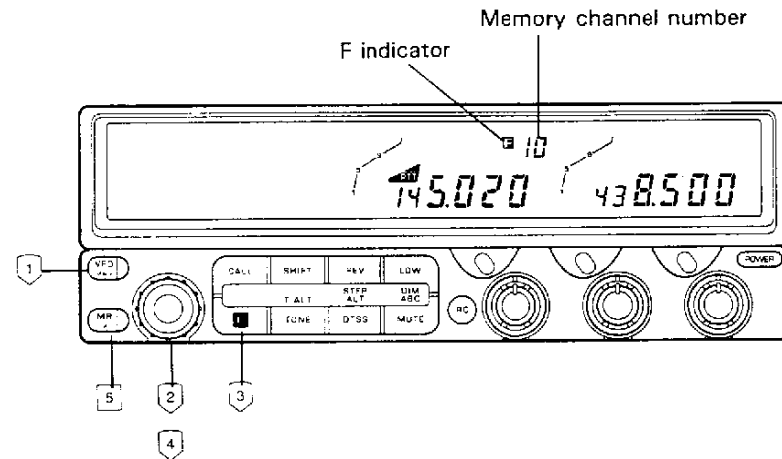

Note

A maximum of 10 seconds is allowed between each key entry. A longer pause than this results in the function self-canceling. You must then begin again.

Odd Split (non-standard frequency pair) Memory Channel

- 1 Press the **VFO** key to select the VFO mode.
- 2 Select the receiver frequency, tone information etc. (For example 145.020MHz)
- 3 Press the **F** key. The F indicator and memory channel number will appear.
- 4 Select any memory channel using the **Tuning** control or microphone **UP/DWN** keys.
- 5 Within 10 seconds of selecting the memory channel, press the MR key for longer than 1 second.
The $-+$ indicator illuminates to indicate the transmit frequency selection mode.
- 6 Select the transmit frequency.
- 7 Press the **MR** key.

Note

If the RX frequency is rewritten in an odd split channel, the TX frequency of the channel is automatically erased.

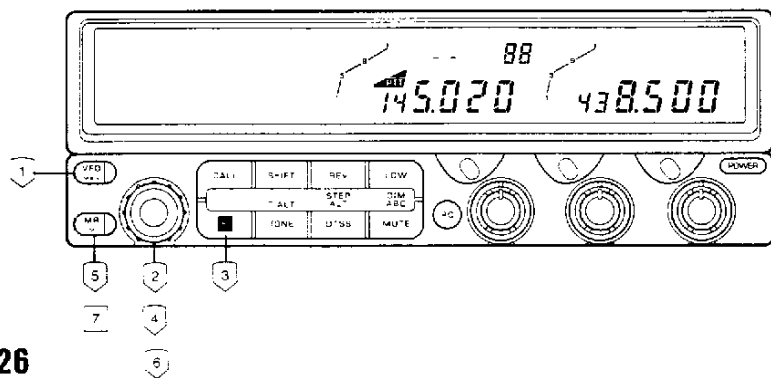

To confirm the contents of an odd split memory channel:

Press the **MR** key.

The programmed receiver frequency will appear in the display along with the $-+$ offset indicator, to remind you that this channel has an odd frequency split entered.

To check the transmit frequency press the **REV** key. The transmit frequency will appear in the display.

Memory Channel Recall

- 1 Press the **MR** key to select the memory mode. The last memory channel will light on the display.
- 2 Rotate the **Tuning** control or press the microphone **UP/DWN** keys to select the memory channel.

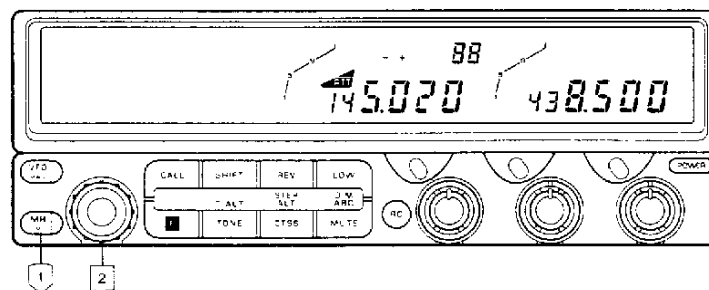

ADVANCED RECEIVE FUNCTIONS

A.B.C.(Automatic Band Change)

The ABC function allows you to exchange the receive band to the transmit band automatically whenever a signal is received and the squelch is open.

Press the **F** key, then press the **MUTE/ABC** key within 10 seconds. The ABC indicator will appear in the display.

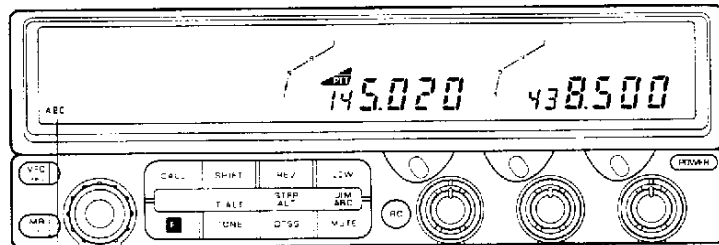

ABC indicator

As soon as a signal is received on any band, the transmit circuit will become active on that band.

Note

- 1 If you press the PTT switch, the ABC function will be canceled. That band remains transmit band.
- 2 If the PTT switch is not pressed within two seconds after the signal goes off, that band will be returned to receive band status.
- 3 Press the BAND SEL key to cancel the ABC function.

MUTE

When a signal is received on the transmit band, the receiver volume for the other band may be set to automatically mute. This allows the incoming signal to be heard more easily.

To select this function, press the **MUTE** key. The MUTE indicator will appear in the display.

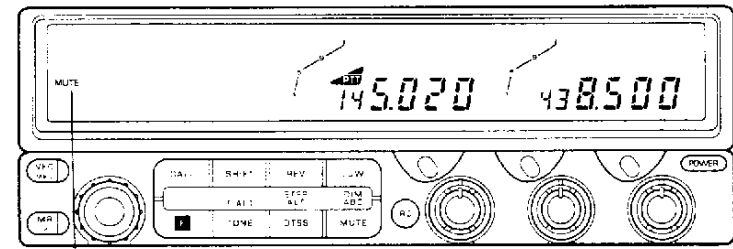

MUTE indicator

When a signal is received on the transmit band (with the PTT indicator), the volume for the other band is reduced.

To cancel this function, press the **MUTE** key again.

Note

You can still change the transmit band with the BAND SEL key during this function.

Microprocessor Squelch Control

Squelch operation may be controlled by the microprocessor to automatically select the squelch threshold without touching the SQL control. When this function is selected, you do not need to adjust the SQL control. This function can be set for each band.

- 1 Turn the **POWER** switch OFF.
- 2 Press and hold the **MHz** key (Tuning control), and press the **POWER** switch ON.
- 3 Press the **BAND SEL** key for the band in which the function is to be set.
- 4 Use the Tuning control to select a vacant frequency.
- 5 Press and hold the **MUTE** key for longer than one second.

This band is now set for microprocessor controlled SQL. To set another band, repeat steps 3 to 5.

To cancel microprocessor controlled squelch, switch the Power OFF and perform step 2.

Note

- 1 This function cannot be set if the **LOCK** function is ON.
- 2 Repeat steps 4 and 5 to reset the microprocessor squelch control. This may be necessary if a different antenna or operating location is used, for example.

S-Meter Squelch Control

The typical method of controlling squelch on a receiver is by detecting the reduction in the background noise level, or quieting, caused by the presence of a signal. This method is good, but does not allow precise threshold control. By changing to S-Meter squelch control you can set the squelch threshold so that it does not open until a specific S-Meter reading is obtained. This function can be set for each band.

- 1 Press the **BAND SEL** key for the band in which the function is to be set.
- 2 Turn the **POWER** switch OFF.
- 3 Press and hold the **LOW** key, and press the **POWER** switch ON.
- 4 Turn the SQL control to set the threshold level. You can check the setting with the S-meter indicator.

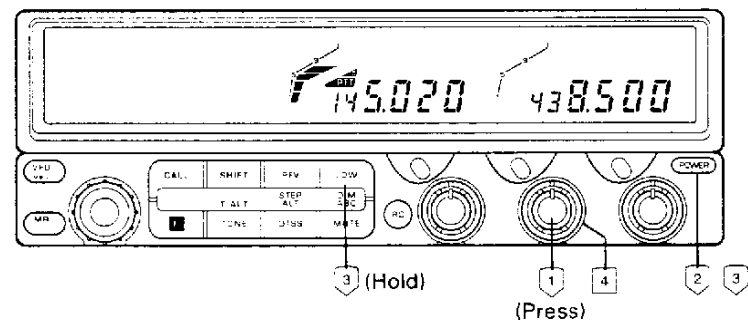

Repeat steps 1 to 4 for each band.

Repeat steps 2 and 3 to return to noise activated squelch.

In the S-Meter squelch mode, the time for the squelch to close is determined by a delay circuit. This is to prevent the squelch from closing during momentary signal dropouts. The factory preset is 500 milliseconds.

Note

- 1 You must deactivate microprocessor controlled squelch to program this function. Please refer to page 28, Microprocessor squelch control.
- 2 S-Meter Squelch cannot be used with CTCSS, DTSS, or Page.

To change the delay:

- 1 Press the **MUTE** key for longer than one second.
- 2 Select the delay time by turning the **Tuning** control. (OFF, 125, 250, or 500)
- 3 Press any front panel key to return to the normal display.

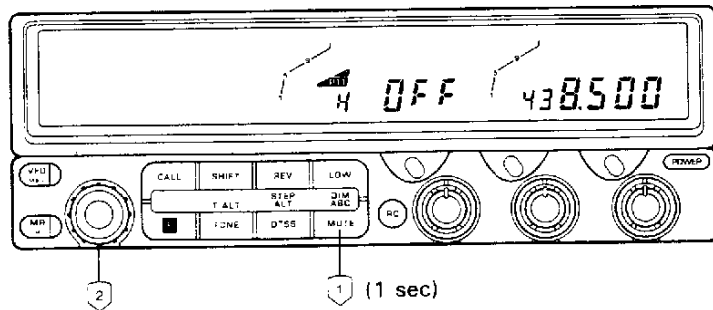

Attenuator ON/OFF

For the 28 and 50 MHz Bands (Requires an optional UT-28S or UT-50S BAND UNIT)

If the incoming signal is too strong, it can be attenuated to improve performance and reduce distortion.

- 1 Press the **C.SEL** key or the **BAND SEL** key for the 28/50MHz band.
- 2 First press the **F** key, and then press the **DTSS** key to toggle the **ATTENUATOR** function on or off. The attenuator indicator will turn on when the function is active.

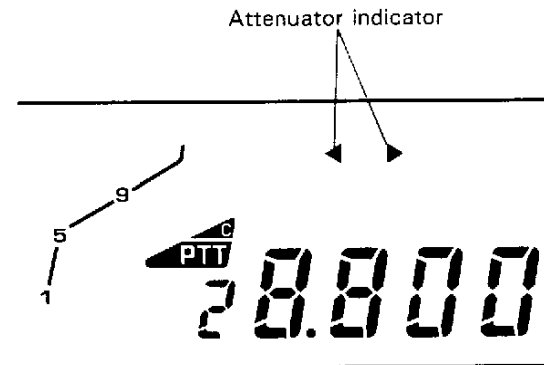

ALT (Automatic Lock Tuning)

1200MHz band only

The ALT system is similar to an AFC (Automatic Frequency Control). This system is useful if the frequency of either station drifts. When this occurs distortion is the usual result. The ALT system will detect the drift and automatically shift the frequency to compensate.

- 1 Press the **F** key. The F indicator will light.
- 2 While the F indicator is on, press the **DTSS/ALT** key. The ALT indicator will light and the receiver will automatically center itself on the incoming signal.

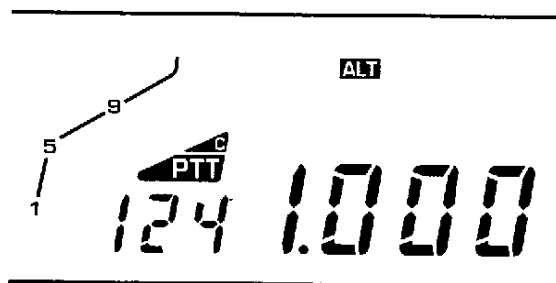

To release the ALT function, press the **F** key, then press the **DTSS/ALT** key.

The frequency display will not actually change, even though the receiver may shift frequency to tune the incoming signal.

When the ALT system is operating, the direction indicators will show if the incoming signal is higher or lower than the displayed frequency.

Illuminates when the transmit frequency of the other station is higher than your receive frequency.



Illuminates when the transmit frequency of the other station is lower than your receive frequency.

AM mode (U.S.A / Canada Version)

Selecting a frequency in the range from 118 MHz to 135.995 MHz automatically switches the transceiver to AM mode. "A" appears in place of the 100 MHz digit. To switch back to FM mode, hold down the MHz key for more than one second.

Receive Audio Output Band Selection (Microphone RD Terminal)

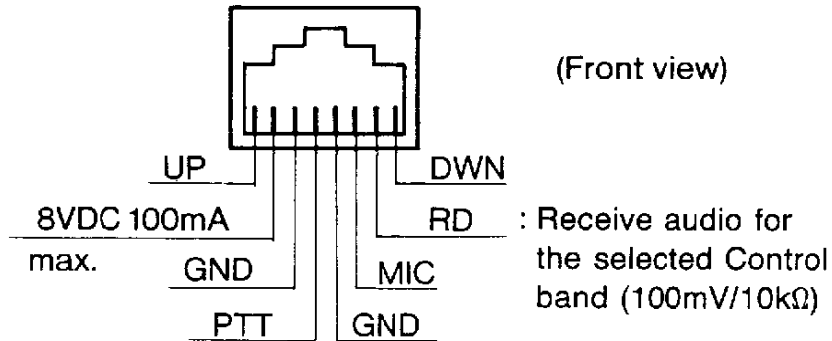

The receive audio for the control band can be assigned to the RD terminal.

Press the **F** key for longer than one second, and then press the **C.SEL** key for the selected band.

The 100 kHz decimal for that band will light.

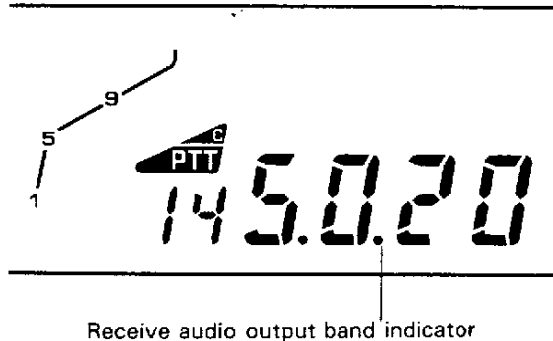

Repeat the same key sequence to return to the normal mode.

To use Packet, the transmit and receive frequencies should be the same (simplex). If you frequently use Packet, you may choose to Lock the Transmit Band. (See page 33.)

If RD output is not present for the control band, press the **BAND SEL** key. When RD output is locked to one band, pressing the **BAND SEL** key does not change the RD output band.

RD output squelch control

The RD output is present only when the squelch opens.

Turn the **POWER OFF**, press and hold the **TONE** key and press the **POWER** switch. The 10 kHz decimal lights when this function is selected.

Repeat the same key sequence to release this function.

ADVANCED TRANSMIT FUNCTIONS

Time-Out Timer (TOT)

The transceiver has a time-out timer function to prevent possible problems caused by continuous transmission. This function stops continuous transmission after a preprogrammed time interval.

The time-out interval is 3, 5, 10, 20, 30 minutes or OFF (no limit).
(The factory default is OFF.)

- 1 Press the **F** key for longer than one second.
- 2 The F indicator will begin to flash. Press the **LOW** key. The current Time-out time is displayed.
- 3 Select the time-out time by turning the **Tuning** control. The TOT indicator will light.
(If the time-out time is set to OFF, the TOT indicator will not light.)

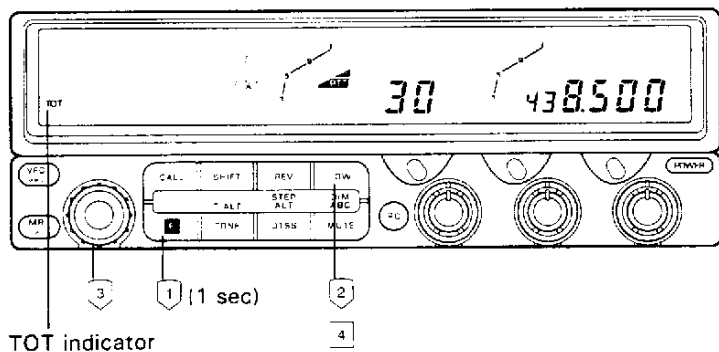

- 4 Press the **LOW** key. The Time-Out Timer is ON.

An alert tone sounds if the transceiver times-out during transmission. The transceiver reverts to the receive mode.

Release and then press the PTT switch to resume transmission.

Transmit Alert

A different confirmation tone sounds for each band when the PTT switch is pressed, to signal which band you are transmitting on.

Press the **PTT** switch while pressing the **F** key.

The transmit alert function is then turned on or off.

10M Transmit Bandwidth Selection

This is a feature of the UT-28 optional band unit. WIDE or NARROW bandwidth can be selected only on the 28 MHz band.

- 1 Turn the **POWER** switch OFF.
- 2 Press and hold the **F** key and the **LOW** key, then turn the **POWER** switch ON.

This will toggle the transmit bandwidth between WIDE and NARROW. When NARROW is selected, "n" will appear to the left of the frequency display.

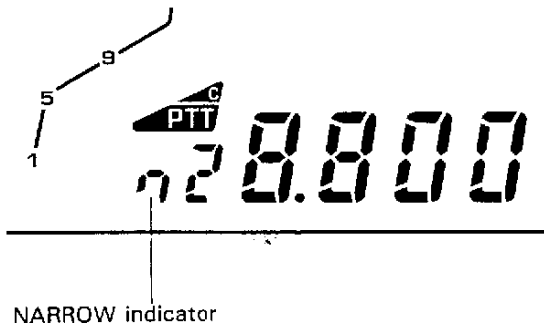

Locking the Transmit Band

The transceiver may be locked to prevent an accidental transmit band change.

When the transmit band is locked, no other band can be selected as the transmit band. The other bands will only receive.

- 1 Turn the **POWER** switch OFF.
- 2 Press and hold the **BAND SEL** key and turn the **POWER** ON.

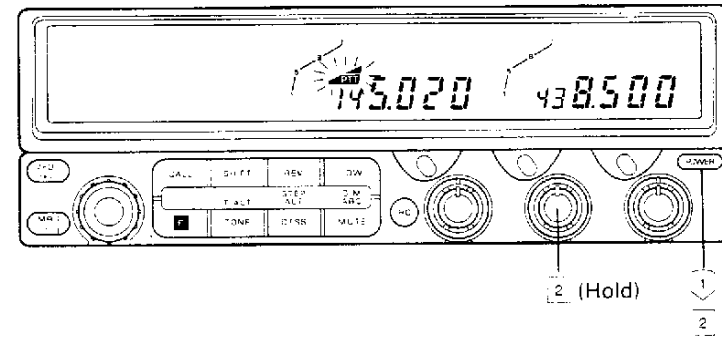

The PTT indicator for the selected band will flash continuously.

To cancel the Lock, repeat these two steps.

Note
The receiver audio output (RD) at the microphone connector will also be locked to this band.

MEMORY

Microprocessor Memory Back-up

This transceiver contains a lithium battery to retain memory. Turning off the POWER switch, disconnecting the power cable or an intermittent power failure will not erase the memories. The battery life is estimated at 5 years. When the battery becomes depleted, erroneous information might appear on the display.

Lithium battery replacement should be performed by an authorized KENWOOD service facility, or your authorized KENWOOD dealer. This equipment contains CMOS circuitry and can be damaged by improper replacement procedures.

Microprocessor Defaults

	VFO, Call channel and Memory channel 1 frequency	Frequency step	Tone frequency
144 MHz	144.000 MHz	5 kHz/12.5 kHz	88.5 Hz
220 MHz	220.000 MHz	20 kHz	88.5 Hz
440/430 MHz	440.000 MHz 430.000 MHz	25 kHz	88.5 Hz
1200 MHz	1240.000 MHz	25 kHz	88.5 Hz

Reset (Microprocessor Initialization)

The transceiver provides a separate Memory reset and VFO reset for each band independently, or all bands simultaneously.

Note

- 1 Do not stop resetting halfway. Complete all reset steps.
- 2 If the display should show erroneous information after initialization, reset the transceiver a second time.

ALL BAND Memory Reset

All the user programs, except the clock, are reset.

- 1 Turn the **POWER** switch OFF.
- 2 Press and hold the **MR** key and turn the **POWER** ON. After one second all the LCD indicators will light.

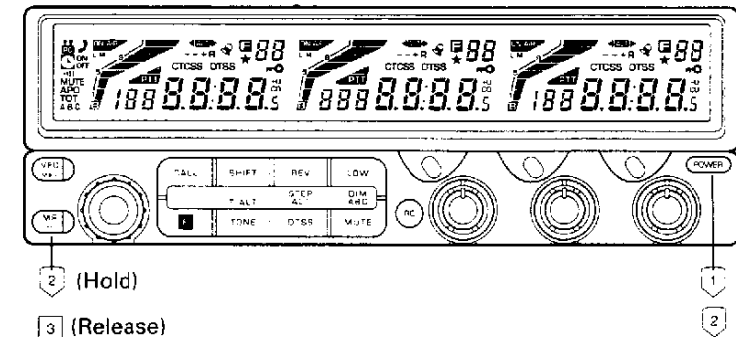

- 3 Release the **MR** key.

INDIVIDUAL BAND Memory Reset

- 1 Turn the **POWER** switch OFF.
- 2 Press and hold the **F** key and the **BAND SEL** key (for the selected band), then press **POWER ON**. After one second all the LCD indicators for the band will light.
- 3 Release both keys.

ALL BAND VFO Reset

All VFO memories (without memory channels 1~100 and the CALL channel) will be initialized.

- 1 Turn the **POWER** switch OFF.
- 2 Press and hold the **VFO** key and press **POWER ON**.
- 3 Release the **VFO** key.

INDIVIDUAL BAND VFO Reset

- 1 Turn the **POWER** switch OFF.
- 2 Press and hold the **VFO** key and the **BAND SEL** key (for the selected band), then press **POWER ON**.

- 3 Release both keys.

Memory Contents

Each memory channel is capable of storing the following information:

	Normal channel	Odd Split channel
RX Frequency	YES	YES
TX Frequency	NO	YES
Tone/CTCSS Frequency	YES	YES
Tone (CTCSS) status	YES	YES
Frequency step	YES	YES
Shift status (*)	YES	NO
REV status (*)	YES	NO
DTSS code ,DTSS status	YES	YES
Last operation paging memory number	YES	YES

YES : Can be stored in Memory.

NO : Cannot be stored in Memory.

(*) When a separate transmit frequency is entered in a memory, the shift state and reverse on/off programming is removed from the memory.

Rewriting Call Channel Data

- 1 Press the **VFO** key to select the VFO mode.
- 2 Select or enter all the Call Channel data.
- 3 Press the **F** key. The F indicator and the memory channel indicator will both light.
- 4 Press the **CALL** key within 10 seconds of pressing the F key to enter the new data into memory.

If you wish to enter a split frequency in a Call Channel, perform these additional steps, after step three:

- 4 Press the **CALL** key for longer than one second within 10 seconds of selecting the memory channel number. The **- +** indicator shows the TX frequency selection mode.
 - 5 Select the desired transmit frequency.
 - 6 Press the **CALL** key.
- To check the transmit frequency press the **REV** key. The transmit frequency will be displayed.

Memory Banks

The memories are divided into five banks of 20 channels each.

BANK 1:	CH	1	~ 20
BANK 2:	CH	21	~ 40
BANK 3:	CH	41	~ 60
BANK 4:	CH	61	~ 80
BANK 5:	CH	81	~ 100

If you store your channel data in the memory banks by their logical function, you can select the type of scan for each function. (See page 43.) You can also link memory banks.

Memory Bank link

Adjacent banks may be linked and used as one large bank, or all banks can be linked.

Example : Link bank 1 to bank 2

- 1 Press the **F** key. The F indicator will light.
- 2 Display the highest channel number 20 of the lower bank using the **Tuning** control or the microphone **UP/DWN** keys.
- 3 Press the **C.SEL** key to link with the higher adjacent bank.

<i>Memory Banks</i>	<i>Select Memory Channel to Link Banks</i>	<i>Select Memory Channel to Separate Banks</i>
1, 2	Ch 20	Ch 21
2, 3	Ch 40	Ch 41
3, 4	Ch 60	Ch 61
4, 5	Ch 80	Ch 81

Link status check

- 1 Press the **C.SEL** key to select the operating band.
- 2 Press the **MR** key to enter the memory channel mode.
- 3 Press the **TONE** key while pressing the **F** key. The bank status will be displayed.
- 4 Turn the **Tuning** control or press the microphone **UP/DWN** keys to review the bank link status.

Example
Banks 1 and 2 are linked.

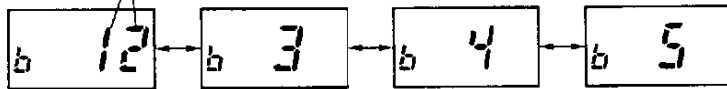

- 5 Wait for 10 seconds or press any of the front panel keys to return to the normal frequency display mode.

Separating linked memory banks

Example : Separate bank 1 from bank 2.

- 1 Press the **F** key. The F indicator will light.
- 2 Display the lowest channel number 21 of the higher bank using the **Tuning** control or microphone **UP/DWN** keys.
- 3 Press the band **C.SEL** key to separate the banks.

Memory Consolidation

The memory channels may be rewritten to optimize memory scan operation. This is an advantage if there are many open channels separating those channels that contain data. Memory consolidation causes the active memory channels to be rewritten sequentially from the lowest channel, without blank channels in between. The following two diagrams illustrate this function.

Example

Data is currently stored in memory channels 1, 5, 8, 12, 15, 19, and 20.

Before consolidation

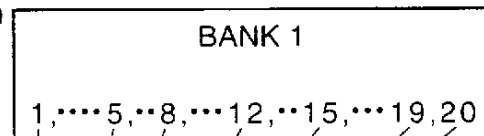

After consolidation

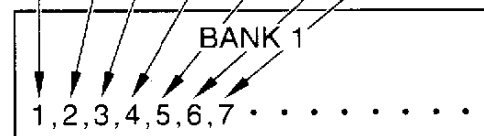

- 1 Press the **BAND SEL** or **C.SEL** key for the band you wish to consolidate.
- 2 Press the **MR** key to enter the memory channel mode.
- 3 Select any memory channel within the bank you wish to consolidate.
- 4 Press and hold the **F** key and then press the **LOW** key.

A tone will sound to signal that memory consolidation is finished. The display will change to show the total number of active memory channels after consolidation.
- 5 To check memory consolidation in the other banks, you can rotate the **Tuning** control, or step through the memory banks with the microphone **UP/DWN** keys. A relative indication of memory channel usage for the bank will show on the S-Meter.
- 6 To return to the normal frequency display, wait 10 seconds or press any front panel key.

Clearing Memory

Clearing a memory channel

- 1 Select the channel to be cleared.
- 2 Simultaneously press the **F** key and the **MR** key.
The memory channel will be cleared, and the display will indicate the next active memory channel.

Clearing a memory bank

- 1 Select any channel in the bank that you wish to clear.
- 2 Simultaneously press the **F** key and the **BAND SEL** key.

All channels in the selected bank will be cleared. The next active memory channel will be displayed.

Note

- 1 *Memory channel 1 cannot be cleared by either of these two methods.*
- 2 *If banks are linked, only the displayed bank is cleared.*

Memory Shift

This function copies the contents of a memory channel or call channel to the VFO without changing the data in memory. This will allow you to begin tuning or change specific settings at the point originally defined by the memory channel data.

- 1 Press the **MR** key, then select a memory channel.
- 2 Press the **F** key.
- 3 Within 10 seconds of pressing the **F** key, press the **VFO** key to copy the data.

SCAN

Each band can be scanned independently. The squelch must be set. (See the chart, page 23). Scan cannot be used in conjunction with the Tone Alert function.

Note

- 1 *When CTCSS is operating, scan will stop only on a signal with the preselected subaudible tone.*
- 2 *With DTSS operating, scan will stop (with the squelch turned off) whenever a signal is received. Squelch will not open, however, until the preselected DTSS tone codes are received.*
- 3 *When both CTCSS and DTSS are on, scan will stop when the proper CTCSS tone is received. Squelch will then open only if the DTSS code matches when scan stops.*

Scan Options

The following scan options are provided:

Band Scan

Scan proceeds over the entire band. This function operates only in the VFO mode.

Programmable Band Scan

The scan range in this mode is specified in memory .

MHz Scan

Scans over a 1 MHz range.

Memory Scan

Scan proceeds through those memory channels in a band or in a bank that contain data and have not been locked out. This function operates in the memory mode only.

CALL / VFO Scan

Alternate scanning between the call channel and the VFO.

CALL / Memory Scan

Alternate scanning between the call channel and the memory channel that was last used.

V/M/C (VFO/Memory/Call) Scan

Scans the VFO, the memory channel last used, and the call channel.

Auto Memory Scan

Scans the band scan range. Any frequency that the transceiver stops on for more than one second is memorized in an empty channel in bank 5.

Hold/Resume Programming

Two types of scan hold and resume have been provided in this transceiver. Each band can be set differently.

Time Operated Scan (TO)

Scan stops on a busy channel, remains there approximately 5 seconds, and then continues to scan even if the signal is still present.

Carrier Operated Scan (CO)

Scan stops on a busy channel and remains there until the signal drops out. The radio waits two seconds before scan resumes to prevent moving on before either you, or the next station transmits.

The radio is delivered from the factory in the Time Operated Scan mode. To switch between modes, use this procedure.

- 1 Press the **F** key for longer than one second. The F indicator will flash.
- 2 While the indicator is flashing, press the **VFO** key. This will toggle the Hold / Resume mode to the Carrier Operated mode, and the CO indicator will light.

To return to Time Operated mode repeat steps 1 and 2.

Band Scan

- 1 The squelch must be set. (See the chart, page 23).
- 2 Press and hold the **C.SEL** key for longer than one second (for the VFO mode). The operating band changes at the same time.
- 3 Scan will begin. The MHz decimal and the **C.SEL** indicators will blink.
Scan will begin in an upwards direction. The direction can be reversed by turning the **Tuning** control or by pressing the microphone **UP/DWN** keys. The frequency step size determines the tuning step size.
Scan will stop on a busy channel if there is a station strong enough to open the squelch and turn on the BUSY indicator.
- 4 To stop scanning, press the PTT switch. All bands can be scanned at the same time by repeating steps one through three for each of the other bands. Scan will stop only on the band(s) that receive a signal. The other band(s) will continue to scan.

Programmable Band Scan

The lower and upper frequency limits for programmable band scan are set in advance for each band. The lower frequency limit step size determines the scan step size.

Scan Limit Entry

In the following example, a lower frequency limit of 145.100 MHz and an upper frequency limit of 145.600 MHz are set.

- 1 Select the 144 MHz band with the **BAND SEL** or **C.SEL** key.
- 2 Press the **VFO** key.
- 3 Press and hold the **F** key, then press the **VFO** key.
- 4 Select 145.100 MHz with the **Tuning** control or the microphone **UP/DWN** keys. **PL** indicates this will be the lower frequency limit.

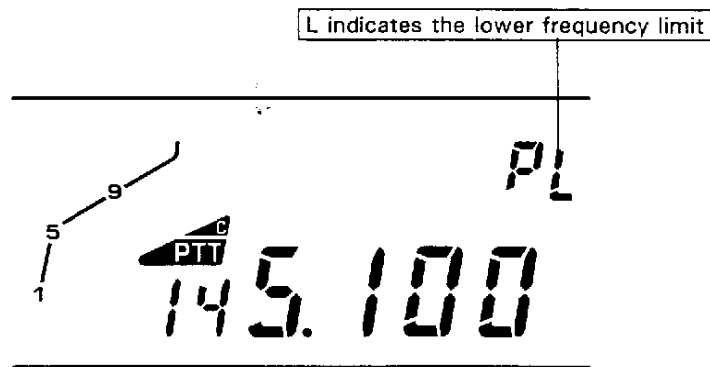

- 5 Press the **MR** key.

- 6 Select 145.600 MHz with the **Tuning** control or the microphone **UP/DWN** keys. **PU** indicates this will be the upper frequency limit.

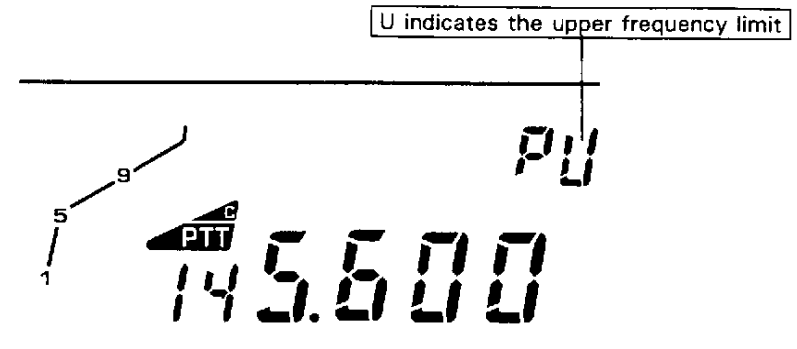

- 7 Press the **MR** key. The programmable band scan setting for 144 MHz is finished. If you wish to store other data in memory for the other bands repeat steps 1 through 7.

Confirmation of the Scan Range

- 1 Press the **VFO** key.
- 2 Press and hold the **F** key, then press the **VFO** key. The **PL** indicator appears in the memory channel display area.
- 3 Press the **MR** key. **PU** replaces **PL** in the memory channel display area.
- 4 Press the **MR** key. The memory channel area clears.

Operation

- 1 Select a frequency between the two programmed scan limits. If you select a frequency outside the programmed limits, the transceiver will perform normal band scanning.
- 2 Press the **VFO** key for longer than one second. The MHz decimal will flash as a reminder the transceiver is scanning.

Note

If the current frequency step is different from the upper and lower limit frequency steps, the scan begins at the lower limit, therefore step size is determined by the lower frequency limit.

MHz Scan

Press the **Tuning** control during band scan or programmable band scan.

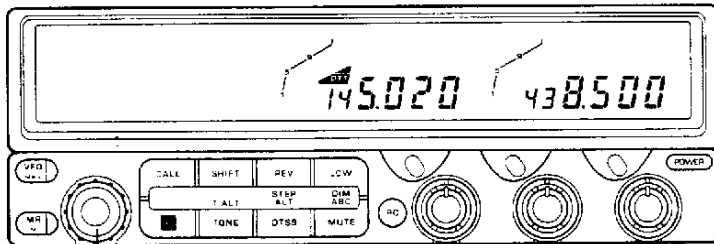

Press

Memory Channel Scan

Notes

- 1 Only those memory channels with data and that have not been locked out will be scanned.
- 2 Scan cannot start unless there are at least two channels with data entered.

The memory in a band and in a bank can be scanned.

Memory scan in band

- 1 Press the **C.SEL** key or the **BAND SEL** key to change the operating band.
- 2 Press the **MR** key for longer than one second to start memory scan for that band.

Memory scan in bank

- 1 Press the **MR** key to select the memory channel mode.
- 2 Press the **C.SEL** key for longer than one second to start memory bank scan.

Locking Out Memory Channels

Memory channels may be selectively skipped during memory channel scan.

- 1 Press the **MR** key to select the memory channel mode.
- 2 Select a memory channel to be skipped with the **Tuning** control or the microphone **UP/DWN** keys.
- 3 Press and hold the **F** key for longer than one second, then press the **MR** key.
A ★ indicator will appear to the left of the memory channel number. This shows the memory channel will be skipped during memory channel scan.



To lock out any other channels, repeat steps 2 and 3. To cancel a lock out, repeat steps 1 through 3 for that channel.

The ★ indicator will turn off.

CALL/VFO Scan

- 1 Press the **C.SEL** key or the **BAND SEL** key to select the operating band.
- 2 Press the **CALL** key for longer than one second in the VFO mode to start scanning between the VFO frequency and the Call Channel.

CALL/Memory Channel Scan

- 1 Press the **C.SEL** key or the **BAND SEL** key to select the operating band.
- 2 In the memory channel mode, press the **CALL** key for longer than one second to start scanning between the Call Channel and the last used memory channel.

V/M/C (VFO/Memory/Call) Scan

- 1 Press the **C.SEL** key or the **BAND SEL** key to select the operating band.
- 2 In the CALL Channel mode press the **C.SEL** key for longer than one second to scan the VFO frequency, the last used memory channel, and the Call Channel.

Automatic Memory Scan

The transceiver will search for active channels. When a signal lasts for more than one second, that frequency will be sequentially written into memory bank 5 open channels, as shown.

- 1 Press the **VFO** key to select the VFO mode.
- 2 Press and hold the **F** key, then press the **C.SEL** key to select the band to scan.
- 3 Release both keys.

The transceiver will "beep" each time a frequency is entered into memory. Scan will stop after all of the open bank 5 memory channel positions are filled.

Note
When bank 5 is linked with adjacent banks, memory storage begins in the lowest order bank.

Bank 5 memory status before auto memory scan

81	
82	
83	145.100 DTSS
84	145.200
85	
.	
.	
98	145.300 CTCSS

Bank 5 memory status during auto memory scan

81	145.010
82	145.020
83	145.100 DTSS
84	145.200
85	145.055
.	
.	
98	145.300 CTCSS

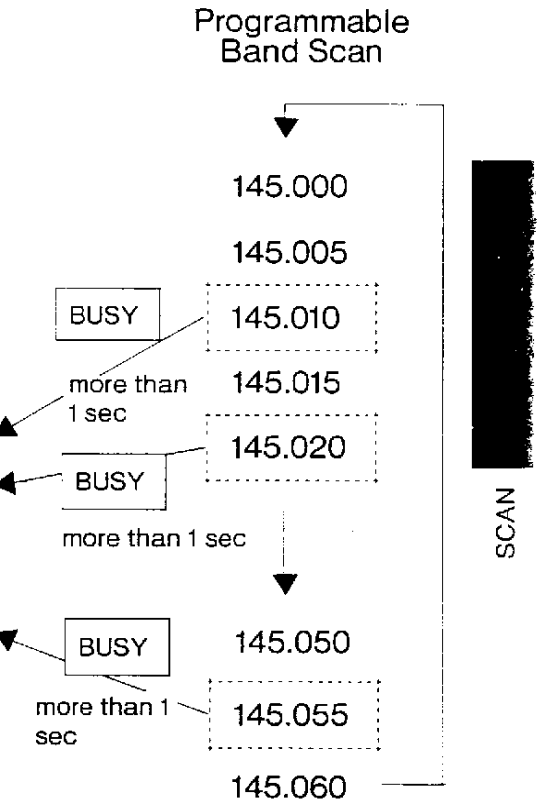

REPEATER OPERATION

Transmitter Offset

Repeaters use a separate receive and transmit frequency. The receive frequency may be above or below the transmit frequency. The configuration of most repeaters falls into one of the categories listed below:

	144 MHz	220 MHz	440 MHz
+	+ 600 kHz	+ 1.6 MHz	+ 5 MHz
-	- 600 kHz	- 1.6 MHz	- 5 MHz
--			

	430 MHz (E type only)	1200 MHz	1200 MHz (E type only)
+	+ 1.6 MHz	+ 12 MHz	+ 35 MHz
-	- 1.6 MHz	- 12 MHz	- 6 MHz
--	- 7.6 MHz	- 20 MHz	

Selecting the Offset Direction

To manually select the transmitter offset direction, press the **SHIFT** key. The transceiver advances from one direction to the next, "+" to "-" or "-" to "--", to no offset (simplex).

Automatic Offset

U.S.A./Canada version

The transceiver has been programmed to the ARRL (American Radio Relay League) standard band plan for transmitter offset direction. The chart illustrates this programming. This may be manually overwritten by using the **SHIFT** key, if required.

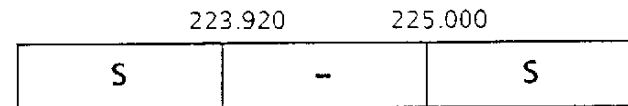
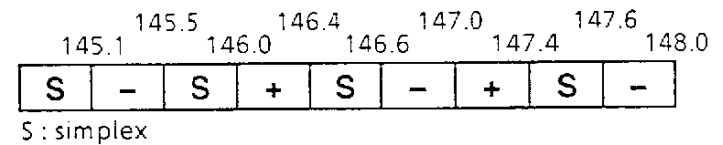

Europe version

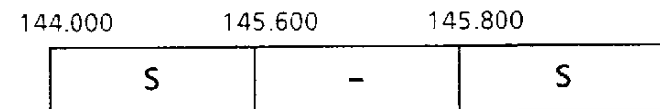

To cancel automatic offset

- 1 Turn the **POWER** switch off.
- 2 Press the **VFO** and **REV** keys, and press the **POWER** switch ON.

This toggles the Automatic Offset mode on or off.

Reverse Function

Some repeaters use a "Reverse Pair", i.e. the transmit and receive frequencies are the reverse of other repeaters.

For example, repeater A receives at 146.0 MHz , the "Input" (your transmit frequency). Its "Output" is at 146.6 MHz (your receive frequency). In some other geographic areas, Repeater B might use 146.0 MHz for a transmit frequency and 146.6 MHz for a receive frequency.

It would be inconvenient to reprogram the transceiver each time to use these repeaters. The REV key allows easy reversal of the transmit and receive frequencies.

Press the REV key to use this function. The R indicator comes on to indicate you have selected a reverse pair.

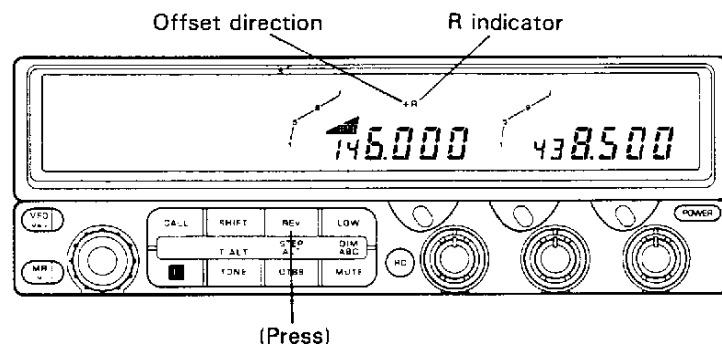

To return to normal, press the **REV** key again. The R indicator goes off.

This function is also useful to check the input frequency of a repeater, to determine if you and your contact are within simplex communications range. If you are able to hear each other directly, without need of the repeater, you may switch to another open frequency for simplex communications. This is courteous to the other repeater users, and reduces crowding on the repeater. It is also practical, since the repeater may remain available for others to use.

Tone Operation

Some repeaters require a control signal to be activated. Several different methods are currently used.

In the United States, subaudible tones are the usual method of control. This transceiver will generate standard subaudible tones.

Europe version only

In Europe and the United Kingdom, a 1750 Hz tone is used to access the repeater. Press and hold the **1750** key to transmit the access tone. You need not press the PTT switch. (MC-45E)

Selecting Tone Frequencies

A tone frequency can be independently selected for each band.

- 1 Press the **F** key for longer than one second. The F indicator will flash.
- 2 Press the **TONE** key. The current tone frequency will show in the display.

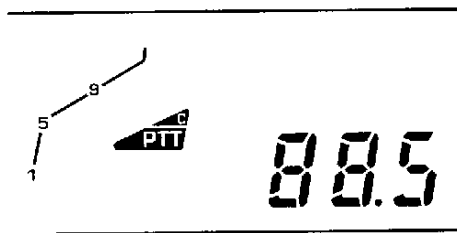

- 3 Use the **Tuning** control or press the microphone **UP/DWN** keys to select a tone frequency.

Tone Frequency (Hz)

67.0	82.5	97.4	114.8	136.5	162.2	192.8	233.6
71.9	85.4	100.0	118.8	141.3	167.9	203.5	241.8
74.4	88.5	103.5	123.0	146.2	173.8	210.7	250.3
77.0	91.5	107.2	127.3	151.4	179.9	218.1	
79.7	94.8	110.9	131.8	156.7	186.2	225.7	

- 4 After the tone frequency is selected, the previous mode will be resumed 10 seconds after selection or when any front panel key is pressed.

Tone Function Operating

Press the **TONE** key. A "T" indicator appears on the display, and the transmitter sends the desired tone when the PTT switch is depressed.

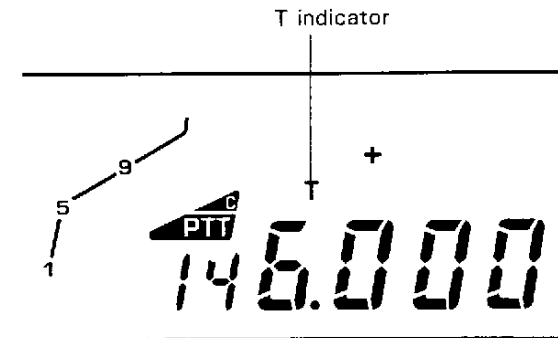

Autopatch Operations

(U.S.A./ Canada version only)

Some repeaters offer a service known as autopatch. This allows you to connect into the local commercial telephone system, dial a telephone number from your transceiver, and carry out a telephone conversation, similar to a car telephone. This requires using a DTMF (Dual Tone Multi-Frequency) pad.

The DTMF microphone (MC-45DM/DME) provides the usual numeric, * and # keys found on home telephones, and also provides the four additional, A, B, C and D keys. These are sometimes used in a repeater system for control functions. The repeater control operator can inform you of dialing codes and operating procedures used on the system.

To activate the keypad:

- 1 Press and hold the **PTT** switch.
- 2 Press the numeric keys as you would dial your home telephone.

The transceiver will remain keyed for approximately two seconds after you press each number, so you can release the PTT switch after the first digit is dialed without exiting transmit.

Note

Some repeaters will require the use of a special key sequence to activate the autopatch function. You should check with your control operator for this sequence.

DTMF (dialer) Memory

A total of 16 (telephone) DTMF numbers (up to 15 digits) can be entered into memory.

To store a telephone (DTMF) number

- 1 Press and hold down the **F** and **CALL** keys, then switch the **POWER ON**.
A **P - - -** appears in the display.



- 2 Enter the telephone (DTMF) number, up to 15 digits, using the keypad on the microphone.

The number is displayed from the right; when more than four digits are displayed, the first digit scrolls to the left.

- 3 If you enter an incorrect digit, press the microphone VFO key, and start over. After the number has been entered, press the microphone PF key. The display changes to **P - XXX**.



- 4 Press a numeric key from 0 through 9, or an A through D letter key, or either the # or * for the DTMF dialer memory channel in which the number is to be stored.

P — — — reappears on the display.

- 5 To store other telephone numbers in the dialer memory, repeat steps 2 through 4.

To cancel the setting, press the PTT.

Note

If DTMF audio from other equipment is picked up by your microphone while you are entering DTMF digits, digits corresponding to the interfering DTMF audio may be entered instead of the digits entered on your keypad.

DTMF dialer memory verification before transmission

- 1 Press and hold the **F** and **CALL** keys, then switch the **POWER ON**.
- 2 Press the microphone **MR** key.
- 3 Press the numeric, symbol, or letter key for the DTMF dialer memory channel to be verified. The numbers stored in memory are displayed sequentially in the frequency display, and the DTMF tones sound.
- 4 To check other dialer memories, repeat steps 2 and 3. To cancel the setting, press the PTT.

Transmitting stored telephone numbers from the dialer

- 1 Press the **BAND SEL** key to select the band.
- 2 Select the transmit frequency using the **Tuning** control or the microphone **UP/DWN** keys.
- 3 Press and hold the **PTT** switch, then press the microphone **PF** key. The P indicator lights, and the receive mode returns automatically. Release the PTT key.
- 4 Select the DTMF dialer memory channel number with the numeric keypad.

Transmit mode begins, and the telephone number is sent. Then, the transceiver automatically returns to receive.

Note

Transmission continues until the entire telephone number is sent, even if the PTT switch is released. The DTMF dialer sequence runs until completed.

OTHER USEFUL FUNCTIONS

Frequency Step Selection

To select the desired tuning or scan step size:

- 1 Press the **C.SEL** key or the **BAND SEL** key to select the band.
- 2 Press the **VFO** key to select the VFO mode.
- 3 Press the **F** key. The F indicator will appear.
- 4 Press the **REV/STEP** key within 10 seconds of pressing the F key. The current frequency step size will be displayed.
- 5 Use the **Tuning** control or the microphone **UP/DWN** keys to select a new tuning step size.

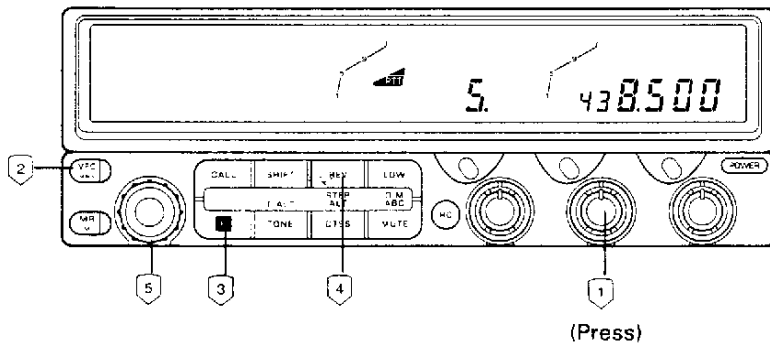

Step Size by band [displayed in kHz]

144 MHz, 220 MHz, and 430/440 MHz band

$5 \Rightarrow 10 \Rightarrow 15 \Rightarrow 20 \Rightarrow 12.5 \Rightarrow 25 \Rightarrow 5 \Rightarrow \dots$

1200 MHz band

$10 \Rightarrow 20 \Rightarrow 12.5 \Rightarrow 25 \Rightarrow 10 \Rightarrow \dots$

- 6 To return to the normal frequency display, press any front panel key or wait 10 seconds.

The following chart illustrates the resulting frequency change for a step change.

5,10,15,20 to 12.5,25		12.5,25 to 5,10,15,20	
0,5,10,15	0	0	0
20,25,30,35	25	12.5	10
40,45,50,55	50	25	20
60,65,70,75, 80,85,90,95	75	37.5	30
		62.5	60
		75	70
		87.5	80

For example:

If a frequency of 439.920 MHz with a 20 kHz step size is displayed, and you change the step size to 12.5 kHz, the display will then read 439.925 MHz.

Programmable VFO Tuning Limit

The radio allows programming the VFO tuning range, in 100 kHz band segments, besides providing a separate Programmable Band Scan function. (See page 42)

For example, to tune the 145.100 MHz through 145.500 MHz band segment, specify the frequency range with these two limits.

The **Tuning** control or **UP/DWN** keys will then tune only within this specific band segment.

The procedure is as follows:

- 1 Press the **C.SEL** key or **BAND SEL** key to select the band.
- 2 Press the **VFO** key to select the VFO mode.
- 3 Press the **F** key, for longer than one second, then press the **CALL** key.

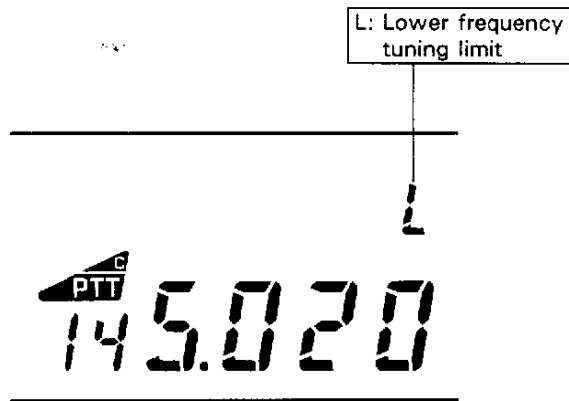

- 4 Tune to the lower frequency tuning limit. (Example: 145.100 MHz)

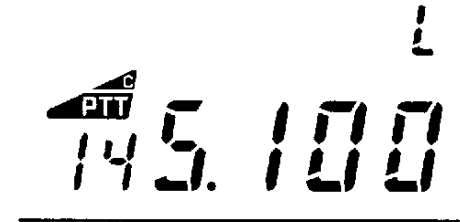

- 5 Press the **MR** key.

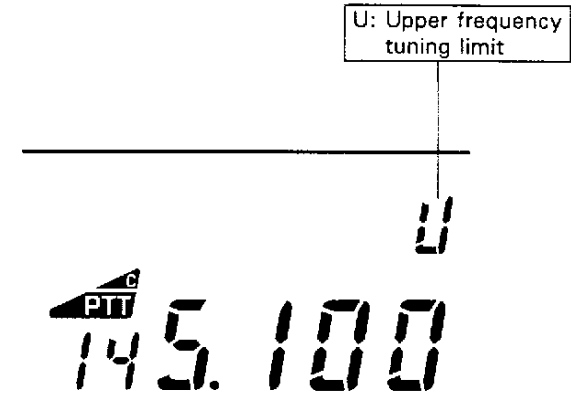

- 6 Tune to the upper frequency tuning limit.
(Example: 145.500 MHz)

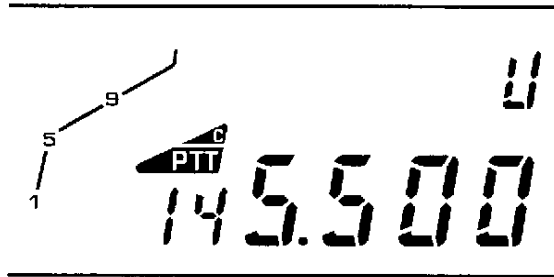

- 7 Press the **MR** key.
ON or OFF displays.
(Example: OFF)

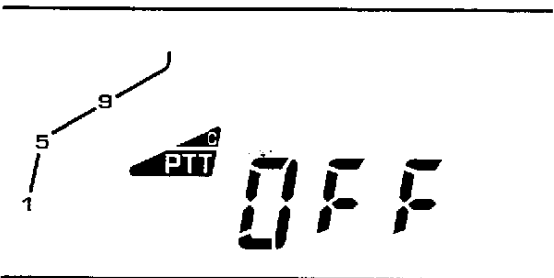

- 8 If OFF appears, select ON with the **Tuning** control.

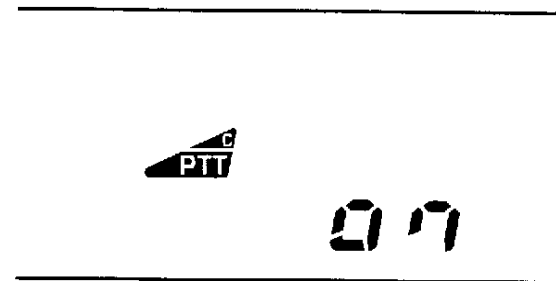

- 9 Press the **MR** key.
To confirm this programming, rotate the **Tuning** control.
The transceiver will not go above or below the programmed band segment limits.
Either limit can be independently reprogrammed using these same instructions.

Note
If you select OFF in step eight, the programmable VFO tuning limit function is canceled.

Microphone Key Functions : Custom Reassignment

The PF, CALL, VFO, and MR keys can be reassigned to perform other functions.

To program the key use the following procedure:

- 1 Turn the transceiver **POWER** switch OFF.
- 2 Press and hold the key which is to be reassigned.
- 3 Turn the **POWER** switch ON. PF1, 2, 3, or 4 will be displayed.

<i>Microphone key</i>	<i>Display</i>
PF	PF-1
MR	PF-2
VFO	PF-3
CALL	PF-4

- 4 Press the key on the front panel whose function is to be assigned to that microphone key.
These functions can be assigned to the microphone keys:
 - Front panel key functions
 - Functions activated using the F key, then a front panel key within 10 seconds

- Functions activated by depressing the F key for longer than one second, and then a front panel key within 10 seconds

- Functions activated by depressing the F key + a front panel key

To cancel a Microphone Function Key custom reassignment, perform the ALL BAND Memory Reset (See page 34) or reassign the original function following steps 1 through 4 above.

MONITOR and ENTER

Two additional functions can be custom assigned which are not available on the transceiver front panel.

These are the MONITOR and ENTER functions.

The MONITOR function allows you to check that the frequency is clear before transmitting, regardless of the squelch mode.

The ENTER function allows direct frequency entry using the DTMF keypad on the microphone.

MONITOR programming

- 1 Press and hold the **F** key and turn the **POWER** switch ON.
- 2 Select PF1 to PF4 using the **Tuning** control.
- 3 Press the **MR** key. The MONITOR function is assigned now to the microphone key associated with the PF key selected in step 2.

ENTER programming (DTMF microphone only)

- 1 Turn the **POWER** switch OFF.
- 2 Press and hold both the **F** key and the **VFO** key, and turn the **POWER** switch ON.
- 3 Select a key (using its PF number) with the **Tuning** control. (Microphone key names and corresponding PF numbers are listed on page 54.)
- 4 Press the **MR** key.

The ENTER function is now assigned to that microphone key.

- 5 To enter a frequency directly, from the microphone, press the assigned ENTER key, then enter the frequency using the microphone DTMF pad.

Note
If DTMF audio from other equipment is picked up by your microphone while you are entering a frequency, digits corresponding to the interfering DTMF audio may be entered instead of the digits entered on your keypad.

Beep Tone Frequencies

This function can be assigned to the microphone PF, MR, VFO, or CALL key.

- 1 Turn the **POWER** switch OFF.
- 2 Press and hold the **F** key, and the **DTSS** key, and turn the **POWER** switch ON.
- 3 Select a PF number with the tuning control. PF numbers are listed on page 54.
- 4 Press the **MR** key.

This function is now assigned to the selected microphone key.

The following chart lists the tone frequencies assigned to the various display characters.

0	523.248Hz	C	5	880.000Hz	A
1	587.328Hz	D	6	987.770Hz	B
2	659.248Hz	E	7	1046.496Hz	C
3	698.464Hz	F	8	1174.656Hz	D
4	783.984Hz	G	9	1318.496Hz	E

- 5 Pressing the microphone "beep" key when a frequency is displayed will cause the radio to transmit a series of tones corresponding to the display frequency.

Automatic Power Off (APO)

This transceiver provides an Automatic Power Off function. If, after 59 minutes, no keys have been pressed or no signal has been received, a five second alert tone will sound. One minute after the alert, the transceiver will shut itself off.

When the APO shuts the transceiver OFF, it can be reactivated by simply turning the POWER switch back ON. The APO default is OFF.

Press the **F** key for longer than one second, and then press the **MHz** key. The APO indicator will appear.

The Automatic Power Off time can be selected. (The default is 60 minutes.)

You can change the automatic power-off time as follows.

- 1 Turn the **POWER** switch OFF.
- 2 Press and hold the **MUTE** key, and turn the **POWER** switch ON.
- 3 Select the OFF time (in minutes) with the **Tuning** control.
Select 60, 120, or 180 minutes.
- 4 To return to the normal frequency display, press any front panel key or wait 10 seconds.

Dimmer (DIM)

The display illumination intensity can be set to one of six levels. The range is d1 through d6, with d1 being the brightest and d2 being the default.

- 1 Press the **F** key, then press the **LOW/DIM** key. The intensity level will be displayed.

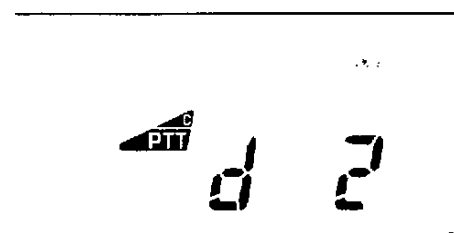

- 2 Select the intensity (d1 through d6) with the **Tuning** control or the **UP/DWN** keys.
- 3 To return to the normal frequency display, press any front panel key or wait 10 seconds.

The display intensity can be made to increase two steps brighter for five seconds when you press a key or adjust the **Tuning** control. No change occurs when d1 is selected.

- 1 Turn the **POWER** switch OFF.
- 2 Press and hold both the **VFO** and **LOW/DIM** key, and turn the **POWER** switch ON.

Beep Tone Level Adjustment

The beep can be set to one of eight levels. Each band can be individually set. The range is Off through b7 (maximum). The default is b5.

- 1 Press the **BAND SEL** key to select a band.

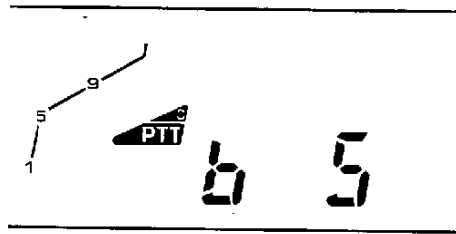

- 2 Press the **F** key for longer than one second, then press the **REV** key. The present level will be displayed.
- 3 Select the level with the **Tuning Control** or the **UP/DWN** keys. After 10 seconds, if no key has been pressed, the displayed level will be set and the previous frequency will be displayed.

Clearing Unused Bands from the Display

Unused bands can be cleared from the display. Transmit and receive is not possible if you turn the band display OFF.

- 1 Press the **F** key for longer than one second.
- 2 Press the **BAND SEL** key four times for the band to be cleared while the F indicator is flashing.

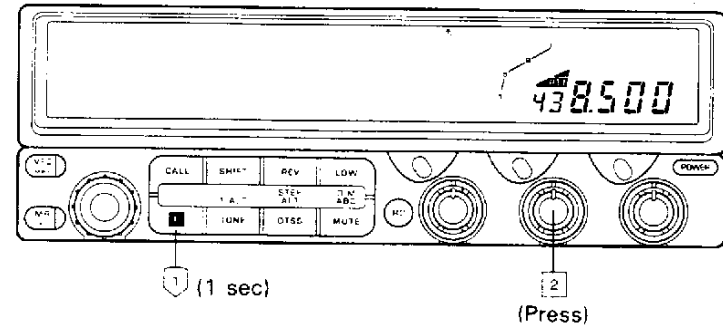

To re-display the band, repeat steps 1 and 2. The **BAND SEL** key only needs to be pressed once.

Note

- 1 - OFF - appears on the specified band display for 10 seconds, and that band is no longer displayed.
- 2 When the power switch is turned ON, the display will indicate -OFF- for 10 seconds, and then clear.

Key Locks

There are four different lock functions.

MICROPHONE KEY LOCK

Set the switch on the rear of the microphone to LOCK to disable all microphone keys except the PTT switch.

KEY LOCK FOR EACH BAND

Only the front panel POWER, F, PTT, F + MHz, and the microphone keys will operate.

- 1 Turn the **POWER** switch OFF.
- 2 Press the **C.SEL** key for the band to be key-locked, and press the **POWER** switch. The key-lock indicator for that band will light.

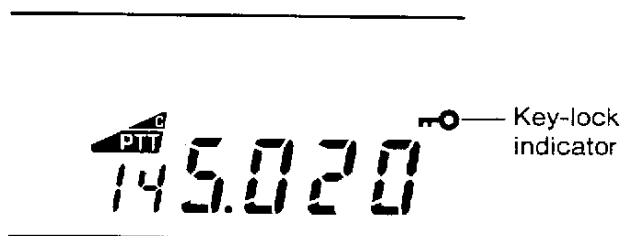

To cancel the function, repeat steps 1 and 2.

LOCK

Only the front panel POWER, F, PTT, F + MHz, and the microphone keys will operate.

Press the **F** key, then press the **MHz** key within 10 seconds.

The key-lock indicators for all bands will light.

To release the lock, press the **F** key, then press the **MHz** key within 10 seconds.

ALL LOCK

All operations, except the **POWER** switch, volume, and squelch, are disabled.

Switch the **POWER OFF** while the LOCK indicator is on, hold down the **MHz** key, and switch the **POWER ON** again,

The key-lock indicators for all bands will flash.

To release ALL LOCK, switch the **POWER OFF** while the LOCK indicator is on, press and hold the **MHz** key, and switch the **POWER ON** again. ALL LOCK cannot be canceled by VFO reset or MR reset.

Electronic tone for ALL LOCK

When the microphone PTT, CALL, VFO, MR, UP, DWN, or PF keys are pressed during ALL LOCK operation, the tone corresponding to each key sounds from the speaker.

Operation as a Repeater (U.S.A./Canada version)

CAUTION

This transceiver can be severely damaged by lightning strikes or electrostatic discharge, and may also be susceptible to inter-modulation distortion if operated on mountain top locations without benefit of ancillary protective equipment.

This is not a 100% duty cycle transmitter. Set the Time-Out Timer. Three minutes timeout is suggested to protect the transmitter.
(Please see page 32 for TOT set up.)

Note

- 1 Do not use the DTMF microphone for remote control while operating as a repeater.
- 2 Combinations of SHIFT and CTCSS can be used in the Repeater Cross-Band mode. DTSS and PAGE will not function in this mode.

This transceiver is capable of operating as a repeater.

You can select one of the following three functions.

● Cross-Band Repeat Mode

The transceiver listens on both bands simultaneously. As soon as a signal is received on one band, the other shifts from receive to transmit and re-transmits the incoming signal.

● Fixed Band Repeat Mode

This is a one way repeat operation. One band is dedicated to transmit and the other band is dedicated to receive.

● Dual band input repeater mode

(Only those models equipped with three bands)

If a signal is received on one of the two bands other than the transmit band, the transmit band re-transmits the signal.

Cross-Band Repeater operation

- 1 Select the operating frequencies and adjust the squelch controls.
- 2 Press the **BAND SEL** key of one band, and then press the **C.SEL** key to select the other band.
- 3 To turn the REPEATER CROSS-BAND function ON or OFF, press the **F** key for longer than one second and then press the **MUTE** key.

Three dots will appear on the frequency display for the selected bands.

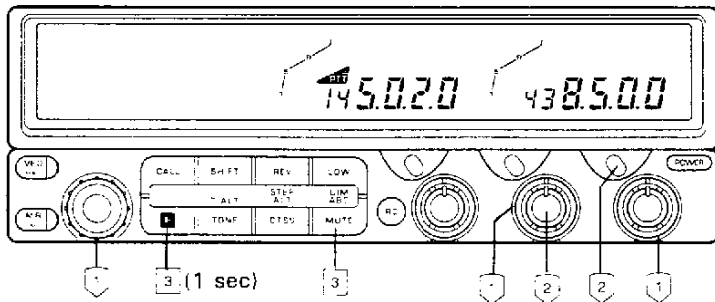

Fixed-band repeater operation

Use steps 1 through 3, but do not press the **C.SEL** key. The band dedicated to transmit is selected with the **BAND SEL** key.

Dual Input Repeater operation

Use steps 1 through 3, but do not press the **C.SEL** key. The band dedicated to transmit is selected with the **BAND SEL** key.

Hang Time Selection

The amount of time that the transceiver will remain keyed after the incoming signal has dropped is the Hang time. This prevents the repeater from returning to receive during momentary signal dropouts. The factory default is 500 milliseconds. The function can be switched ON or OFF.

Press and hold the **VFO** and **MUTE** keys, and turn the **POWER** switch ON.

REMOTE CONTROL

Pushbutton Control Using the DTMF Microphone

This transceiver can be controlled by the DTMF tones generated by the DTMF microphone. (The MC-45DM/DME microphone is optional in some market areas.)

Enabling this function

Press the **RC** key.
The remote control indicator will appear.

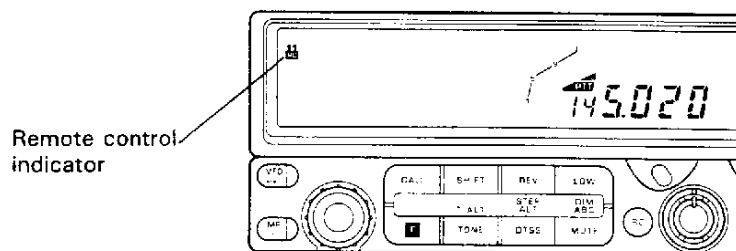

Operation

Connect the DTMF microphone.
The functions which can be controlled by the microphone are listed in the chart.
To cancel DTMF microphone control, press the **RC** key.

Controllable functions

Press the key	Function
1	Same as SHIFT on the transceiver
2	Same as TONE on the transceiver
3	Same as REV on the transceiver
4	Same as MHz on the transceiver
5	Monitor key
6	Indicate frequency by tone.
7	VOL UP/DWN ON or OFF
8	—
9	SQL UP/DWN ON or OFF
0	Same as LOW on the transceiver
A	Enter key
B	Same as C.SEL on the transceiver
C	Same as MUTE on the transceiver
D	Same as F on the transceiver
*	DOWN key
#	UP key



REMOTE CONTROL

Press D key (F key), then one of these keys	Function
1	Tone alert sound selection
2	Tone frequency selection
3	Tone alert function ON or OFF
4	—
5	DTMF key lock setting
6	DTMF key lock cancel
7	—
8	—
9	—
0	Change the display illumination intensity
A	—
B	—
C	To turn Repeater ON or OFF
D	F key operation OFF
*	DOWN key
#	UP key

Reference

Microphone key positions and functions

The functions not in **bold** are secondary, and are operated by pressing the **D** key, then the secondary function key.

1 SHIFT B.SEL	2 TONE T.SEL	3 REV T.ALT	A ENT
4 MHz	5 MONI L. ON	6 F.BEEP L. OFF	B C.SEL
7 VOL	8	9 SQL	C MUTE REP.
* DWN DWN	0 LOW DIM	# UP UP	D F F OFF

Note

- 1 The DTSS, PAGE, and DTMF memory features do not function while the MC-45DM or MC-45DME microphone is being used for remote control of this transceiver.*
- 2 If DTMF audio from other equipment is picked up by your microphone while you are using remote control, a function corresponding to the interfering DTMF audio may be initiated.*

DISPLAY DEMONSTRATION MODE

Function selection

Initiating the display demonstration mode causes the following sequence to begin :

- 1 The normal display appears after power is switched on.
- 2 All display segments light and flash three times 15 seconds after power on.
- 3 A series of 5 different messages begin to appear as the display segments go out. The first 4 messages are not programmable. The fifth message is programmable. Random segments are displayed until you program Message 5 for the first time.

This cycle repeats until the demonstration mode is deactivated. The transceiver can be used in this mode, if desired. If there is no key entry for more than 10 seconds, the transceiver reverts back to the demonstration mode.

- 1 Turn the power off.
- 2 Turn the power on while holding down the **CALL** key.

Repeat the same procedure to deactivate the function.

Programming Characters

- 1 Turn the power off while in the demonstration mode.
- 2 Turn the power on while holding down both the **VFO** and **TONE** keys. Random segments (or the previously programmed characters) appear. The 1 GHz digit blinks while in this state. Operate the **CALL** key to specify if you wish this digit on or off.
- 3 Input your desired message by using the keys indicated in the drawing to turn display segments on or off. The number "8", for example, is programmed by turning on 7 segments.

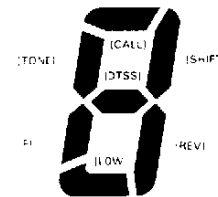

- 4 Press the **MUTE** key to advance to the next digit.
- 5 Repeats steps 3 and 4 to program the complete string of characters or numbers.
- 6 Press the tuning control to exit the character program mode and return to the demonstration mode.

CLOCK

This transceiver can display the time in one of three ways. The operations differ according to the functions as follows:

Display the clock on a band not currently used:

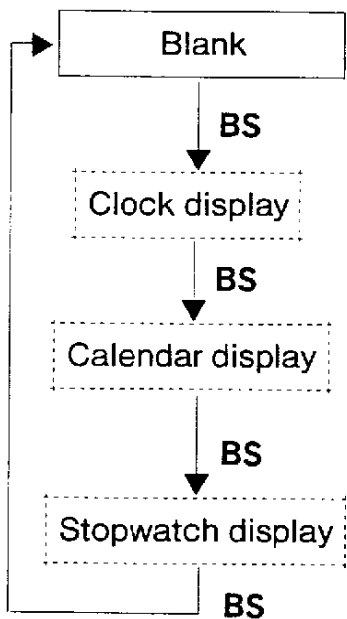

Display the clock when the transceiver is ON:

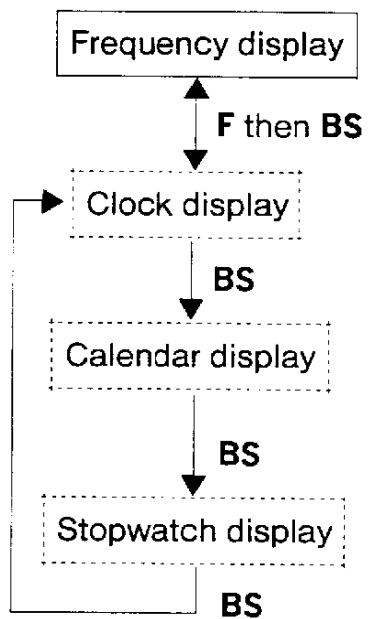

BS: BAND SEL key

Display the clock when the transceiver is OFF:

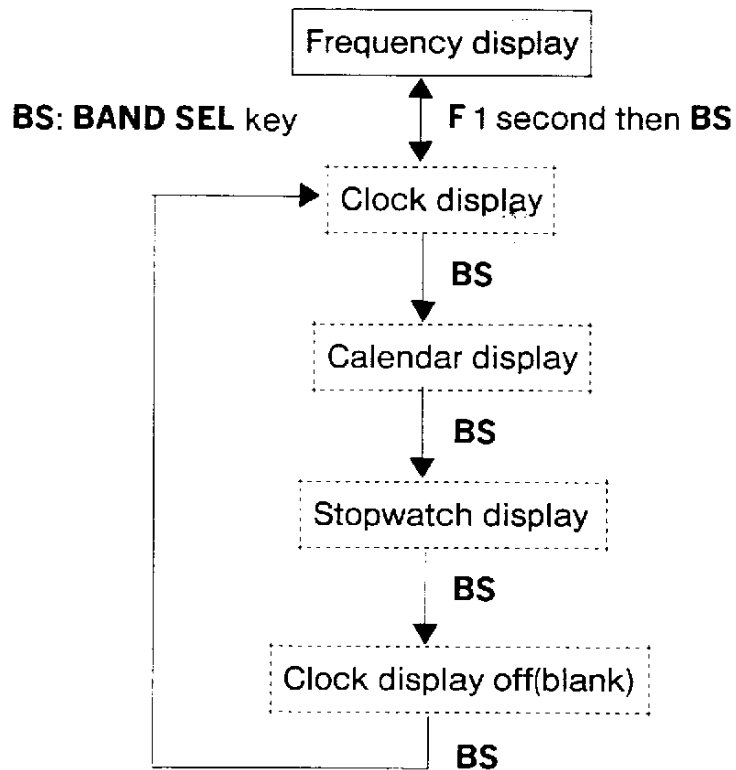

CLOCK

Note
 Clock error will not exceed one minute per month at ambient temperatures under 25 degrees.

Setting Time and Date

- 1 To select the clock set mode, press the **F** and **TONE** keys, and turn ON the **POWER**. All settings are entered in sequence.



- 2 Set the HOUR
Rotate the **Tuning** control (0~23), then press the **TONE** key.
- 3 Set the MINUTES
Rotate the **Tuning** control (0~59), then press the **TONE** key.
Seconds are also reset, and the count restarts from zero seconds.
- 4 Set the YEAR
Rotate the **Tuning** control (00~99), then press the **TONE** key.
- 5 Set the MONTH
Rotate the **Tuning** control (1~12), then press the **TONE** key.
- 6 Set the DAY
Rotate the **Tuning** control (1~31), then press the **TONE** key.

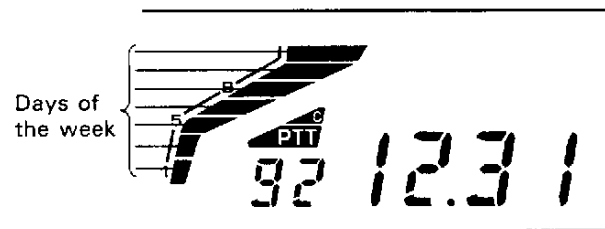

- 7 Set a day of the week
(See the Level Meter illustration.)
The segments of the level meter are used to indicate the day of the week.

Rotate the **Tuning** control to set the day of the week, then press the **TONE** key.

The transceiver will return to previous mode.

Time check

To set the clock against an accurate time standard, such as WWV, CHU, or a local broadcast station (time check), have the clock displayed. Press the **C.SEL** key for the band displaying the clock when the hour is announced.

The seconds are reset to zero, and the time count restarts.

Note

If the seconds count is between 30 to 59 when **C.SEL** is pressed, the minute digit will increment.

Calendar display

Select this function (as shown on page 65).

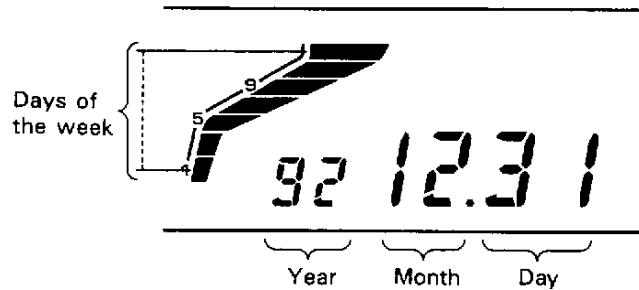

STOPWATCH

Select this function (as shown on page 65).

Press the **C.SEL** key to START or STOP the stopwatch.

Press the **C.SEL** key for longer than one second to RESET the stopwatch to zero.

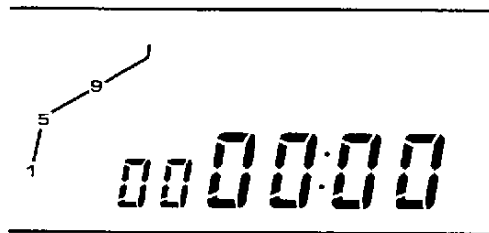

Other Clock Functions

This transceiver has these additional clock functions:

- **ALARM**

Sounds at the preset time every day.

- **TIME ON SWITCH**

Switches the transceiver ON at a preset time every day.

- **TIME OFF SWITCH**

Switches the transceiver OFF at a preset time every day.



CLOCK

Function selection

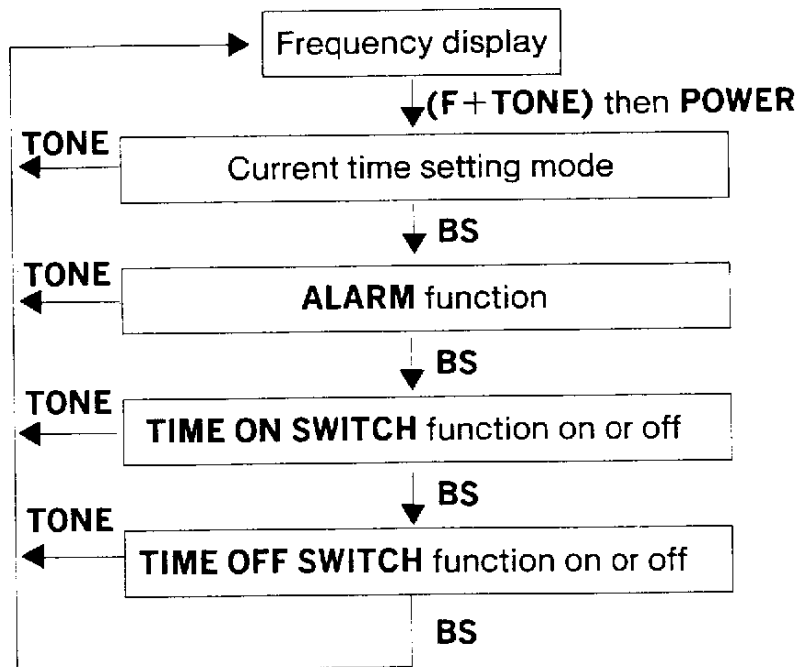

BS: BAND SEL key

ALARM

- 1 Press and hold both the **F** and **TONE** keys, then turn the **POWER** switch ON.
- 2 In the time set mode, press the **BAND SEL** key. The (HOURS) indicator will flash. If the alarm was set previously, the alarm time set earlier appears.
- 3 Rotate the **Tuning** control (0~23) to set the HOUR, then press the **TONE** key.
- 4 Rotate the **Tuning** control (0~59) to set the MINUTES, then press the **TONE** key.
- 5 Rotate the **Tuning** control to display the alarm indicator.

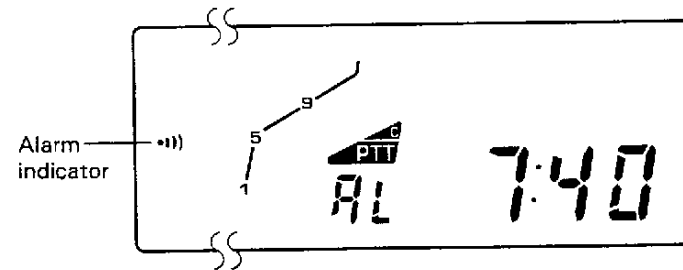

- 6 Press the **TONE** key to set the Alarm. The normal frequency display reappears automatically.

TIME ON SWITCH

Time-ON programming:

- 1 In the clock set mode, press the **BAND SEL** key twice. The (HOURS) indicator will flash.
- 2 Rotate the **Tuning** control (0~23) to set the HOUR, then press the **TONE** key.
- 3 Rotate the **Tuning** control (0~59) to set the MINUTES, then press the **TONE** key.
- 4 Rotate the **Tuning** control to display the ON indicator.

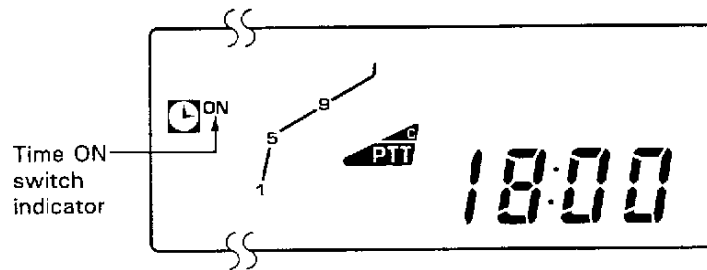

- 5 Press the **TONE** key to set the TIME ON SWITCH.
The normal frequency display reappears automatically.

TIME OFF SWITCH

Time-OFF programming:

- 1 In the clock set mode, press the **BAND SEL** key three times to select the TIME OFF SWITCH mode. The (HOURS) indicator will flash.
- 2 Rotate the **Tuning** control (0~23) to set the HOUR, then press the **TONE** key.
- 3 Rotate the **Tuning** control (0~59) to set the MINUTES, then press the **TONE** key.
- 4 Rotate the **Tuning** control to display the OFF indicator.

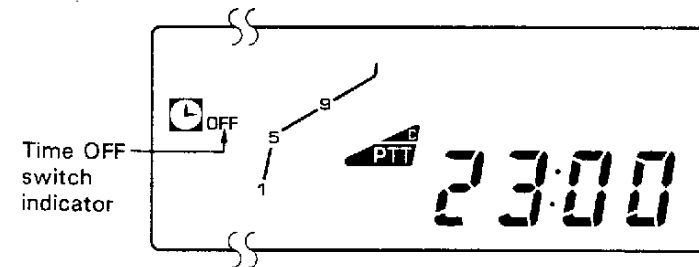

- 5 Press the **TONE** key to set the TIME OFF SWITCH.
The normal frequency display reappears automatically.

CTCSS OPERATION

This function operates only when the optional TSU-7 is installed.
The CTCSS unit (TSU-7) installation instructions are shown on page 88.

When the Continuous Tone Code Squelch System (CTCSS) is ON, the transceiver will not receive (decode, or open squelch) unless the selected encode tone is received. You cannot use the CTCSS function during repeater operation since repeaters intercept and remove the CTCSS tone frequency.

Tone Frequency Selection

All parties must use the same tone frequency to successfully communicate. The decode tone frequency for each band is independently selectable.

- 1 Press the **F** key for longer than one second. The F indicator will flash.
- 2 Press the **TONE** key. The current decode tone frequency displays.

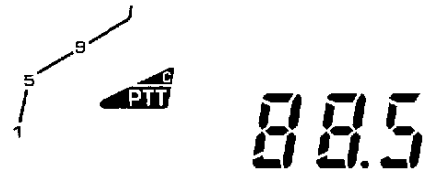

- 3 Rotate the **Tuning** control or press the microphone **UP/DWN** key to select a decode tone frequency.

- 4 After the tone frequency is selected, the previous mode is resumed 10 seconds after any front panel key is pressed.

There are 38 possible decode tone frequencies. The factory default is 88.5 Hz.

No.	(Hz)	No.	(Hz)	No.	(Hz)	No.	(Hz)
01	67.0	06	82.5	11	97.4	16	114.8
02	71.9	07	85.4	12	100.0	17	118.8
03	74.4	08	88.5	13	103.5	18	123.0
04	77.0	09	91.5	14	107.2	19	127.3
05	79.7	10	94.8	15	110.9	20	131.8

No.	(Hz)	No.	(Hz)	No.	(Hz)	No.	(Hz)
21	136.5	26	162.2	31	192.8	36	233.6
22	141.3	27	167.9	32	203.5	37	241.8
23	146.2	28	173.8	33	210.7	38	250.3
24	151.4	29	179.9	34	218.1		
25	156.7	30	186.2	35	225.7		

CTCSS Set Up

- 1 Select the band with the **BAND SEL** key.
- 2 Press the **TONE** key until the CTCSS indicator displays. The indicator will alternate between T (for transmit encode tone) to CTCSS (for transmit and receive tone squelch.)

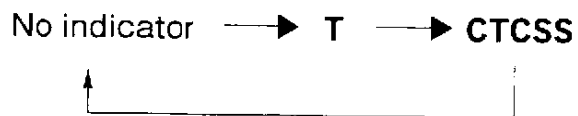

When there is no indicator displayed, the transceiver is in the carrier squelch mode, and will not make use of either tone squelch feature.

Transmission

When the **PTT** switch is pressed, the selected encode tone frequency is sent along with the normal voice audio.

Receive

The squelch opens only when the incoming encode tone frequency matches the preset CTCSS decode tone frequency.

For more reliable operation, adjust and use the noise squelch along with the CTCSS.

Receive tone frequency display

You can confirm the tone frequency you receive.

- 1 Press and hold the **TONE** key for longer than 1 second.

A tone frequency replaces the operating frequency in the display, and the 10 kHz decimal blinks.

When the transceiver receives a signal, it performs scanning to identify the receive tone frequency. The transceiver stops scanning when it identifies the tone frequency. You will recognize this because a beep sounds and the displayed tone frequency blinks.

To release this function, press the **TONE** key again.

Note

- 1 After the transceiver has identified the tone frequency and stopped scanning, it does not resume scanning even if it receives another signal. To perform scanning again, release this function once by pressing the **TONE** key, and then repeat step 1.
- 2 When you release this function after scanning has been completed, the tone frequency for CTCSS will be automatically replaced by the identified tone frequency.
- 3 CTCSS does not function on other bands while the transceiver is scanning a received signal to identify its tone frequency.

DTSS OPERATION (Dual Tone Squelch System)

Preparation for DTSS Operation

This function allows the squelch to be opened upon reception of a three-digit code matching the DTSS code selected in your transceiver. Once the squelch is opened, the transceiver operates normally. If no signal is received for longer than two seconds, the squelch is again closed and the transceiver waits until the matching code is again received.

This function is not available in some areas.

Note

Occasionally, DTSS may not open the squelch of your called party. This situation may occur in the following cases:

1. When DTSS is used on several bands at the same time.
2. When a repeater ID and DTSS code are identical.

If this occurs, hold down the PTT switch and press the DTSS key to resend the code.

Note

The DTSS and PAGE features do not function while the MC-45DM or MC-45DME microphone is being used for remote control of this transceiver.

DTSS Code Selection

DTSS codes from 000 through 999 can be selected from the VFO mode. The codes can be stored in both memory channels and the Call Channel. The initial setting of the DTSS code is 000.

- 1 Select the Band using the **BAND SEL** key.
- 2 Select the **VFO** mode with the **VFO** key.
- 3 Press the **DTSS** key. The display will shift as shown in the diagram. Continue pressing the **DTSS** key until the DTSS indicator appears in the display.

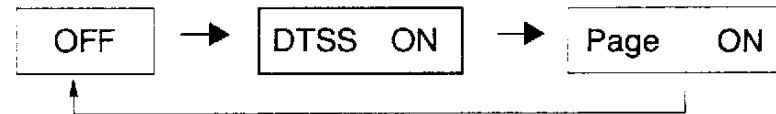

- 4 Press the **F** key for longer than one second, then press the **DTSS** key. The display will change to the DTSS code entry mode. The digit just to the right of the "C" will be flashing.

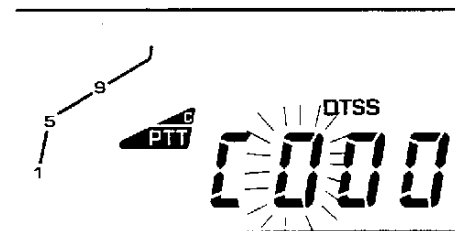

- 5 Select any digit from 0 through 9 using the **Tuning** control, or by pressing the **UP/DWN** keys, and then press the **DTSS** key.

Or press the desired number on the microphone keypad. This will enter the number and advance the transceiver to the next number position without again pressing the DTSS key.

- 6 After selecting the first digit, a "beep" will sound and the middle digit will flash. Select the next number by using either method previously described.

- 7 Select the final digit. After the last digit is entered, the display will return to the normal frequency mode indicating the process has been successfully completed.

Note

- 1 *If a key other than the DTSS key is pressed during the code selection, the code selection mode is canceled.*
- 2 *If no action is taken for longer than 10 seconds during the code selection process, the mode is automatically canceled.*
- 3 *If DTMF audio from other equipment is picked up by your microphone while you are entering DTMF digits, digits corresponding to the interfering DTMF audio may be entered instead of the digits entered on your keypad.*

Using the DTSS function

Set the DTSS code to match the stations you will contact.

Press the **DTSS** key once or twice until the DTSS indicator appears in the display. The squelch will now remain closed until the correct code group is received.

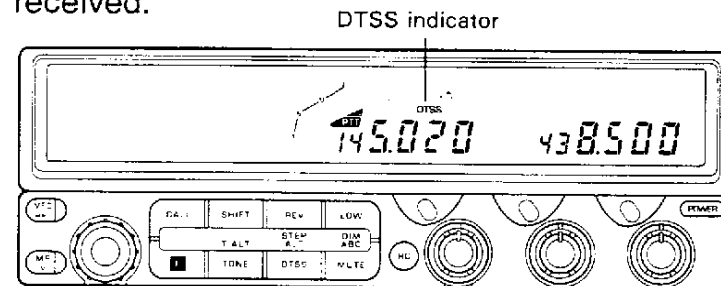

Transmit operation

When the PTT switch is pressed, the selected code group will be transmitted. It will take approximately one half second to transmit the three tones. To transmit the DTSS signals again, press the DTSS key while holding down the PTT switch. Microphone audio will be muted while the tones are being sent.

Receive operation

Rotating the squelch control counterclockwise with DTSS on results in no sound from the speaker. However, when a signal having the matching programmed code is received, the squelch will open. If no signal is received for two seconds or more, the squelch closes.

It is recommended you press the DTSS key to turn the DTSS function off after communication starts. When the DTSS function is off, a DTSS code is not transmitted each time you press the PTT button, so you can communicate without interruption.

To cancel the DTSS function, press the DTSS key twice.

Setting Delay Time

The DTSS signal is not sent immediately after pressing the PTT switch. A delay has been provided to allow the DTSS signal to be passed by repeaters with slow response times.

The delay time is fixed at 250 ms for channels other than shift and split channels and it cannot be changed. For shift and split channels, the delay time is initialized to 350 ms, but it can be changed to 550 ms.

The delay is the same for all bands.

To select the delay time

- 1 Press and hold the **F** key, then press the **DTSS** key. The display will indicate the current delay (250ms is not displayed).

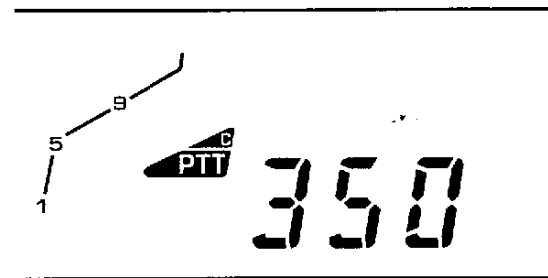

- 2 Rotate the **Tuning** control or press the microphone **UP/DWN** keys to select the delay time.
- 3 To return to the normal frequency display, wait 10 seconds for automatic return, or press any key.

Note

Even if the delay time is set to 550 ms, it may not be possible to use the DTSS function for some repeaters if the repeater ID and the DTSS code are the same. In this case, hold down the PTT button and press the DTSS key again to send the DTSS code.

Intercom using DTSS Codes

The intercom function allows two way simultaneous (full duplex) communication with the convenience of a ring tone when receiving a call.

- 1 Select a receive frequency that matches the transmit frequency of the other station.
- 2 Press the **DTSS** key to activate DTSS on the receive frequency. The other station must be able to send a DTSS-coded signal.
- 3 Select a transmit frequency on a different band that matches the receive frequency of the other station. This will allow full duplex communication. Do not activate DTSS on your transmit frequency.
- 4 Press the **F** key, and then press the **RC** key. The handset, TOT, and key-lock indicators appear.

Release the intercom function by pressing the **F** key, and then the **RC** key.

Note

The time-out timer is set automatically to 3 minutes.

Control by External DTMF Signal

This transceiver can be controlled by any other transceiver which can transmit DTSS and DTMF signals.

Function selection

- 1 Select a common band for the transceiver and the control transceiver, and set the same frequency on both transceivers. Set a DTSS code on the transceiver.
See DTSS code selection on page 72.
- 2 Press the **BAND SEL** key to select the band to be controlled. DTSS should be turned off on this band.
- 3 Press the **F** key for longer than 1 second, then press the **RC** key on the transceiver.

Note

The DTSS code is used as a secret number for remote operation, not for the DTSS function. So, if the remote transceiver can send DTMF signals, it can perform this operation even if it does not have the DTSS function.

Operation

- 1 Set the frequency for the remote transceiver that will transmit the DTSS and DTMF signal. Cancel the DTSS mode on the remote transceiver.
- 2 The remote transceiver should be placed in transmit, and the operator should send "A", followed by the correct DTSS code, then "#".

3 The transceiver is now ready to accept the external DTMF Remote Control signal.

The following functions can be controlled by the remote station.

DTMF key	Control function
1	Enables the T.ALT function.
2	Enables the tone.
3	Enables the tone squelch.
4	Disables the T.ALT function.
5	Disables the Tone.
6	Disables the tone squelch.
7	Call channel
8	VFO mode
9	Memory channel
0	Switches transmit output power.

DTMF key	Control function
A	The frequency entry mode is selected, and the frequency can be entered with the numeric keys 0 through 9.
B	Tone frequency selection mode
C	Turns the Repeater mode ON.
D	Turns the Repeater mode OFF.
*	Same as DOWN key
#	Same as Up key
A then B	Intercom function set
A then D	Change between the operation band and the transmit band.
A then 0~9	ENTER
A then #	Terminates the remote control function.

4 The remote operator must terminate the Remote Control function by sending "A""#".

To re-establish Remote Control, repeat step 2.

To cancel the function, press the **F** key for longer than 1 second, then press the **RC** key.

Reference

DTMF key positions and functions that can be controlled.

1 T.ALT ON	2 TONE ON	3 CTCSS ON	A ENT
4 T.ALT OFF	5 TONE OFF	6 CTCSS OFF	B TONE SEL
7 CALL	8 VFO	9 MR	C REP. ON
* DWN	0 LOW	# UP	D REP. OFF

Note

- 1 To set the memory channel and tone frequency, select each mode, then input the channel number with the numeric keys. (For the channel numbers of tone frequencies, please refer to page 70.)
- 2 It is not legal to transmit control codes on the 144 MHz band. Transmit control codes only at 222 MHz or higher on the 220 Mhz band, or on the 440 MHz band. (U.S.A. version only)

PAGE

Page Code Memories

Page is useful for net operations or for selectively calling an individual station.

Before using Page, make prior arrangements with all members of the group or net, so that all involved parties know which DTMF code will be assigned for individual calls and for group calls, and that everyone knows their individual code. Page uses a three digit code (000 through 999). Even a very large group will have code groups to spare.

Page permits the calling station's three digit code to be displayed by the receiving transceiver to allow instant identification of the calling station.

Ten different Page Code Memories are available.

Page Code Memory No.	Usage
A	Stores your own Page code.
0	Automatically stores the calling station's code during receive. Can also temporarily store the code for the station to be called.
1~8	Stores group codes, and the codes of other stations.

PAGE

Note

- 1 The DTSS and PAGE features do not function while the MC-45DM or MC-45DME microphone is being used for remote control of this transceiver.
- 2 If DTMF audio from other equipment is picked up by your microphone while you are entering a Page code, digits corresponding to the interfering DTMF audio may be entered for the code instead of the digits entered on your keypad.

Code Selection

First, program your Individual Code into Memory PA for each band.

- 1 Press the **BAND SEL** key to select the band.
- 2 Press the **DTSS** key until the Page indicator appears. Please refer to the example.

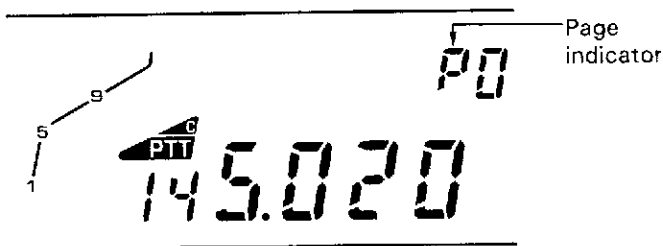
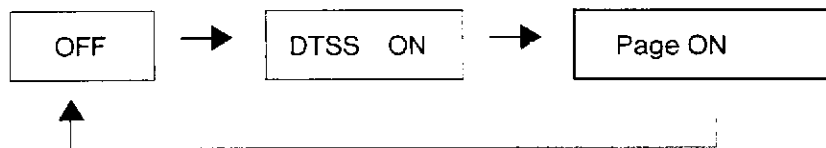

- 3 Press the **F** key for longer than one second. A beep will sound and the F indicator will flash. While the F indicator is flashing press the **DTSS** key. The display will change to the Page Code Memory Channel Selection mode and the Page Code Memory Channel indicator will flash.

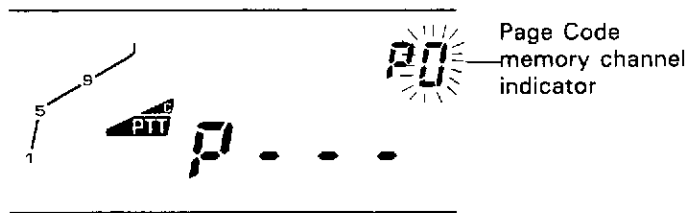

- 4 Select PA (your Individual Code) with the **Tuning** control.

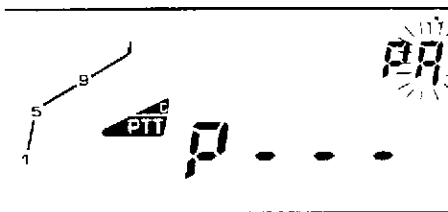

- 5 Press the **DTSS** key to finish Page Code Memory Channel Selection, and enter the Page Code Selection mode. The first digit to the right of the large "P" will flash.



- 6 Use the **Tuning** control, the microphone **UP/DWN** keys, or press the appropriate key on the microphone keypad to select the first Page Code digit.

- 7 Press the **DTSS** key to enter the number into memory. The middle digit will then flash.
- 8 Repeat steps 6 and 7 to finish programming this particular page code. After the final digit is entered, the display will return to the Page Channel Selection mode.

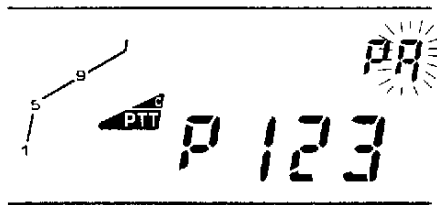

This completes programming your code. Before Page can be used, you must also program the transceiver for the codes to be called.

- 9 Select the other station's code (P1 through P8) with the **Tuning** control, then press the **DTSS** key.
- 10 Select the next Page Code you wish to program as previously described in steps 6 through 9.
Page is now available.
- 11 By pressing any key except the **DTSS**, **MR** or microphone **UP/DWN** keys, Page Code Select mode is canceled, and the Page mode is available.
You can Page the last selected station code.

If the station to be Paged is different from the last selected code, perform step 3, select the correct page code memory channel with the **Tuning** control, then press the **PTT** switch.

Note that the microphone DTMF pad can be used to set the Page channels and codes in place of the **Tuning** control. To cancel the Page mode, press the **DTSS** key.

Code Transmission

Select the operating frequency.

Press the **PTT** switch. The selected Page code will be sent, along with your Page code (the one stored in PA).

Note
If the Paged transceiver is in the battery save mode, the code may not be received or successfully decoded. To be sure the code is received, transmit it for several seconds, release the **PTT** switch, and transmit again.

Page Code Monitoring

Press the **DTSS** key repeatedly until a Page channel digit appears on the display. When your Page code is received, your squelch will open and you will hear an alert tone sequence. The display will indicate the individual or group code of the calling station.

Standby with individual code

If the calling station transmits your individual code, Page Mode Memory Channel 0 will display, along with the Page code of the calling station. (Example: calling station Page code is 444.)

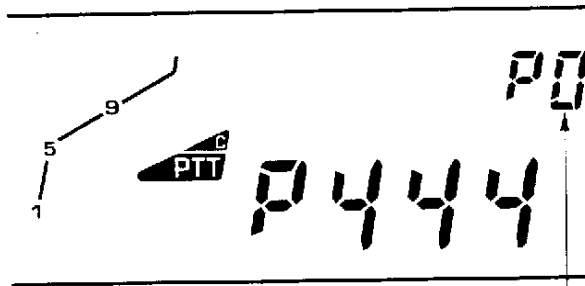

Zero is displayed to indicate your station is being called.

Standby with a group code

If the calling station transmits the group Page code, the group code and the Page Mode Memory Channel Number that contains that code will display.

(Example : group Page code 789 is stored in Page Mode Memory Channel 5.)

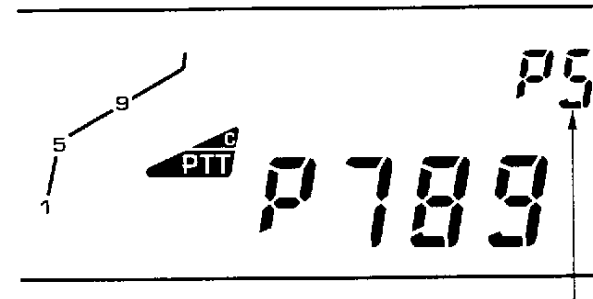

This Page Mode Memory Channel Number is 1 to 8 inclusive to indicate a group call has been received.

Err will appear on the display if there is a problem in code identification.

For increased efficiency, leave the Page mode after the initial calls have been made, to prevent transmitting Page Code data at each transmission.

Code Lockout

Codes are locked out only in receive in the Page Mode.

It is possible to temporarily disable Page Code Memories one through eight during receive. This will allow you to control which individuals or groups can open your squelch. Page Code Memories 0 and A cannot be locked out. Locking out a particular code for receive will not prevent the code from being transmitted, if you select that particular Code Memory.

- 1 Press the **DTSS** key repeatedly until a Page channel digit appears on the display.
- 2 Press the **F** key for longer than one second, then press the **DTSS** key.
- 3 Select the Page Code Memory Channel number you wish to lock out by using the **Tuning** control or the microphone **UP/DWN** keys.
- 4 Press the **MR** key. A ★ will appear to the left of the Page Code Memory Channel indicator to remind you that you have locked out this code memory from receive.

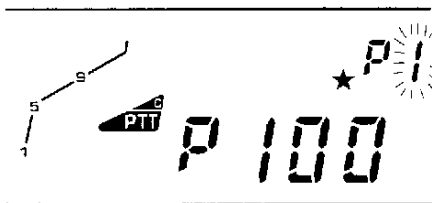

To restore the code memory for receive, repeat steps 2 through 4.

Answer-Back (U.S.A./Canada version)

Answer-back (or transpond) enables your transceiver to automatically transmit your Page code back to the station paging you to acknowledge receipt of their signal by your transceiver.

Set Up

Press and hold the **F** key, then press the **CALL** key.

To cancel answer-back, repeat the last step. This function automatically cancels once a Page is received.

Automatic Page Cancel

(U.S.A./Canada version)

It is suggested that the Page mode be canceled after initial contact is established, and a conversation begins. This transceiver can do this automatically, once a Page has been received and you begin transmitting.

Set Up

Press and hold the **F** key, and then press the **SHIFT** key. To cancel this function, repeat the last step while in the Page mode.

TONE ALERT SYSTEM

Tone Alert provides an audible alarm when someone transmits on the frequency which you are monitoring.

When Tone Alert is used together with CTCSS, Page, or DTSS, that function becomes more effective, since you can wait for a call from a specific station.

When Tone Alert is ON, voice communications will not be heard. Only the Alert tone will sound.

Note

If the CTCSS, DTSS or Page functions are used in conjunction with Tone Alert, the Tone Alert sounds only when the same tone or code is received.

Set Up

- 1 Press the **BAND SEL** key to select the band.
- 2 Select one of the CTCSS, DTSS, or Page modes, if so desired.
- 3 Press the **F** key, then the **T.ALT** key.

The Tone Alert indicator will appear .

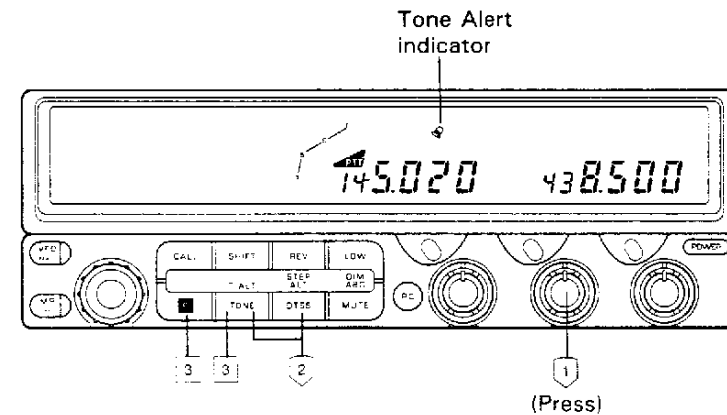

When a signal is present:

The Tone Alert indicator flashes, and the transceiver "beeps" for approximately five seconds when a signal is present.

The time when the signal was received will be displayed. The time will change each time a new signal is received.



Press the **PTT** switch to cancel the Tone Alert function.

To return to the normal frequency display when no signal is received (when the Tone Alert indicator does not flash and the time is not displayed), perform step 3.

Note

You can **MONITOR** the transmission with the microphone **PF** key while the Tone Alert function is **ON**.
(See page 54)

Alarm Sound Selection

This transceiver provides three different alarm sounds.

- 1 Press the **BAND SEL** key to select the Alert tone.
- 2 Turn the **POWER** switch OFF.
- 3 Press and hold the **F** key and the **SHIFT** key, and turn the **POWER** switch ON.

The current Alert sound indicator will appear.

Alert Sound	Indicator
Ring tone	bEL1
High tone	bEL2
Melody	bEL3

- 4 Use the **Tuning** control to select the desired Alert sound.
- 5 Press any key to return to the previous state.

MAINTENANCE

General Information

Your transceiver has been factory aligned and tested to specification before shipment. Under normal circumstances the transceiver will operate in accordance with these operating instructions. The adjustable trimmers and coils in your transceiver have been adjusted at the factory and should only be readjusted by a qualified technician with proper test equipment. Attempting service or alignment without factory authorization can degrade performance, and void the transceiver's warranty.

When operated properly, the transceiver will provide many years of service without requiring realignment or adjustment. The information contained in this section gives some general operational problems, and their solutions, which can be resolved without need of test equipment.

Service

If it ever becomes necessary to return this equipment to your dealer or service center for repair, pack it in its original box and packing, and include a complete description of the problems involved. Also include your telephone number. You need not return an accessory item unless it is directly related to the service problem.

Service Note

*Dear Friend,
If you wish to correspond on a technical or operational question, please make your note short, complete, and to the point, and PLEASE make it readable.*

*Please list: The model and serial number.
 The problem you are having.*

Provide sufficient detail for a customer relations specialist, or a service technician, to attempt diagnosis. Information such as other equipment in the station, meter readings and anything else you feel might be useful in attempting diagnosis should be included in your correspondence. Please send correspondence to our current address, which may be found in the latest issue of all major Amateur Radio magazines. Mail to the U.S. office should be sent to the Post Office Box address.

Caution

Do not pack the equipment in crushed newspapers for shipment. Extensive damage may result during shipment. Use the original box and packing fixtures, or their equivalent.

NOTES:

- 1 Record the date of purchase, model, serial number and dealer from whom purchased.*
- 2 For your own reference, retain a written record of any service or maintenance performed on the unit.*
- 3 If claiming warranty service, a photocopy of the bill of sale, or other proof of purchase, must accompany the transceiver when it is presented for service.*

In Case Of Difficulty

The problems described in this table are commonly encountered operational malfunctions. These types of difficulties are usually caused by improper hook-up, accidental incorrect control settings, or operator error due to incomplete programming, and are not caused by a circuit failure. Please review this table, and the appropriate section(s) of this Instruction Manual, before assuming your transceiver is defective.

<i>Symptom</i>	<i>Probable cause</i>	<i>Corrective action</i>
Indicators do not light and no receiver noise is heard when POWER is switched ON.	<ol style="list-style-type: none"> 1. Bad power cable or connections. 2. Blown power supply fuse. 	<ol style="list-style-type: none"> 1. Check cables and connections. 2. Check for the cause of the blown fuse and replace the fuse.
No sound from the speaker. No signal can be received.	<ol style="list-style-type: none"> 1. Squelch is closed. 2. With the TSU-7 installed: CTCSS is ON. 3. DTSS or Page function is ON. 	<ol style="list-style-type: none"> 1. Reduce the SQL control setting. 2. Press the TONE/T.ALT key to turn off the CTCSS. 3. Press the DTSS key to turn off the function.
No transmitter output.	<ol style="list-style-type: none"> 1. Microphone plug not seated. 2. Poor antenna connection. 	<ol style="list-style-type: none"> 1. Plug into jack until "click" is heard. 2. Connect antenna securely.
Weak signals cannot be received.	Poor antenna connection.	Connect antenna securely.
Display is dark.	<ol style="list-style-type: none"> 1. Supply voltage is low. 2. DIM set too dark. 	<ol style="list-style-type: none"> 1. Check that voltage is 13.8 V DC $\pm 15\%$. 2. Press the F key and the LOW/DIM key. (See page 56)
No memory back up.	Backup battery voltage is low.	See Microprocessor memory backup page 34.
The display does not change when the tuning control is rotated.	<ol style="list-style-type: none"> 1. The LOCK function is ON. 2. The ALL LOCK function is ON. 	<ol style="list-style-type: none"> 1. Press the F key, then press the Tuning control within 10 seconds. 2. Hold the Tuning control, switch the POWER ON.
When activating the intercom, the RC indicator blinks, the key-lock indicators appear, and neither the keys nor controls can be operated.	The F key was held down for longer than one second, then the RC key was pressed.	Repeat the same key strokes. (F (1 s) then RC)

<i>Symptom</i>	<i>Probable cause</i>	<i>Corrective action</i>
Pressing the F key then the RC key does not activate the intercom function.	DTSS is activated on your transmit frequency.	Press the DTSS key twice to disable DTSS on your transmit frequency.
DTSS or Page does not work through the repeater.	The repeater ID interrupts the data string, so the remote station cannot receive the code properly.	Release the PTT, confirm that no ID is transmitted. Then press the DTSS key while holding down the PTT.
DTSS or Page does not work.	The remote transceiver is in the battery save mode.	Press PTT again.
The S meter indicates mid-scale, and only strong signals can be received.	S-Meter squelch is set.	Cancel S-Meter squelch. (See page 28)
The received signal breaks up.	The SQL control has been set too tight.	Select a frequency with no signal, and set the control so the noise just stops.
Transmitter "beeps" and returns to receive.	The Time-Out Timer is ON.	Turn the time-out timer off. (See page 32.)

Some dial frequency relationships may result in internal heterodyne tones being generated by the TM-942A, TM-742A/742E, or TM-642A. This is not a defect. The following formulas may be used to determine if a tone will be present with a particular frequency relationship.

If any of the following equations are true, a tone may be generated that is strong enough for you to hear it in the speaker of both bands. These tones can be generated only when more than one band is on at a time:

For TM-942A or TM-742A/742E with the optional FM unit UT-1200:

$$\begin{aligned} & ((1.2\text{GHz operating frequency}) - 59.7\text{MHz}) \times 2 - ((70\text{cm operating frequency}) + 21.6\text{MHz}) \times 5 = 59.7 \text{ MHz} \\ & \text{or } ((70\text{cm operating frequency}) + 21.6\text{MHz}) \times 4 - (((1.2\text{GHz operating frequency}) - 59.7\text{MHz}) / 2) \times 3 = 59.7 \text{ MHz} \\ & \text{or } ((1.2\text{GHz operating frequency}) - 59.7\text{MHz}) \times 2 - ((70\text{cm operating frequency}) + 21.6\text{MHz}) \times 5 = 21.6 \text{ MHz} \end{aligned}$$

For TM-742A with the optional FM unit UT-220S or TM-642A with the optional FM unit UT-440S:

$$((220\text{MHz operating frequency}) - 30.825\text{MHz}) \times 5 - ((70\text{cm operating frequency}) + 21.6\text{MHz}) \times 2 = 30.825 \text{ MHz}$$

For TM-742A/742E with the optional FM unit UT-50S:

$$((6\text{m operating frequency}) + 10.595\text{MHz}) \times 7 - ((70\text{cm operating frequency}) + 21.6\text{MHz}) = 21.6 \text{ MHz}$$

In rare cases, certain routings of cables, such as the Front Panel separation or external speaker cable, may result in an internal heterodyne being generated even with different frequency relationships than those listed above. Again, this is not a defect.

Simply re-position the cables responsible for causing the heterodyne.

OPTIONAL ACCESSORIES

CTCSS UNIT

TSU-7

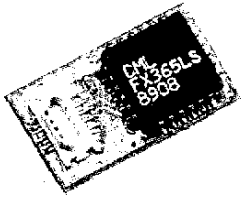

DETACHABLE FRONT
PANEL KIT(3m)

(See page 91)

DFK-3

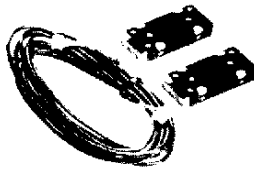

DETACHABLE FRONT
PANEL KIT(4m)

(See page 89)

DFK-4

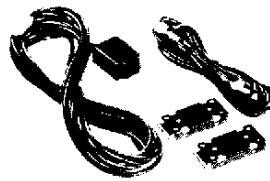

DETACHABLE FRONT
PANEL KIT (7m)

(See page 89)

DFK-7



MULTI-FUNCTION
MICROPHONE
(E: Europe version)

MC-45/45E



MULTI-FUNCTION
MICROPHONE WITH DTMF
(E: Europe version)

MC-45DM/45DME



DC LINE
NOISE FILTER
(G:High capacitance type)

PG-3G

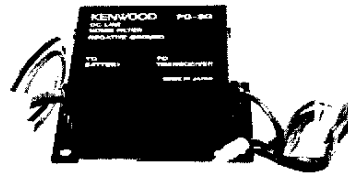

DC POWER BAND UNIT
CABLE

PG-3B

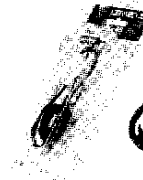

PG-2N



UT-28S

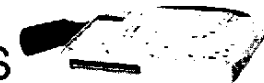

UT-50S

UT-220S (U.S.A./Canada only)

UT-1200

UT-440S (U.S.A./Canada only)

MOBILE SPEAKER

SP-41



COMMUNICATIONS
SPEAKER

SP-50B



DC POWER SUPPLY

PS-33

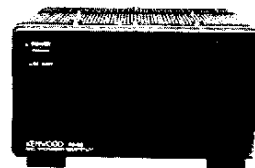

MOBILE
BRACKET

MB-14

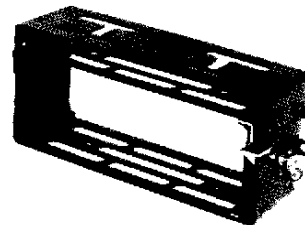

MODULAR PLUG
MICROPHONE SWITCH

MJ-89

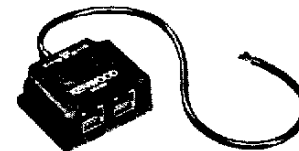

MICROPHONE
PLUG ADAPTOR

MJ-88



OPTIONAL ACCESSORIES

INSTALLING OPTIONAL ACCESSORIES

CTCSS Unit (TSU-7)

CAUTION

Before beginning installation, disconnect the DC power supply, or damage may occur to the equipment.

Press the release button on the left of the Front Panel. Pull the Front Panel forward from the left, then remove it completely. Be careful with the cord connecting the Front Panel to the Main Unit. (Fig. 1)

Unplug the microphone from the Main Unit.

Remove the cover using a small flat-blade screwdriver. (Fig. 1)

Remove the backing from the cushion provided with the TSU-7, and attach the cushion to the back of the TSU-7 as shown in Fig.2.

Remove the backing from the other side of the cushion. (Fig. 2)

Insert the CTCSS connector into the TSU-7 connector, and gently push down until fully seated.

Replace the cover.

Replace the Front Panel. Take care not to pinch the connecting cord. The cord is easier to manage when it is pressed into the groove on the back of the panel.

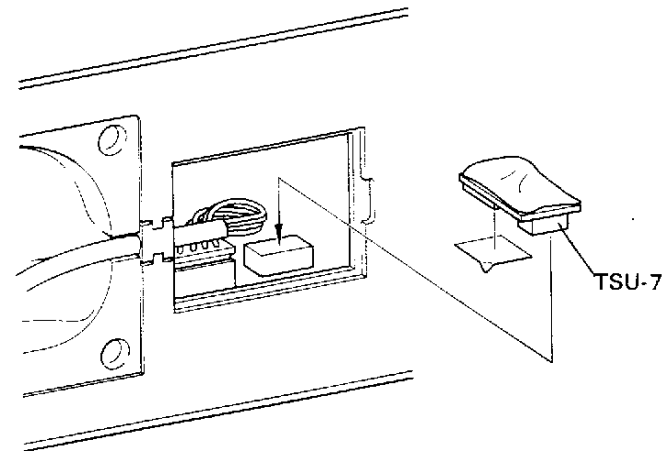
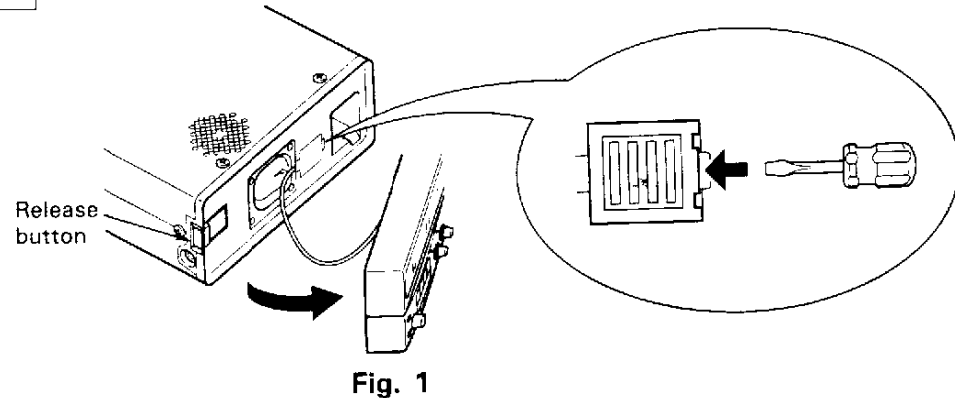

Fig. 2

Detachable Front Panel Kit (DFK-4/7)

CAUTION

Before beginning installation, disconnect the DC power supply, or damage may occur to the equipment.

Press the release button on the left of the Front Panel. Pull the Front Panel forward from the left, then remove it completely. Be careful with the cord connecting the Front Panel to the Main Unit. (Fig. 1)

Unplug the microphone from the Main Unit.

Remove the cover using a small flat-blade screwdriver. (Fig. 1)

Unplug the cord which connects the Front Panel and the Main Unit, and connect the DFK-4/7 Front Panel cable to the transceiver. (Fig. 2)

Install the cover.

Remove the cover from the Front Panel using a small flat-blade screwdriver. (Fig. 3)

Unplug the cord connected to the Front Panel.

Connect the DFK-4/7 Front Panel cable to the Front Panel. (Fig. 4)

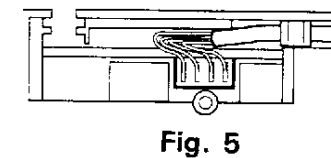
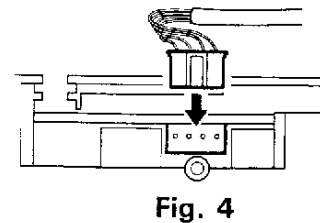
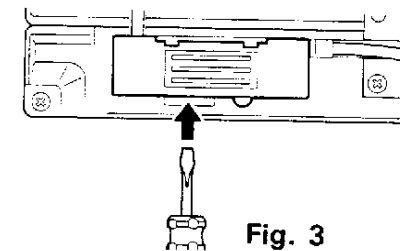
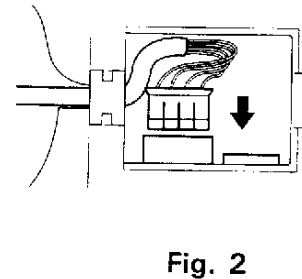
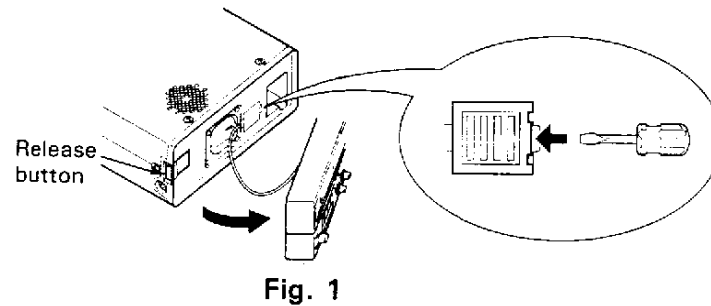

Install the bushing on the panel cable into the Front Panel, dress the cable as shown (Fig. 5), and connect the DFK-4/7 microphone extension cable to the microphone connector. Insert the connector until it clicks.

Connect the microphone to the other connector on the microphone cable.

Attach the connector to a safe, convenient spot with a screw.

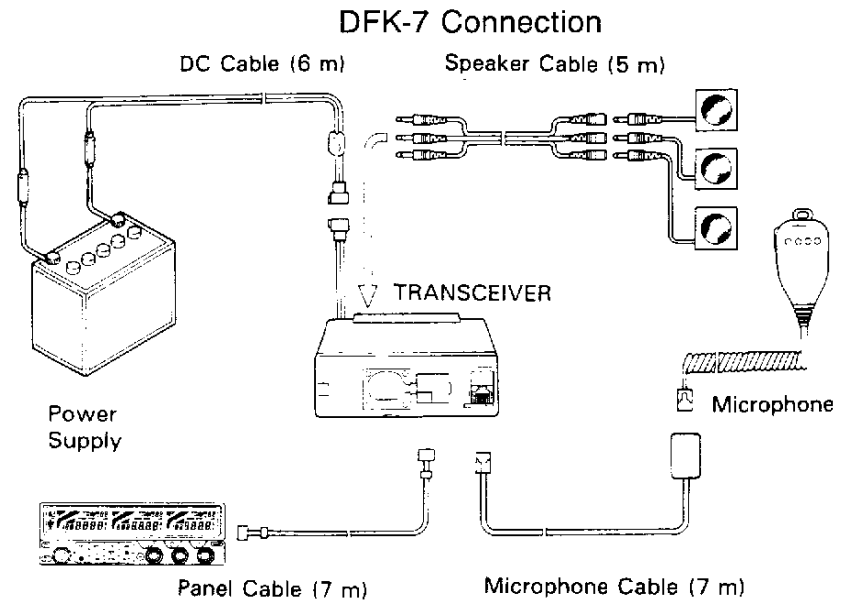
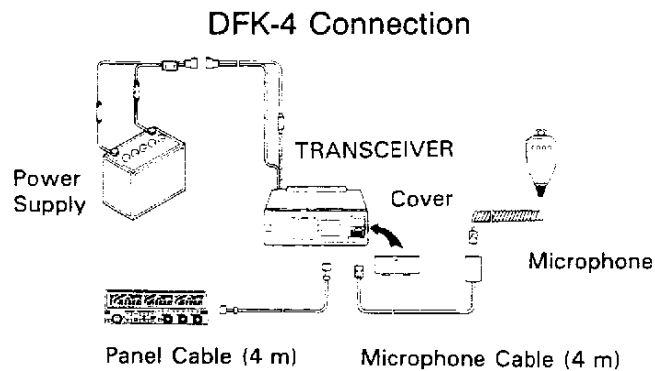

Detachable Front Panel Kit (DFK-3)

This kit is used to divide the Front Panel into separate Display and Control sections. See pages 89 and 90 for the connection illustrations and details for the DFK-4/7. This section explains DFK-3 connection.

Press the release button on the left of the Front Panel. (Fig. 1)

Remove the transceiver section cover with a small flat-blade screwdriver. (Fig. 1)

Carefully unplug the cable from the transceiver section. (Fig. 2)

The transceiver section is separated now from the Front Panel.

Remove the two Front Panel covers with a small flat-blade screwdriver. (Fig. 3)

Carefully disconnect the cable from the Front Panel. (Fig. 4)

Carefully disconnect the cable connecting the Display section and Control section. (Fig. 4)

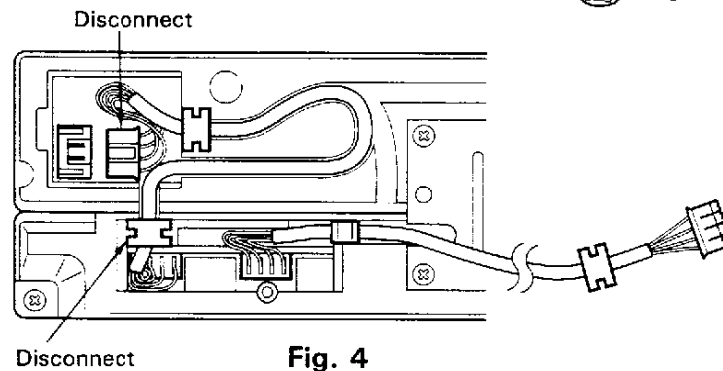
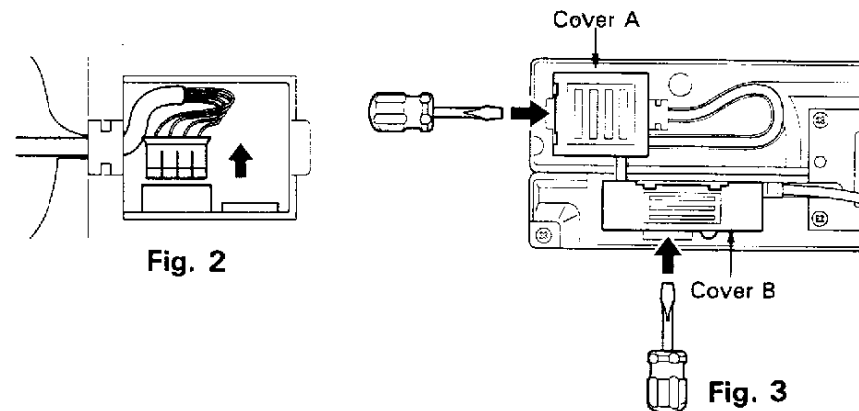
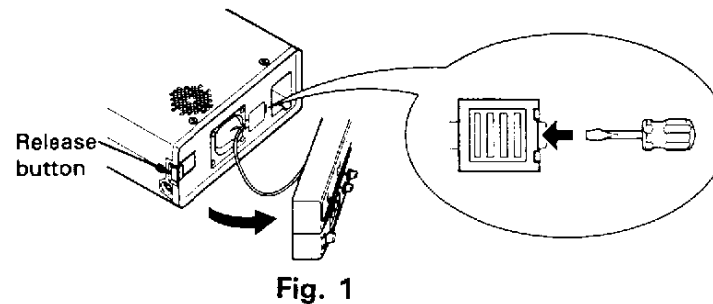

Remove the four screws from the plate joining the Display section and Control section. (Fig. 5)

Connect the DFK-3 cable to the Display section. (Fig. 6)

Install the cover (A).

Install the other end of the DFK-3 on the Control section, CONT B terminal. (Fig. 6)

Connect the DFK-4 or -7 panel cable to the CONT A terminal. (Fig. 7)

Install the cover (B).

Connect the other end of the DFK-4 or -7 panel cable to the transceiver section. (Fig. 8)

Install the transceiver section cover.

Attach the Display and Control sections in positions where they can be seen and operated both safely, and conveniently. Attach the units with Velcro fasteners.

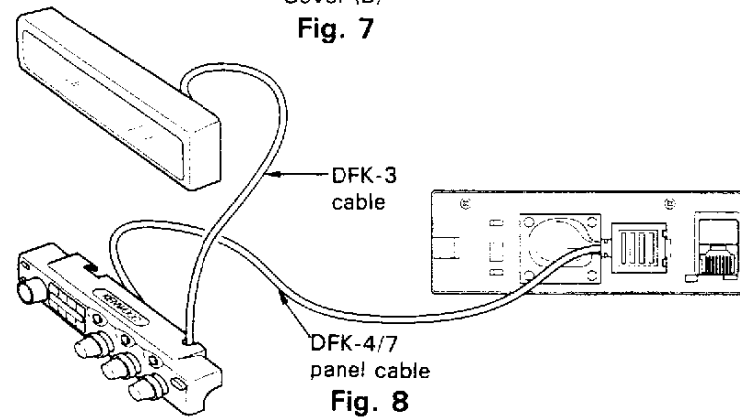
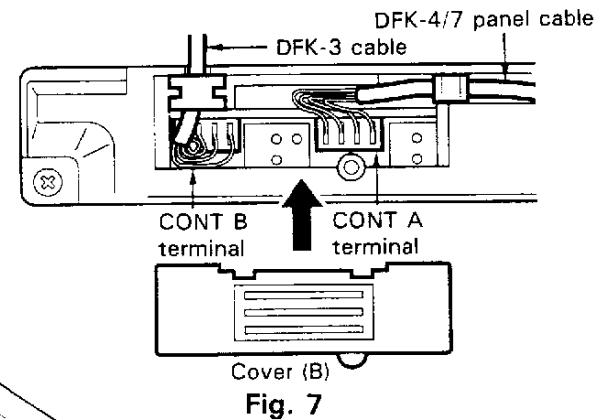
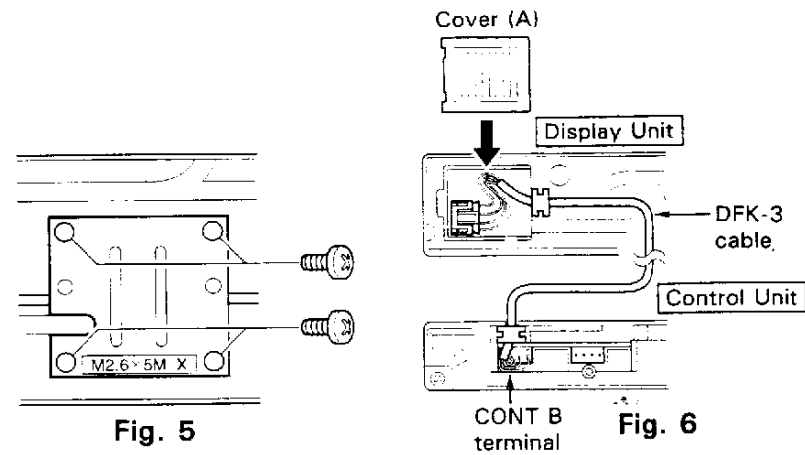

Front Panel Bracket

Remove the four screws from the plate joining the Display section and Control section, and install the bracket in place of the plate.

Even when the Display and Control sections are separated, one of the sections can be installed using this bracket.

Install the bracket using the supplied flat washers and screws.

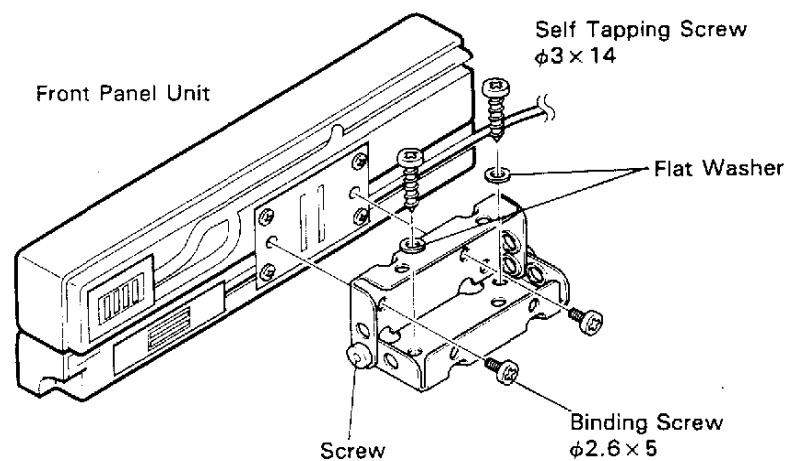

BAND UNITS

Any of the following optional Band Units may be installed in the TM-642A or TM-742A/TM-742E with the exception that the UT-220S may only be installed in the TM-742A (U.S.A./Canada) version and the UT-440S may only be installed in the TM-642A. Also, band units must be installed in the top spare slot in the transceiver otherwise Kenwood cannot guarantee correct performance of the units. The same instructions apply for both the Tribander and the Dual Bander.

UT-28S: 28MHz BAND UNIT

UT-50S: 50MHz BAND UNIT

UT-220S: 220MHz BAND UNIT

(U.S.A./Canada only)

UT-440S: 440MHz BAND UNIT

(U.S.A./Canada only)

UT-1200: 1200MHz BAND UNIT

CAUTION

Before installing any Band Unit, disconnect the DC power cable.

TOOLS REQUIRED:

2.6 mm Phillips screwdriver

3.0 mm Phillips screwdriver

Remove the covers

- ① Remove the four screws securing the top cover.
- ② Loosen the two screws on each side of the transceiver.
- ③ Remove the four screws securing the bottom cover.
- ④ Remove the top and bottom covers.

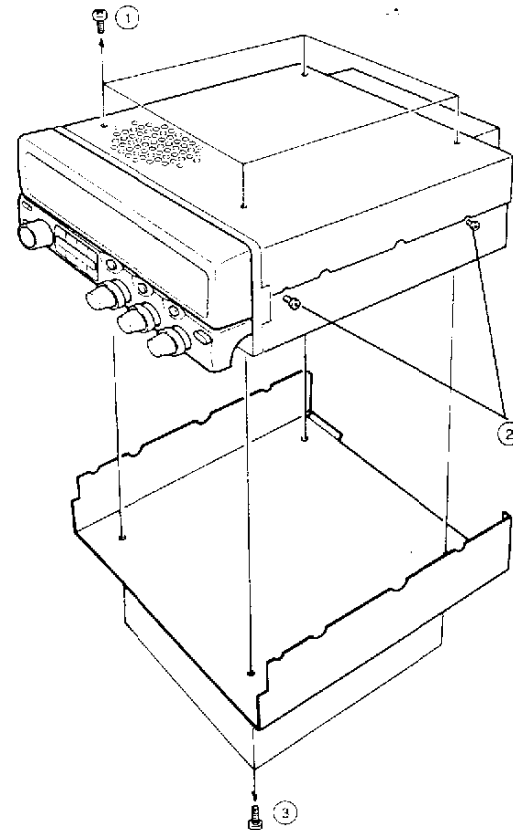

Remove the cooling fan assembly.

- ① Unplug the connector.
- ② Remove the four screws securing the fan case.
- ③ Remove the fan case.

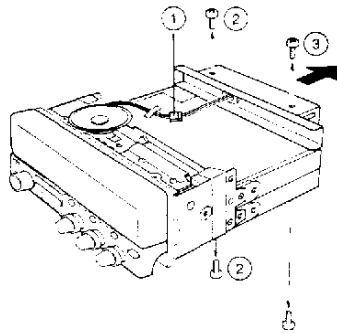

Remove the spacer.

- ① Remove the two long screws securing the spacer.
- ② Remove the spacer.

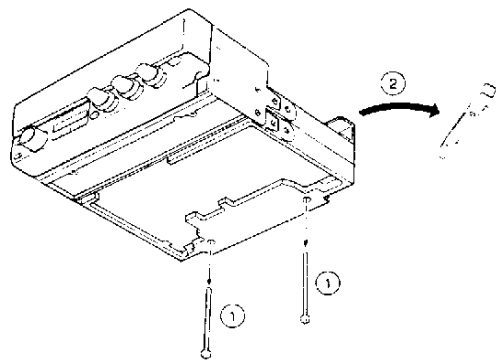

Be sure to unplug the DC power cable before removing the terminal plate.

- ① Remove the two screws from the side of the present two Band Units.
- ② Remove the plate.

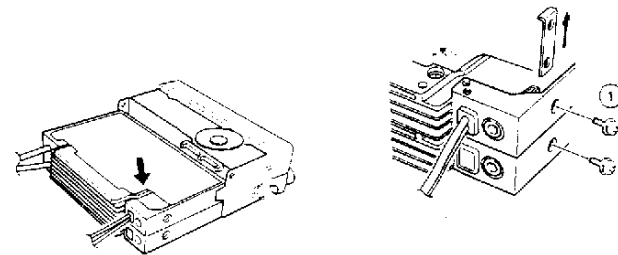

Insert the new Band Unit.

Insert the new Band Unit as shown.

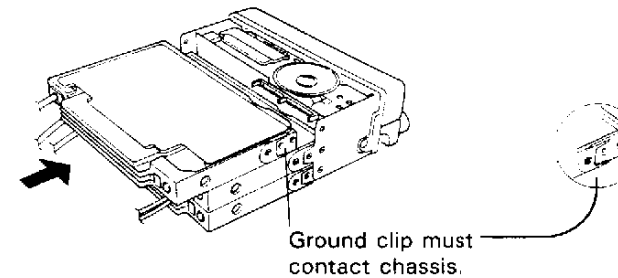

Tighten the new Band Unit.

- ① Insert and tighten the two side screws to secure the new Band Unit in place.
- ② Insert the two long screws.
- ③ Tighten the two long screws while holding the nuts and lock washers from the opposite side.

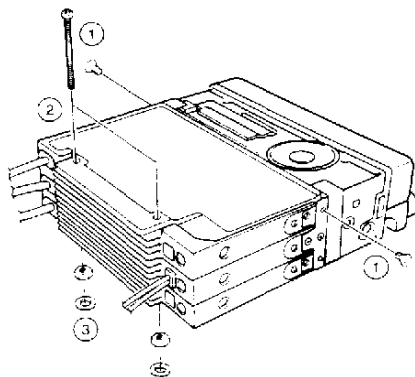

Attach the 3-hole terminal plate.

- ① Position the 3-hole terminal plate.
- ② Insert and tighten three screws from the side of the transceiver.

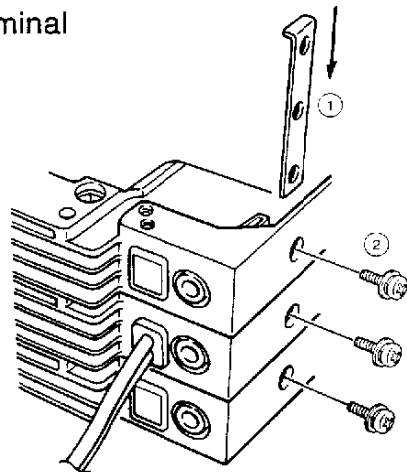

Replace the cooling fan assembly.

- ① Align the fan cable with the rear case slot.
- ② Position the cooling fan assembly.
- ③ Insert and tighten the four screws.

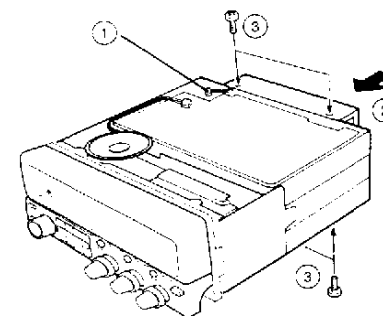

Attach the connector.

- ① Attach the connector.
- ② Route the cable in the chassis slot.
- ③ Attach the two supplied protective covers on the cable.

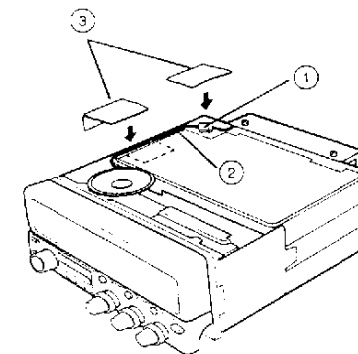

Replace the cases.

- ① Position the top and bottom covers.
- ② Insert and tighten the four top cover screws.
- ③ Insert and tighten the four bottom cover screws.
- ④ Tighten the four side screws.

Notes

After installation, the following parts will remain.

Terminal plate



2 spacer screws



A spacer



If you have more or less than the specified leftovers, re-check your installation BEFORE attaching the DC power cable or turning the POWER switch ON.

Preliminary Checkout

Use a DC power supply to check the following:

- ① Connect the DC power cable.
- ② Turn the POWER switch ON.

If there is no frequency on the Display after the one second turn-on delay, immediately disconnect the DC power cable. Then check the following.

- a. Make sure the Positive (+) and Negative (-) lead polarity is correct when connecting the cable to the DC supply.
- b. Check the cable connecting the Front Panel and the Main Unit.
- c. Check the fuse.

If the fuse opens, check that each conductor has not been damaged by a short circuit or other problems. Then replace with a new fuse of the same type and rating.

Only when a frequency display appears after the one second turn-on delay, proceed with the next step.

To activate the optional band unit, reset the memory for the band.

- ① Turn the POWER switch OFF.
- ② Press and hold the F key and the BAND SEL key for the band, then turn ON the POWER switch. After one second all indicators for the band will light.

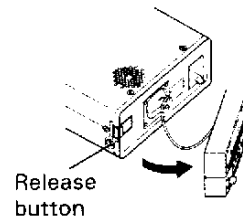

- ③ Confirm all indicators appear, then release the F key and the BAND SEL key. The initial settings will be displayed, the PTT indicator will flash three times, and a beep will sound, then the memory reset will be finished.

Additional Band Unit Functions

The same instructions apply for both the Tribander and the Dual Bander. An optional Band Unit will add the following functions to the transceiver.

Frequency Step Selection

YES : Step size is available.

NO : Step size is not available.

Step Size [kHz]	5	10	15	20	12.5	25
28 MHz band	YES	YES	YES	YES	NO	YES
50 MHz band	YES	YES	YES	YES	NO	YES
220 MHz band	YES	YES	YES	YES	YES	YES
440 MHz band	YES	YES	YES	YES	YES	YES
1200 MHz band	NO	YES	NO	YES	YES	YES

Changing the frequency step size on the 28MHz or 50MHz bands will never alter the transceiver frequency. This means, in some cases, you may not be able to return to a previously used transceiver frequency while the new step size is selected. See page 51 for more information.

Microprocessor Initialization

Band	28MHz	50MHz	220MHz	440MHz	1200MHz
VFO, Call and Memory channel 1 frequency	29.000 MHz	51.000 MHz	220.000 MHz	440.000 MHz	1240.000 MHz
Frequency step	10kHz	10kHz	20kHz	25kHz	25kHz
Tone frequency	88.5Hz	88.5Hz	88.5Hz	88.5Hz	88.5Hz

MHz key (UT-28S installed, except U.S.A./Canada version)

The displayed frequency will change as shown when the MHz key is incremented or decremented.

⇔ 28 ⇔ 29 ⇔ 28 ⇔ 29 ⇔

Transmitter Offsets

	28 MHz	50 MHz	220 MHz	440 MHz	1200 MHz
+	+ 100 kHz	+ 1 MHz	+ 1.6 MHz	+ 5 MHz	+ 12 MHz
-	- 100 kHz	- 1 MHz	- 1.6 MHz	- 5 MHz	- 12 MHz
- -	-	-	-	-	- 20 MHz

SPECIFICATIONS

The specifications of the TM-642A, TM-742A/E, and TM-942A are given below.

		UT-28S	UT-50S	144 MHz BAND	UT-220S or 220 MHz BAND	UT-440S or 430/440 MHz BAND	UT-1200 or 1200 MHz BAND	
GENERAL	Frequency range (MHz)	28 ~ 29.7	50 ~ 54	144 ~ 148	220 ~ 225	430 ~ 440/438 ~ 450	1240 ~ 1300	
	Mode	F3E (FM)						
	Antenna impedance	50 Ω						
	Operating temperature	- 20°C ~ + 60°C (- 4°F ~ + 140°F)						
	Power requirements	13.8 V DC ± 15% (11.7 V ~ 15.8 V)						
	Ground	Negative						
	Current drain	Transmit mode	Less than 11.5 A				Less than 10.0 A	Less than 6.5 A
		Receive mode	Less than 1.2 A					
	Frequency stability	Less than ± 10 ppm						Less than ± 3 ppm
	Dimensions (W x H x D)	150 x 50 x 175 mm						
Weight	TM-742A/742E/642A: 1.5 kg TM-942A: 1.8 kg							
TRANSMITTER	Output power	HI	50 W		25 W	35 W	10 W	
		MID	10 W					
		LOW	Approx. 5 W					
	Modulation	Reactance modulation						
	Spurious radiation	Less than - 60 dB						Less than - 50 dB
	Maximum frequency deviation	± 5 kHz						
	Audio distortion (at 60% modulation)	Less than 3%						
	Microphone impedance	600 Ω						

SPECIFICATIONS

		UT-28S	UT-50S	144 MHz BAND	UT-220S or 220 MHz BAND	UT-440S or 430/440 MHz BAND	UT-1200 or 1200 MHz BAND	
R E C E I V E R	Circuitry	Double conversion superheterodyne						
	Intermediate frequency	1st	8.83 MHz	10.595 MHz	10.7 MHz	30.825 MHz	21.6 MHz	59.7 MHz
		2nd	455 kHz					
	Sensitivity (12 dB SINAD)		Less than 0.16 μ V (-16 dB μ) ※					
	Selectivity - 6 dB		More than 10 kHz	More than 12 kHz				
	Selectivity - 60 dB		Less than 24 kHz					Less than 36 kHz
	Squelch sensitivity		Less than 0.1 μ V (-20 dB μ)					
	Output (5% distortion)		More than 2 W (8 Ω load)					
	External speaker impedance		8 Ω					

※ 1240 MHz to 1260 MHz: Less than 0.22 μ V (-13dB μ)

NOTE: 1. Circuits and ratings are subject to change without notice, due to developments in technology.
2. Recommended duty cycle: 1 minute Transmission, 3 minutes Reception.

QUICK REFERENCE

Note : The plus symbol (+) means press two keys simultaneously. "Then" means press two keys in sequence. "(1 second)" means press the key for longer than one second.

Basic key functions (press)

key	Functions
VFO	VFO mode
MR	Memory channel recall
CALL	Call channel recall
SHIFT	Select transmitter offset
REV	Reverse function on or off
LOW	Transmit output power selection
MUTE	Mute function on or off
DTSS	DTSS or Page on or off
TONE	Subaudible tone on or off
F	Select a function by pressing the F key with another key.
RC	Remote control by DTMF microphone on or off
POWER	Turns the power on or off.

COMMON

TO DO THIS	PRESS	PAGE
All band memory reset	MR + POWER	34
Individual band memory reset	(F + BAND SEL) + POWER	35
All band VFO reset	VFO + POWER	35
Individual band VFO reset	(VFO + BAND SEL) + POWER	35
Microphone key function change	Microphone key + POWER	54
Frequency Step Selection	F + REV	51
Automatic power off function on or off	F (1 second) then MHz	56
DIMMER (DIM)	F then LOW	56
Beep Tone Level Adjustment	F (1 second) then REV	57
Clearing unused Band Displays	F (1 second) then BAND SEL	57

Receiver operation

<i>TO DO THIS</i>	<i>PRESS</i>	<i>PAGE</i>
Automatic band change function on or off	F then MUTE	27
Microprocessor squelch control function on or off	MHz + POWER	28
S-meter squelch control function on or off	LOW + POWER	28
Attenuator function on or off (28 MHz and 50 MHz band only)	F then DTSS	29
Automatic lock tuning function on or off (1200 MHz band only)	F then DTSS	30
Receive audio output band selection	F (1 second) then C.SEL	31

Transmitter operation

Time-out timer function on or off	F (1 second) then LOW	32
TX. alert function on or off	F + PTT	32
Bandwidth selection (28 MHz band only)	(F + LOW) + POWER	33
Locking the transmit band	BAND SEL + POWER	33

Memory

<i>TO DO THIS</i>	<i>PRESS</i>	<i>PAGE</i>
Normal repeater offset or simplex channel entry	—	25
Odd split memory channel entry	—	26
Memory channel recall	MR	26
Rewriting call channel data	F then CALL	36
Memory bank link	F then C.SEL	36
Separating linked memory banks	F then C.SEL	37
Memory consolidation	F + LOW	38
Clearing a memory channel	F + MR	39
Clearing an entire memory bank	F + BAND SEL	39
Memory shift	F then VFO	39

SCAN

TO DO THIS	PRESS	PAGE
Hold/Resume selection	F (1 second) then VFO	41
Band Scan (Must be in VFO mode)	C.SEL (1 second)	41
Programmable Band Scan	VFO (1 second)	42, 43
MHz Scan	MHz (Tuning)	43
Memory Scan in-band (Must be in memory channel recall mode)	MR (1 second)	43
Memory Scan in-bank (Must be in memory channel recall mode)	C.SEL (1 second)	43
Locking out memory channels	F (1 second) then MR	44
CALL/VFO Scan (Must be in VFO mode)	CALL (1 second)	44
CALL/Memory Channel Scan (Must be in memory channel recall mode)	CALL (1 second)	44
V/M/C (VFO/Memory/Call) Scan (Must be in CALL channel recall mode)	C.SEL (1 second)	44
Automatic Memory Scan (Must be in VFO mode)	F + C.SEL	45

Repeater operation

TO DO THIS	PRESS	PAGE
Selecting the offset direction	SHIFT	46
Automatic offset function on or off	(VFO+REV) + POWER	46
Selecting tone frequencies	F (1 second) then TONE	48
Tone function operating	TONE	48
DTMF memory	—	49

Operation as a Repeater

Cross-Band repeat mode on or off	F (1 second) then MUTE	60
Fixed-Band repeat mode on or off	F (1 second) then MUTE	60
Dual input repeater mode on or off	F (1 second) then MUTE	60
Hang Time Selection	(VFO+MUTE) + POWER	60

Remote control

TO DO THIS	PRESS	PAGE
Pushbutton control using the DTMF microphone	RC	61, 62
Control by external DTMF signal	F (1 second) then RC	75, 76

CLOCK

Setting Time and Date	(F + TONE) + POWER	66
Time check	C.SEL	66
Calender display on or off	—	67
Stopwatch	—	67
Alarm function on or off	—	68
Time on switch on or off	—	69
Time off switch on or off	—	69

CTCSS operation

Selecting subaudible tone frequency	F (1 second) then TONE	70
CTCSS function on or off	TONE	71

DTSS operation

TO DO THIS	PRESS	PAGE
DTSS function on or off	DTSS	72
Selecting DTSS codes (Must be in DTSS mode)	F (1 second) then DTSS	72
Selecting delay time	F + DTSS	74
Intercom using DTSS	F then RC	75

PAGE operation

PAGE function on or off	DTSS	78
Selecting PAGE codes	F (1 second) then DTSS	78, 79
Code lockout (Must be in PAGE mode selection mode)	MR	81
Answer-back function on or off	F + CALL	81
Automatic PAGE canceling function on or off	F + SHIFT	81

Tone Alert operation

Tone Alert function on or off	F then TONE	82
Alarm sound selection	(F + SHIFT) + POWER	83

Memory Setup

M.CH	RX. Freq.	TX. Freq.	offset	TONE/ CTCSS	DTSS	REV
CALL			S.+-	<input type="checkbox"/>	<input type="checkbox"/>	<input type="checkbox"/>
CALL			S.+-	<input type="checkbox"/>	<input type="checkbox"/>	<input type="checkbox"/>
CALL			S.+-	<input type="checkbox"/>	<input type="checkbox"/>	<input type="checkbox"/>
			S.+-	<input type="checkbox"/>	<input type="checkbox"/>	<input type="checkbox"/>
			S.+-	<input type="checkbox"/>	<input type="checkbox"/>	<input type="checkbox"/>
			S.+-	<input type="checkbox"/>	<input type="checkbox"/>	<input type="checkbox"/>
			S.+-	<input type="checkbox"/>	<input type="checkbox"/>	<input type="checkbox"/>
			S.+-	<input type="checkbox"/>	<input type="checkbox"/>	<input type="checkbox"/>
			S.+-	<input type="checkbox"/>	<input type="checkbox"/>	<input type="checkbox"/>
			S.+-	<input type="checkbox"/>	<input type="checkbox"/>	<input type="checkbox"/>
			S.+-	<input type="checkbox"/>	<input type="checkbox"/>	<input type="checkbox"/>
			S.+-	<input type="checkbox"/>	<input type="checkbox"/>	<input type="checkbox"/>
			S.+-	<input type="checkbox"/>	<input type="checkbox"/>	<input type="checkbox"/>
			S.+-	<input type="checkbox"/>	<input type="checkbox"/>	<input type="checkbox"/>
			S.+-	<input type="checkbox"/>	<input type="checkbox"/>	<input type="checkbox"/>
			S.+-	<input type="checkbox"/>	<input type="checkbox"/>	<input type="checkbox"/>
			S.+-	<input type="checkbox"/>	<input type="checkbox"/>	<input type="checkbox"/>
			S.+-	<input type="checkbox"/>	<input type="checkbox"/>	<input type="checkbox"/>
			S.+-	<input type="checkbox"/>	<input type="checkbox"/>	<input type="checkbox"/>
			S.+-	<input type="checkbox"/>	<input type="checkbox"/>	<input type="checkbox"/>

M.CH	RX. Freq.	TX. Freq.	offset	TONE/ CTCSS	DTSS	REV
			S.+-	<input type="checkbox"/>	<input type="checkbox"/>	<input type="checkbox"/>
			S.+-	<input type="checkbox"/>	<input type="checkbox"/>	<input type="checkbox"/>
			S.+-	<input type="checkbox"/>	<input type="checkbox"/>	<input type="checkbox"/>
			S.+-	<input type="checkbox"/>	<input type="checkbox"/>	<input type="checkbox"/>
			S.+-	<input type="checkbox"/>	<input type="checkbox"/>	<input type="checkbox"/>
			S.+-	<input type="checkbox"/>	<input type="checkbox"/>	<input type="checkbox"/>
			S.+-	<input type="checkbox"/>	<input type="checkbox"/>	<input type="checkbox"/>
			S.+-	<input type="checkbox"/>	<input type="checkbox"/>	<input type="checkbox"/>
			S.+-	<input type="checkbox"/>	<input type="checkbox"/>	<input type="checkbox"/>
			S.+-	<input type="checkbox"/>	<input type="checkbox"/>	<input type="checkbox"/>
			S.+-	<input type="checkbox"/>	<input type="checkbox"/>	<input type="checkbox"/>
			S.+-	<input type="checkbox"/>	<input type="checkbox"/>	<input type="checkbox"/>
			S.+-	<input type="checkbox"/>	<input type="checkbox"/>	<input type="checkbox"/>
			S.+-	<input type="checkbox"/>	<input type="checkbox"/>	<input type="checkbox"/>
			S.+-	<input type="checkbox"/>	<input type="checkbox"/>	<input type="checkbox"/>
			S.+-	<input type="checkbox"/>	<input type="checkbox"/>	<input type="checkbox"/>
			S.+-	<input type="checkbox"/>	<input type="checkbox"/>	<input type="checkbox"/>
			S.+-	<input type="checkbox"/>	<input type="checkbox"/>	<input type="checkbox"/>
			S.+-	<input type="checkbox"/>	<input type="checkbox"/>	<input type="checkbox"/>
			S.+-	<input type="checkbox"/>	<input type="checkbox"/>	<input type="checkbox"/>

QUICK REFERENCE

KENWOOD