

KENWOOD

WIDE BAND RECEIVER

RZ-1

INSTRUCTION MANUAL

KENWOOD CORPORATION

Thank you for purchasing this new receiver.

IMPORTANT: _____

Please read this instruction manual carefully before placing your receiver in service.

SAVE THIS INSTRUCTION MANUAL.

The following explicit definitions apply in this manual:

- Note** : If disregarded, inconvenience only, no risk of equipment damage or personal injury.
- Caution** : Equipment damage may occur, but not personal injury.

CONTENTS

1. BEFORE OPERATION	4
2. SPECIFICATIONS AND ACCESSORIES	6
3. INSTALLATION INSTRUCTIONS.....	7
4. OPERATION	11
OPERATING CONTROLS	
RECEIVER OPERATION.....	15
Reception	
Frequency Selection	
MODE Selection	17
MEMORY.....	18
Microprocessor Memory Back-up	

Microprocessor Initialization.....	19
Memory Channel	
Memory Contents	
Memory Entry	
Memory Recall	20
Programmable Band	
Memory Shift.....	22
SCAN	
Scan Option	
Hold/Resume Condition	
All Band Scan	23
Programmable Band Scan	
Memory Channel Scan.....	24
Memory Channel Group Scan	
Memory Channel Lockout	
MESSAGE MEMORY	25
Message Entry	
Message Memory Recall.....	27
5. MAINTENANCE.....	29
Service	
In Case of Difficulty.....	30
6. SCHEMATIC DIAGRAM.....	another sheet
7. OPTIONAL ACCESSORIES	31
8. REFERENCE.....	32

1. BEFORE OPERATION

Safety precautions

Never remove the case unless instructed to do so in this Instruction Manual. If the internal parts are touched accidentally, a serious electric shock might occur.



Never touch internal parts.

If a metal object, such as a hair pin or a needle, comes into contact with the power socket on the rear panel, a dangerous electric shock may result. Never permit children to put anything, especially metal objects, inside this unit.



The power requirement is 13.8 VDC.

Never attempt connection to a 24 VDC source.

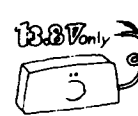

DC Power Supply:

Touching the power plug when your hands are wet may result in a serious electric shock.



Never touch with wet hands.

DC Power Supply:

Never pull, bend or extend the power cord. This could damage the power cord, resulting in a broken cord or short-circuit.



Always grasp the plug.

Installation notes

Do not place this unit in a location that is exposed to direct sunlight, near a heating appliance, etc.

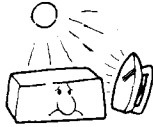

Do not store or use the unit in a dusty location or in a moist atmosphere. Select a location where there is good ventilation.

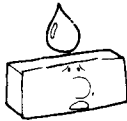

In case of an abnormal odor

If an abnormal odor or smoke is detected, immediately turn the power OFF and pull out the power cord. Contact your dealer or nearest Service Station.

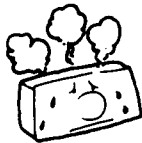

To maintain good ventilation, do not put books or papers on the unit.



Choose a location that is relatively free from vibration.

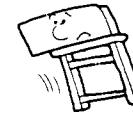

Cleaning

Do not use volatile solvents such as alcohol, paint thinner, gasoline, benzene, etc. to clean the cabinet. Use a silicone cloth or a clean dry cloth.



Silicone cloth Thinner Benzene

2. SPECIFICATIONS AND ACCESSORIES

2-1. SPECIFICATIONS

Frequency Range	U.S.A. version : 500 kHz ~ 824 MHz Other market version : 500 kHz ~ 905 MHz	
Mode	A3E (AM) F3E (FM-N, FM-W) C3F (T.V. visual, NTSC) (U.S.A. version)	
Antenna Impedance	50 ~ 300 Ω (50 Ω nominal), Unbalanced (ANT 1 and ANT 2)	
Power Requirement	11 ~ 16 VDC (13.8 VDC nominal)	
Ground	Negative	
Current Drain: AUDIO OUTPUT (1 W)	1 A	
Operating Temperature	- 10°C ~ + 60°C (14°F ~ 140°F)	
Dimensions (W×H×D)	180×50×176 mm (7.0"×2"×6.9")	
Weight	1.5 kg (3.3 lbs)	
Frequency Step	Manual Mode	5 kHz, 12.5 kHz, 20 kHz, 25 kHz
Sensitivity	AM (10 dB S/N)	5 μV
	Medium-wave broadcasts	Less than 10 μV
	FM-N (12 dB SINAD)	Less than 6 μV (less than 60 MHz) Less than 3 μV (more than 60 MHz)
	FM-W (12 dB SINAD)	Less than 1 μV (83 MHz)
Squelch Sensitivity (FM-N mode)	Less than 0.1 μV	
Memory Channel	100	
Output Power	EXT.SP	More than 2 W (across 8 Ω load 5% distortion, FM 1 kHz, ±3 kHz DEV)
	LINE OUT	150 mV
	T.V. visual (U.S.A version)	1 V _{p-p} , 75 Ω
FM-W STEREO Separation	More than 30 dB (1 kHz)	

Note: _____

Circuit and ratings are subject to change without notice due to advancement in technology.

2-2. ACCESSORIES

Unpack your new receiver carefully, and confirm that the accessories listed below are included in the box.

Antenna cable	T90-0362-05	1 ea.
Mobile mounting kit	J21-3437-04	2 ea.
Screws.....	N99-0322-05.....	1 set
Foot	J02-0441-05	4 ea.
Connector.....	E31-3366-05	1 ea.
DC power cable.....	E30-2053-05	1 ea.
Fuse (1.5A).....	F05-1521-05	1 ea.
Warranty card.....		1 ea.
Instruction manual.....	B50-8196-XX.....	1 copy

After unpacking

Shipping container:

Save the boxes and packing in the event your unit needs to be transported for remote operation, maintenance, or service.

3. INSTALLATION INSTRUCTIONS

3-1. INSTALLATION

3-1-1. Fixed Installation

Foot installation

Attach the feet (4 pcs.) using the following procedures.

1. Place the radio so that the bottom is up.
2. Place each foot on the bottom cover so that the hole in the feet line up with the holes in the bottom cover.
3. Insert a snap fastener into the hole of each foot.
(Make sure the pin is not inserted too far or the fastener will not go in properly.)
4. Push the pin down securely to complete the installation.

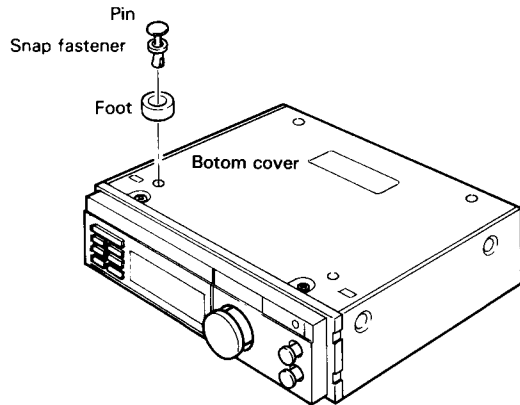

3-1-2. Mobile Installation

Mounting bracket

CAUTION:

When installing the receiver in a vehicle, consider ease of operation and safety when selecting the installation location.

Make sure that the receiver will not slip out of place while operating the vehicle.

1. Secure the receiver under the dashboard using the supplied mounting bracket. Install the bracket as shown below.

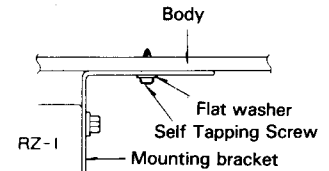
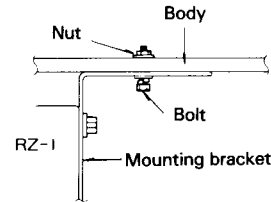

3-2. CONNECTIONS

3-2-1. Precautions

1. Before connecting or disconnecting the power connector, be sure to turn off the power switches of the receiver, engine key, and the DC power supply.
2. Observe the polarity of the cable. The receiver operates on 13.8 VDC, negative ground. Battery polarity must be correct. The power cable is color coded:
Red → + (Positive) polarity
Black → - (Negative) polarity

Notes:

1. Before installing the power cable, be sure to remove the negative lead from the battery for safety.
 2. After installation and wiring, be sure to double check for correct installation before reconnecting the negative lead to the battery terminal.
 3. If the fuse opens, be sure to check each conductor for damage.
After you have checked the cable and determined that there is no problem replace the FUSE with one of the same rating.
 4. After completing the wiring, wrap the fuse holder with tape to protect against moisture.
 5. Do not remove the fuse even if the power cable is too long.
-

3-2-2. Antenna

(A) Antenna

The installation of the antenna and a good earth grounding is important for optimum reception of short-wave, broadcast or amateur radio signals. A good outdoor antenna will provide the best results.

A simple method is to install the wire antenna as high as possible, it must be extended to its full length for good results.

3-2-3. Connect with DC Power Cable to DC Power Supply

Connect the supplied power cable with fuse to a regulated DC power supply (13.8 VDC).

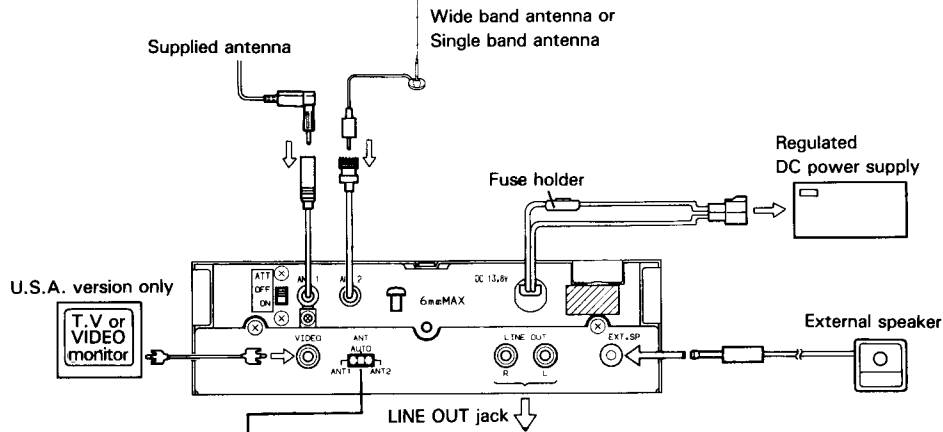

ANT 1

Use this position when a Mobile antenna is connected to the ANT 1 connector.

ANT 2

Use this position when a wide band antenna or single band antenna is connected to the ANT 2 connector.

AUTO

Use this position when both antennas are connected.

Before connecting the LINE OUT jack, to interrupt any signal to the built-in speaker install the supplied connector as follows.

1. Remove the 3 screws securing the top cover.
2. Remove the 2 screws on each side of the cover.
3. Gently remove the top cover. Be sure not to disconnect the wire to the speaker.
4. Insert the supplied connector as shown.
5. Replace the cover and tighten the screws to complete the installation.

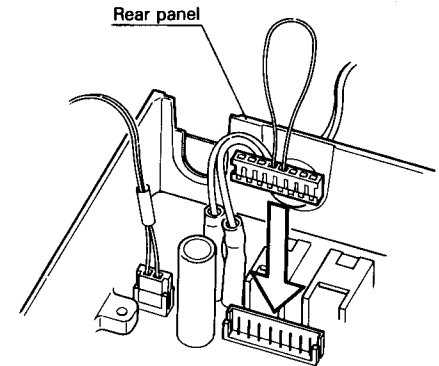

3-2-4. Mobile

A. Battery connection

Connect the supplied power cable with fuse directly to the battery terminals. Connecting to the cigarette lighter socket can cause a poor connection, and excessive voltage drop, and lead to poor performance.

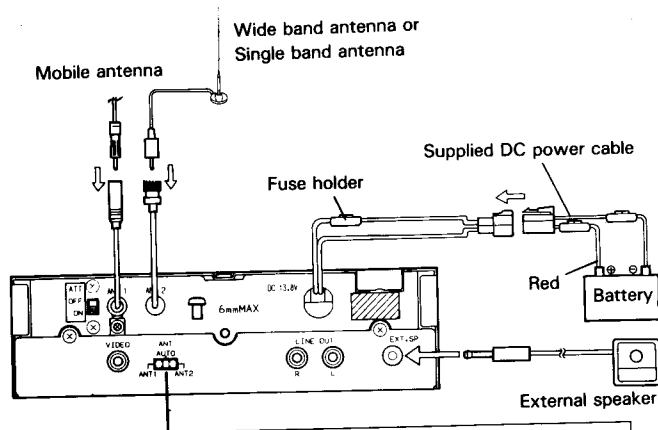

ANT 1

Use this position when a Mobile antenna is connected to the ANT 1 connector.

ANT 2

Use this position when a wide band antenna or single band antenna is connected to the ANT 2 connector.

AUTO

Use this position when both antennas are connected.

B. Ignition noise

This receiver is designed to suppress ignition noise; however, if excessive noise is present, it may be necessary to use suppressor spark plugs (with resistors), or an external noise filter. Contact your dealer for information regarding these devices.

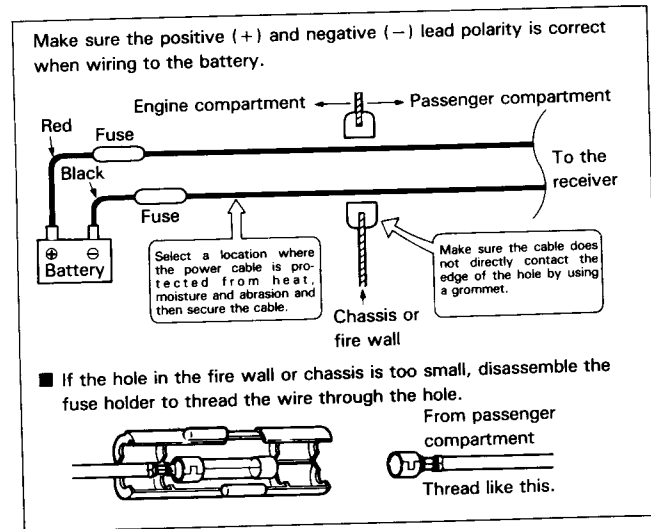

4. OPERATION

4-1. Operating Controls

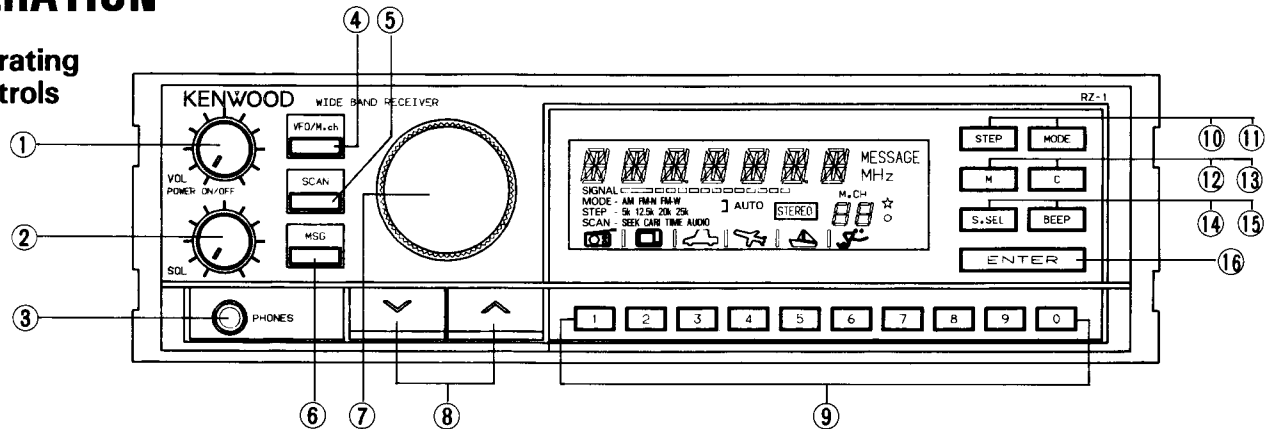

① VOL control/POWER switch

The volume control and power switch are combined. Rotating the control clockwise will turn ON the receiver. Advancing the control further clockwise will increase the volume.

② SQL control

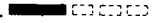
The SQL control is used to eliminate noise in the FM-N mode during no signal periods. Normally this control is adjusted clockwise until the noise just disappears, and the BUSY indicator (SIGNAL ) goes off. This point is commonly known as the Squelch Threshold point. For scan operations this control must be set to the threshold point. When an incoming signal is weak

or unstable, readjust the SQL control for optimum reception.

③ PHONE jack

Output terminal for earphone. The built-in speaker is disabled when the earphone jack is inserted into this jack. Use a subminiature plug.

④ VFO/M.ch (Memory channel) key

This key is used to switch between the VFO and Memory channel modes.

⑤ SCAN Key

This key is used to start and stop scanning.

⑥ MSG Key

This key is used to enter or recall a message.

⑦ **Tuning control**

This control is used to select the desired receive frequency, Memory channel, Scan direction, and MESSAGE character.

⑧ **UP/DWN keys**

These keys are used to step increase or decrease the desired receive frequency, Memory channel, Scan direction, and MESSAGE digit.

⑨ **Numeric keys
in VFO mode:**

Press the ENTER key and then these keys to enter a frequency directly.

Press these keys to recall a programmable band.

in M.ch mode:

Press these keys and then the ENTER key to enter a Memory channel directly.

**in MESSAGE
entry mode:**

Press these keys (1 ~ 7) to enter a symbol.

⑩ **STEP key
in VFO mode:**

This key is used to select the Frequency step.

Pressing the key during the AUTO mode will release the AUTO mode function.

in M.ch mode:

This key is used to specify or release the Memory Channel to be locked out during scan operations.

⑪ **MODE key**

This key is used to select the MODE.

⑫ **M key
in VFO mode:**

This key is used to enter a frequency into a Memory channel.

in M.ch mode:

This key is used to transfer a Memory channel frequency into VFO mode. (MEMORY SHIFT)

⑬ **C key**

This key is used to release SCAN, and Memory Entry, and to clear a frequency selection or Memory channel selection when using the numeric keys.

⑭ **S. SEL key**

This key is used to select the desired SCAN mode.

⑮ **BEEP key**

This key is used to turn the Audio confirmation tones ON and OFF.

⑯ **ENTER key
in VFO mode:**

This key is used to begin the direct keyboard input of the operating frequency using the numeric keys.

in M.ch mode:

This key is used to directly input the Memory channel number using the numeric keys.

LCD display

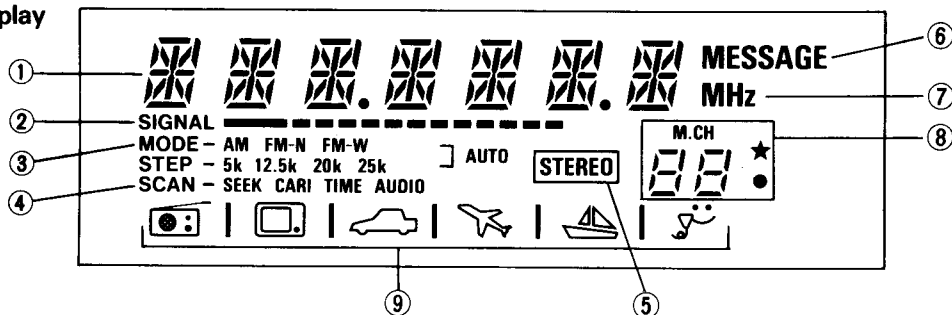

① Frequency display

Displays the receive frequency, and Memory Message.

② SIGNAL

BUSY indicator

This level meter indicates the relative input signal strength.

On whenever the squelch is open in the FM-N mode.

③ MODE - AM FM-N FM-W STEP - 5k 12.5k 20k 25k] AUTO

Displays the selected MODE and Frequency STEP.

④ SCAN - SEEK CARI TIME AUDIO

Displays the selected Scan-Resume condition. Blinks ON and OFF when the scan function has been selected.

⑤ STEREO

ON when receiving FM radio broadcasts.

⑥ MESSAGE

On after pressing the MSG key and when a message is displayed.

⑦ MHz

On whenever a receive frequency is displayed.

⑧

On whenever the M.CH mode is selected. Blinks ON and OFF during Memory channel selection when using numeric keys.

M.CH
88

On alone when Programmable Band is selected.

On in conjunction with the Memory channel number when the channel has been locked out.

On when the Memory has message.

Displays the selected Memory Channel. Blinks ON and OFF during Memory Entry.

⑨ Symbol:

On when the appropriate frequency is selected in AUTO mode.
On when selected in Message Memory mode.

REAR panel

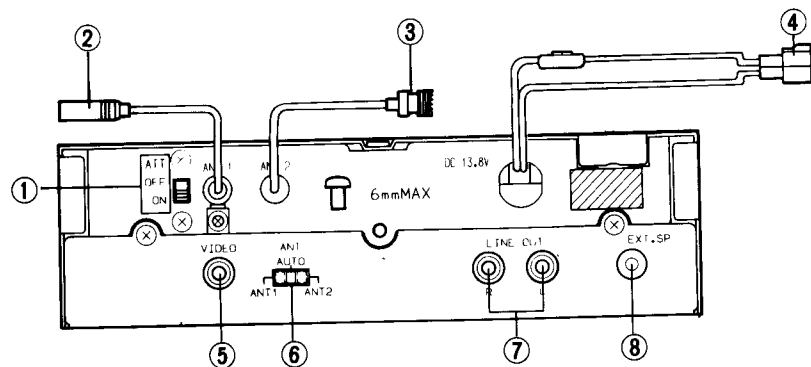

① ATT switch

The signal level from ANT 1 connector is attenuated when this switch is activated. When the signal is very strong, the signal should be attenuated to prevent distortion of the signal. Turn the switch OFF when the signal is very weak.

② ANT 1 connector

This connector should be attached to a suitable mobile antenna for receiving.

③ ANT 2 connector

This connector should be attached to a suitable multi-band antenna or single band antenna.

④ DC power connector

This connector is used to connect the 13.8 VDC power supply.

⑤ VIDEO connector (U.S.A. version)

This connector is used to connect a television monitor to receive T.V.

⑥ ANT switch

broadcasts, or to connect a VIDEO tape recorder.

This switch is used to select the appropriate antenna, ANT 1, AUTO or ANT 2.

In AUTO position, the antenna is automatically selected as follows:

ANT 1: AM $500 \leq \text{frequency} \leq 1630$ kHz

FM $87.5 \leq \text{frequency} \leq 108.1$ MHz

ANT 2: OTHERS

⑦ LINE OUT connectors

These connectors are used to attach the AUX connector or TUNE connector of a STEREO receiver/amplifier to receive stereo broadcasts.

⑧ EXT. SP jack

This jack is for connection of an external speaker.

4-2. RECEIVER OPERATION

The Receiver will supply audio confirmation when a function is activated.

4-2-1. Reception

1. Connect the power supply and the antennas, and then set the switches and controls as follows:

POWER (VOL) control: OFF (Fully counterclockwise)
POWER switch of the DC power supply (Fixed Station)
: OFF
SQL control : Fully counterclockwise

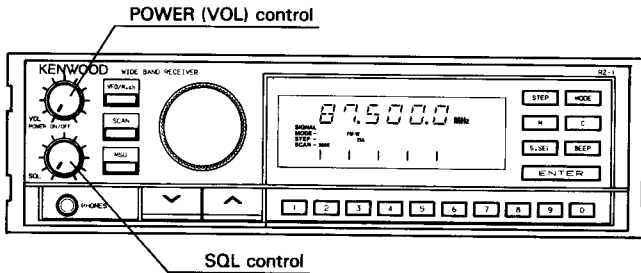



Fig. 1

2. Turn ON the DC power supply and then turn the receiver's power switch ON. After a few second the display panel will indicate as shown in Fig. 1 and some control's and key's lights will turn on.

Note:

If the display is not as shown Fig. 1 reset the microprocessor using the procedure in Section 4-3-2 Page 18 ~ 19.

3. Turn the VOL control clockwise until a signal or noise is heard.

4. Rotate the Tuning control and select an open channel. Then turn the SQL control clockwise until the noise disappears and the BUSY indicator (SIGNAL ) goes OFF (Threshold point). (FM-N only)
5. Select the desired frequency when a signal is received, the BUSY indicator will turn ON and S-meter will deflect.
6. To turn off the receiver, turn off the receiver's POWER switch before you turn off the power supply, or if in a vehicle, before you stop the engine.

4-2-2. Frequency Selection

Frequency can be changed in the VFO mode. The selected frequencies can be stored in the Memory channels. (See Memory Entry page 19.)

A. VFO mode

To select the desired operating frequency in the VFO mode rotate the Tuning control, press the UP/DWN keys, or enter the desired frequency directly by using the ENTER key and numeric keys.

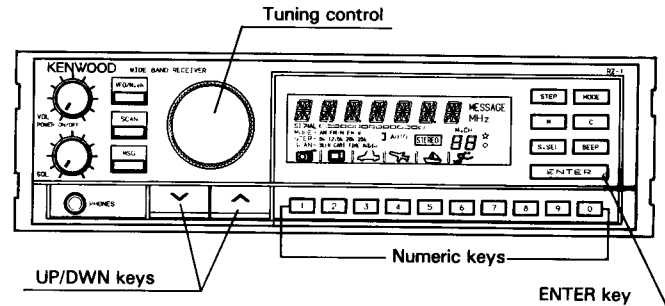

- **Direct Frequency Entry**

1. Press the ENTER key. The LCD display will show

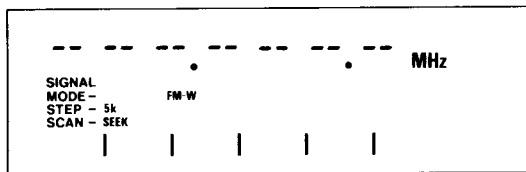

2. Enter the frequency to the nearest kHz. For example to enter the frequency of 145.220 MHz you would press 1, 4, 5, 2, 2. The LCD display would then show:

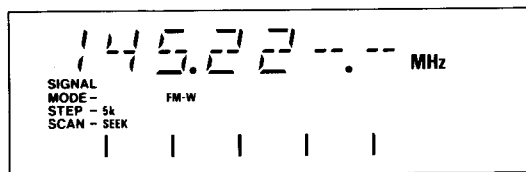

3. Press the ENTER key to complete the Frequency selection. The LCD display will show:

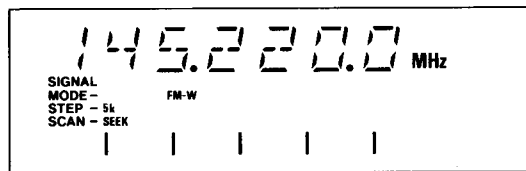

The 10 kHz, 1 kHz, and 0.5 kHz frequency digits will be affected by the current frequency step size.

- **B. M.ch mode**

The desired Memory Channel can be selected using the same controls described in the VFO mode. To select a Memory Channel, first press the VFO/M.ch key to select the Memory Channel mode.

Rotate the Tuning control, press the UP/DWN keys, or enter a frequency directly by using the numeric keys and the ENTER key.

- **Direct Memory Channel Recall**

1. Press the VFO/M.ch key. The LCD display will show:

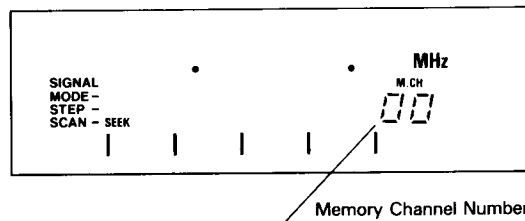

If M.ch 00 had been previously programmed, the frequency will appear the display.

2. Press the desired numeric key. For example to recall the Memory channel 35 you would press 3 and then 5 keys.

The LCD display will show:

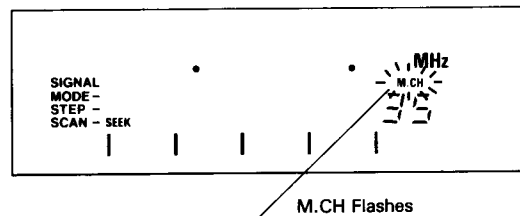

3. Press the ENTER key to complete the Memory Channel recall. The LCD display will show:

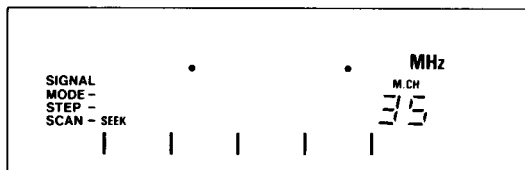

(M.ch 35 had not been previously programmed.)

4-2-3. MODE Selection

You must select the appropriate mode using the MODE key. Each time you press the MODE key the receiver will advance from AM to FM-N to FM-W to AUTO mode, etc. (AUTO mode cannot be selected in M.ch mode, or programmable band mode.)

A. AUTO mode selection

The AUTO mode function automatically selects the MODE according to the selected frequency as shown below.

U.S.A version

Frequency Range	000.500 } 001.620	001.630 } 087.495	087.500 } 108.000	108.100 } 824.000
MODE	AM	AM	FM-W	FM-N
F. STEP	*1 10 kHz	5 kHz	100 kHz	*2 VFO STEP
Symbol		—		—

European version

Frequency Range	000.504 } 001.629	001.630 } 087.495	087.500 } 108.050	108.100 } 905.000
MODE	AM	AM	FM-W	FM-N
F. STEP	*1 9 kHz	5 kHz	50 kHz	*2 VFO STEP
Symbol		—		—

Other market

Frequency Range	000.504 } 001.629	001.630 } 087.495	087.500 } 108.000	108.100 } 905.000
MODE	AM	AM	FM-W	FM-N
F. STEP	*1 9 kHz	5 kHz	100 kHz	*2 VFO STEP
Symbol		—		—

*1 The Frequency STEP size can be changed by using the following procedure.

1. Turn the POWER switch OFF.
2. Press and hold the 0 key for 10 kHz step, or the 9 key for 9 kHz step.
3. Turn ON the POWER switch and then release the key.

*2 The VFO STEP will be the VFO STEP that was selected before the AUTO mode.

B. MANUAL mode selection

The MANUAL mode function allows you to set the desired frequency MODE and STEP.

STEP size selection

The Frequency STEP size can be changed in MANUAL mode. If in the AUTO mode, the mode will be released. Each time you press the STEP key the receiver will advance from 5 k to 12.5 k to 20 k to 25 k step.

4-3. MEMORY

4-3-1. Microprocessor memory back-up

A lithium battery is contained in the receiver to retain memory. Turning off the POWER switch, disconnecting the power cable, or a power failure will not erase the memory. The battery should last for approximately ten years. When the battery discharges, an erroneous display may appear in the display.

Lithium battery replacement should be performed by an authorized KENWOOD service facility; either your KENWOOD dealer, or the factory, since this unit contains CMOS type circuitry.

4-3-2. Microprocessor Initialization

- Initial state of the microprocessor from the factory.

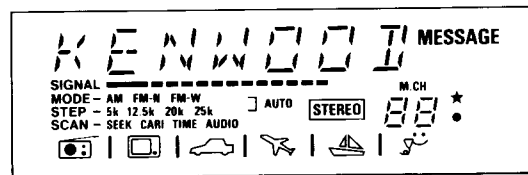

After a few second

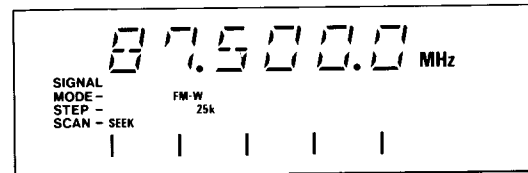

• Microprocessor Initialization

When you want to erase all programmed data, or if the display should show erroneous information, you should initialize (reset) the microprocessor using the following procedure.

There are two methods for resetting the microprocessor.

- A. Rest all user programmed data except the contents of the Memory Channels.
 1. Turn the POWER switch OFF.
 2. Press and hold the ENTER key and turn on the POWER switch.
 3. Release the ENTER key.
- B. Reset all user programmed data including the contents of the Memory Channels.
 1. Turn the POWER switch OFF.
 2. Press and hold the M key and UP (↖) key and turn on the POWER switch.
 3. Release the M key and UP (↖) key.

4-3-3. Memory Channel

This receiver provides 100 Memory Channels (00 ~ 99). In addition to serving as normal memory channel some of the memory channels are used to specify other parameters. The functions of these Memory Channels are described below.

- * Memory Channel 10, 20, 30, 40, 50, 60, 70, 80, 90, and 00 are used to store the limit for the Programmable Band and Programmable Band Scan function.
- * Memory Channel 19, 29, 39, 49, 59, 69, 79, 89, 99, 09 are used to store the limit for the Programmable Band and Programmable Band Scan function.

4-3-4. Memory Contents

Each Memory Channel is capable of storing the frequency, mode, symbol (◻, ◻,), and message. (Refer to Message Memory page 25.)

4-3-5. Memory Entry

Memory Entry must be begun in the VFO mode.

1. Press the VFO/M.ch key to select the VFO mode.

Select the desired frequency using the Tuning control, UP/DWN key, or the numeric keys and the ENTER key. Select the appropriate MODE.
(For example 145.220 MHz, AUTO mode)

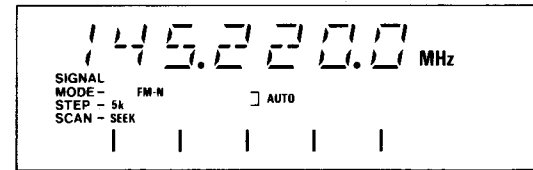

2. Press the M key. The last Memory channel that was previously recalled will appear and the channel number will flash.
(For example M.ch 00 : empty)

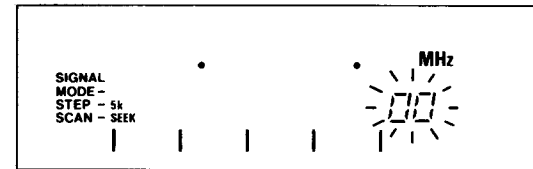

3. Select the desired Memory Channel using the Tuning control, UP/DWN key, or the numeric keys.
(For example M.ch 40;

Press the 4 key, and then the 0 key.)

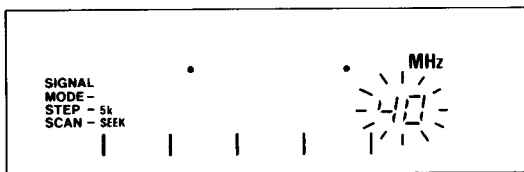

4. Press the M key again. The Memory channel number will turn OFF. The receiver will return to VFO mode.

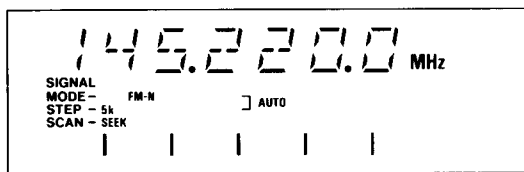

5. Press the VFO/M.ch key to confirm the entered Memory contents.

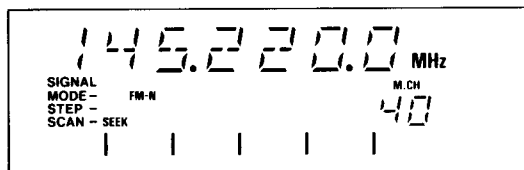

4-3-6. Memory Recall

Please refer to "Frequency Selection B. M.ch mode" page 16.

4-3-7. Programmable Band

The Programmable Band function allows you to define the frequency range. The range is determined by the frequency in Memory Channel-0 and -9 as follows.

The corresponding numeric key can be used to directly recall the frequency in Memory Channel-0. The programmable Band indicator is the ★ without the Memory Channel number.

Key	Memory Channel	Key	Memory Channel
1	10 : 19	6	60 : 69
2	20 : 29	7	70 : 79
3	30 : 39	8	80 : 89
4	40 : 49	9	90 : 99
5	50 : 59	0	00 : 09

For example

1. Press the VFO/M.ch key to select the VFO mode.
Select the lower frequency, and the desired MODE.
(For example 145.220 MHz, AUTO mode)

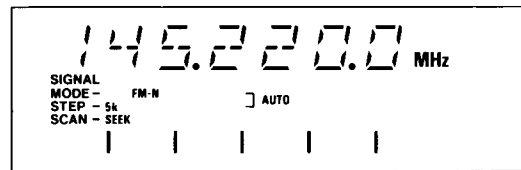

2. Press the M key.

Select the -0 desired low end storage location. (For example M.ch 40)

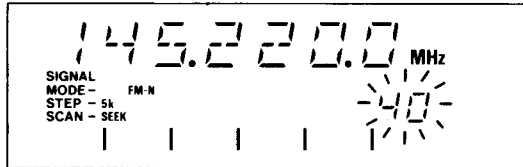

3. Press the M key to enter the data. The receiver will return to the VFO mode.

Select the upper frequency. (For example 146.000 MHz)

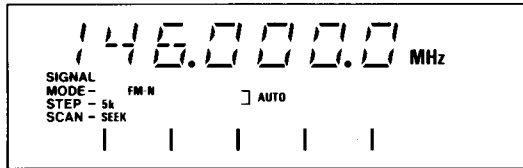

4. Press the M key.

Select the -9 desired high end storage location that corresponds to the selected lower limit.

(For example M.ch 49)

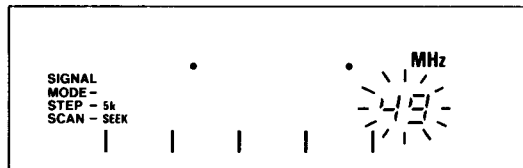

5. Press the M key to enter the data. The receiver return to the VFO mode.

6. Press the 4 key. The frequency of M.ch 40 will appear in the LCD display. The radio will select the VFO mode.

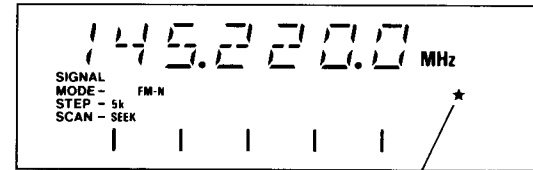

Programmable Band Mark (★) is lit.

7. Rotate the Tuning control to confirm the frequency range.

8. Press the ENTER key twice to release the Programmable Band function.

Note:

- * If either storage location has no contents, the numeric key cannot recall the Programmable Band.
- * The AUTO mode cannot be selected.

4-3-8. Memory Shift

This feature transfers the memory channel data to the VFO. This will allow you to alter the frequency without changing the contents of the memory channel.

1. Press the VFO/M.ch key to select the M.ch mode.
2. Select the desired Memory Channel number using the Tuning control, the UP/DWN keys, or the numeric keys and the ENTER key. (For example M.ch 40)

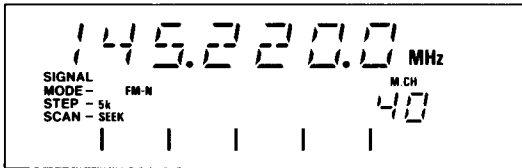

3. Press the M key. The data will be transferred to the VFO mode.
4. Rotate the Tuning control to select the desired frequency.

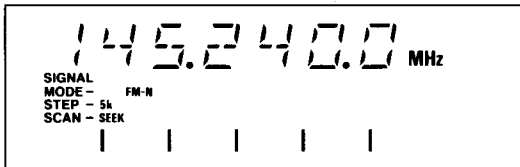

4-4. SCAN

Scan is used to sample the band activity automatically.

4-4-1. SCAN Option

1. ALL BAND SCAN

Scan proceeds over the entire band. (VFO mode)

2. PROGRAMMABLE BAND SCAN

The Scan frequency range is determined by the Programmable band function. (VFO mode)

3. MEMORY CHANNEL SCAN

Scan proceeds thru those Memory Channels that actually have data and have not been locked out. (M.ch mode)

4. MEMORY CHANNEL GROUP SCAN

The 100 Memory Channels are divided into 10 groups (10 to 19, 20 to 29, 90 to 99, 00 to 09). The Scan proceed thru the selected Memory channel group. (M.ch mode)

If you select the FM-N mode (include the AUTO mode), adjust the SQL control to the threshold point, in order for scan to operate properly.

4-4-2. Hold/Resume Condition

The receiver will stop on a busy channel.

1. SEEK Operated Scan

Scan will not resume until the SCAN key is pressed again.

2. CARRIER Operated Scan

Scan will hold as long as the signal is present, and resume if the signal drops out.

3 TIME Operated Scan

Scan will resume approximately 6 seconds after stopping even if the station is still present.

4. AUDIO Operated Scan

During the FM-N mode Scan will stop by audio signal and will resume approximately 6 seconds afterwards even if the station is still present.

During the AM and FM-W mode the scan is the same as Time Operated Scan.

4-4-3. All Band Scan

1. Press the VFO/M.ch key to select the VFO mode.
2. Press the S. SEL key to select the Scan MODE.
3. Press the SCAN key to initiate SCAN. The selected Scan mode indicator will flash OFF and ON as a visual reminder that the receiver is scanning.

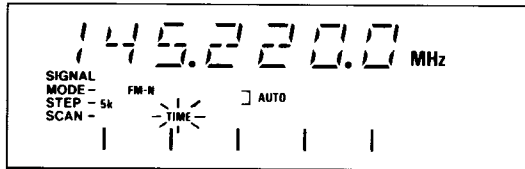

4. Press the SCAN key again or the C key to clear scanning.

4-4-4. Programmable Band Scan

1. The scan limit frequency pairs must be stored in the following Memory Channels.

Key	Memory Channel	Key	Memory Channel
1	10 : 19	6	60 : 69
2	20 : 29	7	70 : 79
3	30 : 39	8	80 : 89
4	40 : 49	9	90 : 99
5	50 : 59	0	00 : 09

2. Press the VFO/M.ch key to select the VFO mode.
3. Press the S. SEL key to select the Scan mode.
4. Press the desired recall key using the numeric keypad.
(For example press the 4 key.)

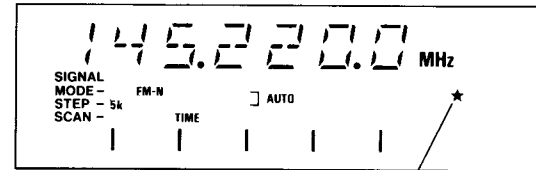

Programmable Band indicator

- The Programmable Band indicator will light.
5. Press the SCAN key to initiate SCAN. The selected Scan mode indicator will flash OFF and ON as a visual reminder that the receiver is scanning.
6. Press the SCAN key again or the C key to clear scanning.
7. Press the ENTER key twice to return to normal VFO mode.

Note: _____
 If either channel is empty, the numeric keys will not be able to recall the Programmable band.

4-4-5. Memory Channel Scan

1. Press the VFO/M.ch key to select the M.ch mode.
2. Press S. SEL key to select the Scan mode.
3. Press the SCAN key to initiate SCAN. The selected Scan mode indicator will flash OFF and ON as a visual reminder that the receiver is scanning.
4. Press the SCAN key again or the C key to clear scanning.

4-4-6. Memory Channel Group Scan

1. Press the VFO/M.ch key to select the M.ch mode.
2. Press the S.SEL key to select the Scan mode.
3. Press the desired group number key using the numeric keypad.

Group number	Memory Channel	Group number	Memory Channel
1	10 ~ 19	6	60 ~ 69
2	20 ~ 29	7	70 ~ 79
3	30 ~ 39	8	80 ~ 89
4	40 ~ 49	9	90 ~ 99
5	50 ~ 59	0	00 ~ 09

4. Press the SCAN key to initiate SCAN. The selected scan mode indicator will flash OFF and ON as a visual reminder that the receiver is scanning.
5. Press the SCAN key again or the C key to clear scanning.

SCAN DIRECTION

Scan will begin in an upwards direction. You can reverse the direction by rotating the Tuning control counterclockwise, or by pressing the UP/DWN keys.

4-4-7. Memory Channel Lockout

The Memory Channel Lockout function allows you to temporarily skip unwanted Memory Channels during the Memory Channel Scan mode.

1. Press the VFO/M.ch key to select the M.ch mode.
2. Select the Memory Channel that you wish to skip by using the MAIN Tuning control.
3. Press the STEP key.

A star (★) will appear to the left of the Memory Channel number. This indicates the Memory Channel will be skipped during Memory Channel Scan operations.

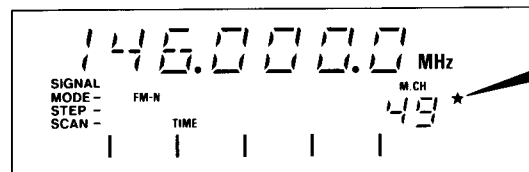

4. Repeat steps 2 and 3 to lock out any other Memory Channels that you want to skip.

5. To cancel the lockout, select the desired Memory Channel as described in steps 1, 2, and 3 above.

The star (★) will go out. The Memory Channel will now be scanned normally.

Note: _____

If you enter new data into a locked out Memory Channel, the lock out will be released.

4-5. MESSAGE MEMORY

Each Memory channel can store a seven character message, in addition to the normal memory channel contents.

4-5-1. Message Entry

Message Entry must be performed in the VFO mode.

1. Press the VFO/M.ch key to select the VFO mode.
Select the desired frequency using Tuning control, UP/DWN key, or numeric keys and ENTER key.
Select the appropriate MODE.
(For example 145.220 MHz, AUTO mode)

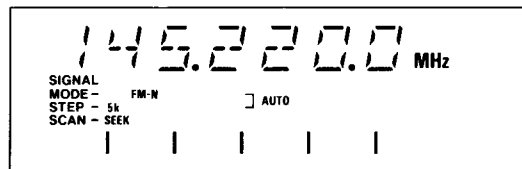

2. Press the M key. The previous Memory Channel data will appear and the channel number will flash.
(For example M.ch 49)

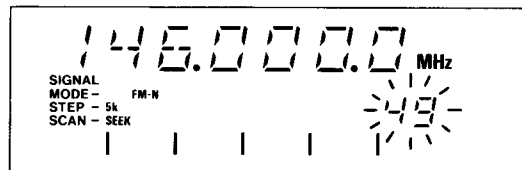

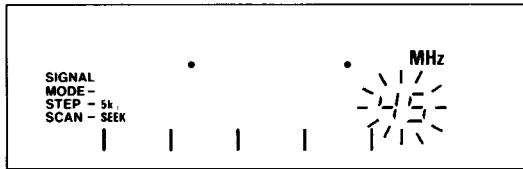

3. Select the Memory channel you want to enter a message on using the Tuning control, UP/DWN key, or the numeric keys. (For example M.ch 45; Press the 4 key, and then the 5 key.)



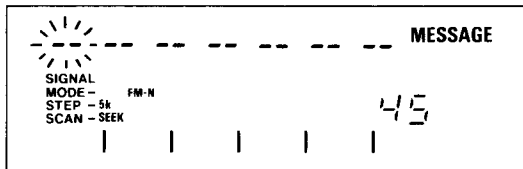

4. Press the MSG key.
The MESSAGE indicator will light and the leftmost message cursor will flash ON and OFF.

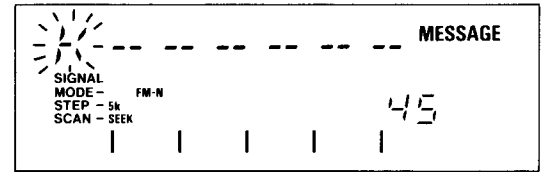

5. Rotate the Tuning control to select the desired character as shown below. ( : blank)

A B C D E F G H I J K L M N O P Q R S T U V W X
Y Z , \ / \ * _ φ 1 2 3 4 5 6 7 8 9 - + / =  



6. Press the UP () key to go ahead, and the DWN () key to return backward.
For example select "KENWOOD"

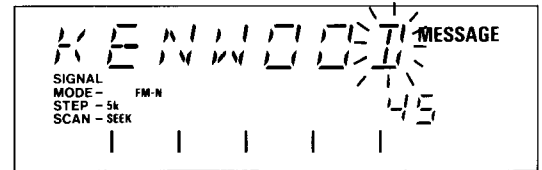

7. You may press one of the 1~7 numeric keys to enter the following symbols.



For example press the 3 key.

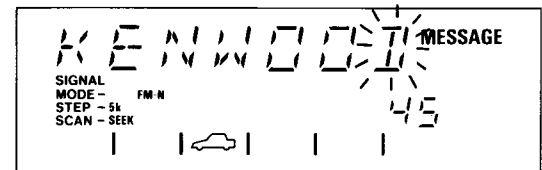

- Press the M key again. The Memory Channel number will turn OFF. And the receiver will return to the VFO mode.

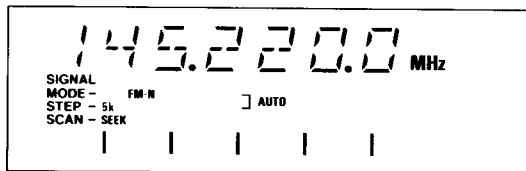

- Press the VFO/M.ch key to confirm the information.

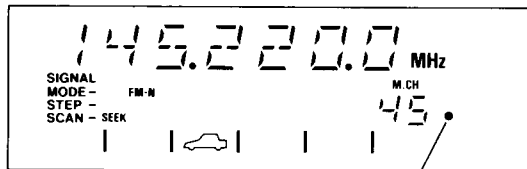

MESSAGE Memory indicator

A MESSAGE Memory indicator will light, to remind you a message has been stored for that Memory channel.

- Press the MSG key to review the Message.

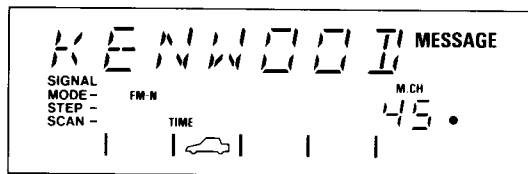

- Press the VFO/M.ch key to return to the VFO mode again.

4-5-2. Message Memory Recall

A. M.CH mode

- Press the VFO/M.ch key to select the M.ch mode.
- Rotate the Tuning control to select the desired Memory channel. (For example M.ch 45)

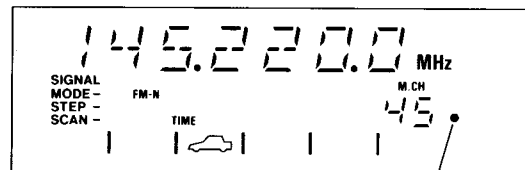

MESSAGE Memory indicator

- Press the MSG key to display the message.

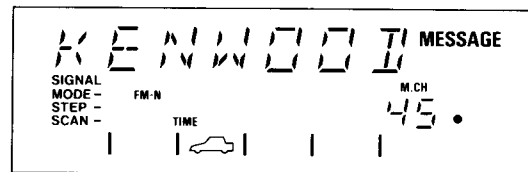

- * Rotate the Tuning control, to select the desired Message Memory channel.
- * Press the SCAN key, the receiver will initiate Scan and will display Messages, rather than Frequency data.
- * Press the desired numeric key and then press the SCAN key, the receiver will initiate Memory Channel Group Scan of the Message display.

B. VFO Mode

1. Press the VFO/M.ch key to select the VFO mode.
2. Rotate the Tuning control to select a desired frequency.
3. Press the MSG key.

The receiver will display the Message of the Memory channel that has the same frequency that appears in the display.

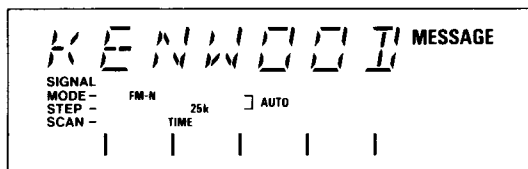

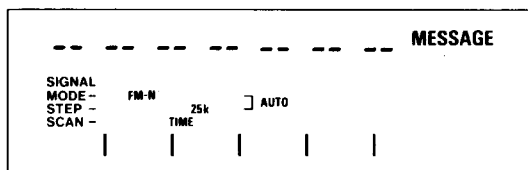

If more than 2 Memory Channels have the same frequency as the VFO, the message of the lower memory channel will be displayed.

If the Memory channel has no message, the display will be as shown below.



The message display will not change if there is no data stored in the associated memory channel (i.e. channel is empty).

Note:

Symbol ( ,  , ) will not change during this operation.

4. Press the MSG key again to return to the VFO mode.